

EASY

LIGHTING SOLUTIONS





Illudesign, ce sont des femmes et des hommes qui se regroupent autour d'une passion commune : l'éclairage.

Avec EASY Lighting Solutions, nous voulions donner à l'utilisateur de ce catalogue, toute la matière qui lui permettra de donner vie à ses projets lumineux comme il les avait imaginé, où mieux... comme il n'avait jamais osé les imaginer.

Cette sélection de produits s'adresse aux professionnels soucieux de conseiller des luminaires de qualité au meilleur prix à leurs clients; des luminaires qui donneront toute satisfaction dès l'étape du placement.

Cette sélection s'adresse aussi aux particuliers désireux de doter leurs projets d'éclairage d'une réelle plus-value en termes de fonctionnalité, de fiabilité, d'originalité et de respect du budget fixé.

De manière générale, Easy Lighting Solutions présente une sélection étudiée de luminaires répondant au mieux aux exigences esthétiques et techniques que pose la grande majorité des projets d'éclairage à l'heure actuelle.

Toute notre équipe, riche d'une cinquantaine de collaborateurs, est là pour vous accompagner au mieux à chaque étape de vos projets. Que ce soit dès la conception avec nos éclairagistes, chargés d'étude, architectes d'intérieur, commerciaux B2B... jusqu'à la livraison, toute notre équipe se mobilise pour vous.

Ensemble, unissons nos talents.

L'équipe Illudesign



	STRIPS LED & PROFILES	4
	SPOTS ENCASTRÉS	40
	DOWLIGHTS TERTIAIRE/RETAIL	82
	LED PANELS.....	94
	PLAFONNIERS	100
	SPOTS APPARENTS	122
	SUSPENSIONS	152
	APPLIQUES MURALES	194
	LAMPES À POSER	226
	RAILS & TRACK LIGHTS	246
	LUMINAIRES AVEC DÉTECTEUR.....	290
	BALISAGES INTÉRIEURS	310
	ENCASTRÉS DE SOL.....	316
	BORNES EXTÉRIEURES	328
	SPOTS À PIQUER & ACCESSOIRES	344
	APPLIQUES EXTÉRIEURES.....	356
	PLAFONNIERS ET ENCASTRÉS EXTÉRIEURS	396
	PROJECTEURS EXTÉRIEURS	406
	SECOURS	418
	ARMATURES INDUSTRIELLES.....	428
	SPOTS DE CHANTIER	436
	GESTION DE L'ÉCLAIRAGE ET ALIMENTATIONS.....	442
	SOURCES	456
	UTILITAIRES.....	462

STRIPS LED & PROFILES

PAGES 4 À 39

Les strips led permettent d'éclairer de manière uniforme tout en s'intégrant très facilement à l'architecture ou dans des éléments de mobilier. Placés dans des meubles hauts de cuisine pour éclairer le plan de travail, dans un profilé au sol dans un couloir, à l'intérieur d'un dressing ou encore dans une niche dans la salle de bain avec variation de couleurs pour un effet luminothérapie, les strips led sont devenus incontournables parmi les techniques d'éclairage actuelles.



STRIPS LED & PROFILES



CONTROLEURS & RÉCEPTEURS

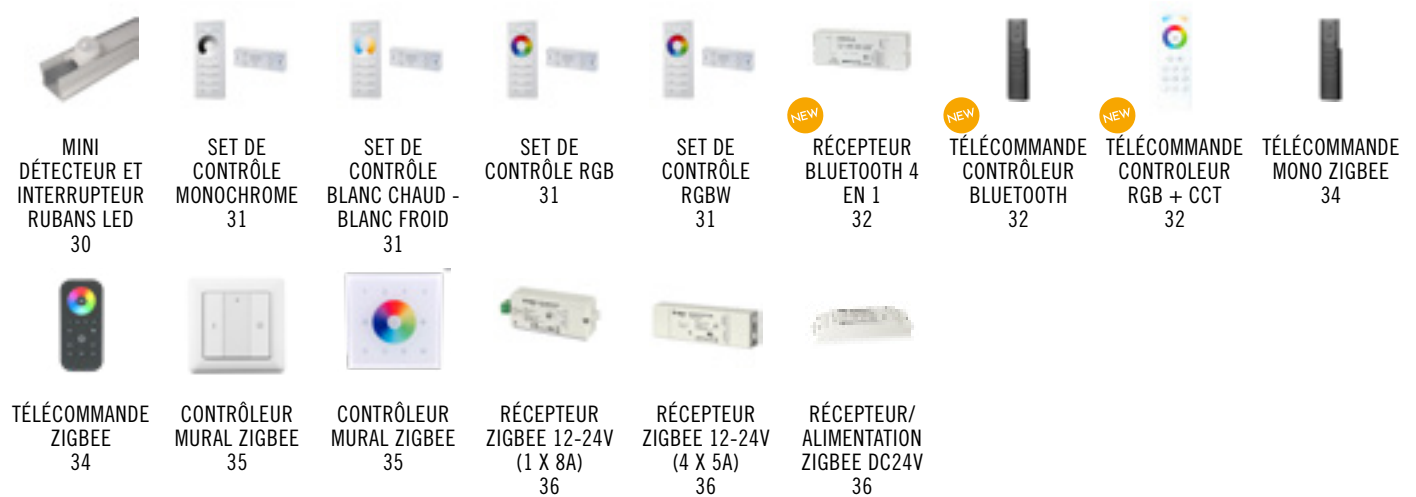

REGLETTES LED ET SOUS MEUBLES



MAGNETICA
38

REGULED
39

ELIR
39

COB 528

3
ANS

IP20

180°

IRC
80A++
A

24V

**Mono - COB**

- Innovation technologique LED COB
- Angle de diffusion de 180°
- Eclairage diffus et uniforme
- Excellente résistance aux variations de tension
- Flexible
- Pour éclairage en lignes continues

Installation :

Maximum 10m linéaire
Fixation adhésive 3M

Convertisseurs 24V voir pages 444 - 445**Contrôleurs voir pages 30 - 36**

NEW

PUISSANCE/M	✂ SÉCABILITÉ	T°	FLUX/M	LONGUEUR	LARGEUR MM	RÉF. ID	PRIX HTVA
15W	45 MM	2200°K	1220 LM	5 M	10	ID/03546803	€ 140,00
				10 M	10	ID/03546804	€ 278,00
		2700°K	1300 LM	5 M	10	ID/03546805	€ 140,00
				10 M	10	ID/03546806	€ 278,00
		3000°K	1380 LM	5 M	10	ID/03546807	€ 140,00
				10 M	10	ID/03546808	€ 278,00
		4000°K	1600 LM	5 M	10	ID/03546809	€ 140,00
				10 M	10	ID/03546810	€ 278,00



2216 - IP20

5
ANS

IP20

120°

IRC
≥90A++
AA++
A

24V

24V

24V



Mono - SMD2216

- Diodes LED de taille réduite
- 3 puissances pour de nombreuses applications
- Pour éclairage résidentiel intérieur : gorges lumineuses, étagères, meubles...

Installation :

Maximum 10m linéaire
Fixation adhésive 3M

Convertisseurs 24V voir pages 444 - 445

Contrôleurs voir pages 30 - 36

NEW

PUISSANCE/M	LED/M	✂ SÉCABILITÉ	T°	FLUX/M	LONGUEUR	LARGEUR MM	RÉF. ID	PRIX HTVA
4,8W	60	50 MM	2700°K	360 LM	5 M	8	ID/03546753	€ 44,00
					5 M	8	ID/02199765	€ 44,00
			3000°K	384 LM	10 M	8	ID/02199766	€ 80,00
					5 M	8	ID/02199767	€ 44,00
			4000°K	417 LM	10 M	8	ID/02199768	€ 80,00
					5 M	8	ID/02845292	€ 60,00
9,6W	120	50 MM	2700°K	710 LM	5 M	8	ID/02199769	€ 60,00
					5 M	8	ID/02199770	€ 118,00
			3000°K	730 LM	10 M	8	ID/02199771	€ 60,00
					5 M	8	ID/02199772	€ 118,00
			4000°K	770 LM	10 M	8	ID/02199773	€ 112,00
					5 M	10	ID/02199774	€ 220,00
19,2W	240	25 MM	3000°K	1365 LM	5 M	10	ID/02233007	€ 112,00
					10 M	10	ID/02233008	€ 220,00
			4000°K	1440 LM	5 M	10	ID/02233007	€ 112,00
					10 M	10	ID/02233008	€ 220,00

2216 - IP66

5
ANS

IP66

120°

IRC
≥90A++
A

24V

24V

24V

24V

24V



Mono - SMD2216

- Diodes LED de taille réduite
- 3 puissances pour de nombreuses applications
- Pour éclairage résidentiel intérieur ou extérieur en zones humides

Installation :

Maximum 10m linéaire
Fixation adhésive 3M

Convertisseurs 24V voir pages 444 - 445

Contrôleurs voir pages 30 - 36

NEW

PUISSANCE/M	LED/M	✂ SÉCABILITÉ	T°	FLUX/M	LONGUEUR	LARGEUR MM	RÉF. ID	PRIX HTVA
4,8W	60	100 MM	2700°K	360 LM	5 M	9	ID/03546754	€ 61,00
			3000°K	384 LM	5 M	9	ID/03546755	€ 61,00
			4000°K	417 LM	5 M	9	ID/03546756	€ 61,00
9,6W	120	50 MM	2700°K	710 LM	5 M	9	ID/03546759	€ 92,00
			3000°K	730 LM	5 M	9	ID/03546760	€ 92,00
			3000°K	730 LM	10 M	9	ID/03546762	€ 180,00
			4000°K	770 LM	5 M	9	ID/03546761	€ 92,00
			4000°K	770 LM	10 M	9	ID/03546763	€ 180,00
			4000°K	770 LM	10 M	9	ID/03546763	€ 180,00
19,2W	240	25 MM	3000°K	1365 LM	5 M	11	ID/03546788	€ 170,00
			3000°K	1365 LM	10 M	11	ID/03546786	€ 330,00
			3000°K	1365 LM	5 M	11	ID/03546789	€ 170,00
			4000°K	1440 LM	10 M	11	ID/03546787	€ 330,00

2835 - IP20

5
ANS

IP20

120°

IRC
≥90A++
AA++
A

24V

24V

24V



Mono - SMD2835

- Diodes LED ultra-performantes, qualité PREMIUM
- Nombreuses versions et déclinaisons disponibles
- Pour des applications professionnelles intérieures : commerces, horeca, secteur tertiaire...

Installation :

Maximum 10m linéaire
Fixation adhésive 3M

Convertisseurs 24V voir pages 444 - 445

Contrôleurs voir pages 30 - 36

NEW

PUISSANCE/M	LED/M	✂ SÉCABILITÉ	T°	FLUX/M	LONGUEUR	LARGEUR MM	RÉF. ID	PRIX HTVA
			2700°K	1240 LM	5 M	10	ID/02845289	€ 70,00
14,4W	60	100 MM	3000°K	1300 LM	5 M	10	ID/02845290	€ 70,00
			4000°K	1350 LM	5 M	10	ID/02845291	€ 70,00
			2700°K	1500 LM	5 M	10	ID/03546780	€ 115,00
14,4W	210	33 MM	3000°K	1550 LM	5 M	10	ID/03546781	€ 115,00
			4000°K	1650 LM	5 M	10	ID/03546782	€ 115,00
			2700°K	2485 LM	5 M	10	ID/02867344	€ 120,00
28,8W	120	50 MM	3000°K	2550 LM	5 M	10	ID/02867345	€ 120,00
			4000°K	2700 LM	5 M	10	ID/02867346	€ 120,00



2835 IP65-67

5
ANS

120°

IRC
≥90A++
A

24V

**Mono - SMD2835**

- Diodes LED ultra-performantes, qualité PREMIUM
- Nombreuses versions et déclinaisons disponibles
- Pour des applications professionnelles intérieures ou extérieures : commerces, horeca, secteur tertiaire...

Installation :

Maximum 10m linéaire
Fixation adhésive 3M

Convertisseurs 24V voir pages 444 - 445**Contrôleurs voir pages 30 - 36**

NEW

PUISANCE/M	LED/M	✂ SÉCABILITÉ	IP	T°	FLUX/M	LONGUEUR	LARGEUR MM	RÉF. ID	PRIX HTVA
				2700°K	1240 LM	5 M	10	ID/01784695	€ 95,00
13,2W	60	100 MM	IP65	3000°K	1300 LM	5 M	10	ID/02554244	€ 95,00
				4000°K	1350 LM	5 M	10	ID/01784696	€ 95,00
				2700°K	1500 LM	5 M	12	ID/03546783	€ 140,00
14,4W	210	33 MM	IP67	3000°K	1550 LM	5 M	12	ID/03546784	€ 140,00
				4000°K	1650 LM	5 M	12	ID/03546785	€ 140,00
				2700°K	2485 LM	5 M	10	ID/01784697	€ 137,00
26,4W	120	50 MM	IP65	3000°K	2550 LM	5 M	10	ID/02554245	€ 137,00
				4000°K	2700 LM	5 M	10	ID/01784698	€ 137,00



ARCHI BICOLOR

5
ANS

IP65

120°

IRC
85A++
A

24V



BICOLOR - SMD 5050

- Variation de la chaleur de la lumière du blanc chaud au blanc neutre
- Pour des applications résidentielles et commerciales intérieures ou extérieures

Installation :

Maximum 10m linéaire

Fixation adhésive 3M

Convertisseurs 24V voir pages 444 - 445

Contrôleurs voir pages 30 - 36



NEW

PUISSANCE/M	LED/M	✂ SÉCABILITÉ	T°	FLUX/M	LONGUEUR	LARGEUR MM	RÉF. ID	PRIX HTVA
13W	60	50 MM	2700 - 4000°K	1070 LM	5 M	10	ID/01194538	€ 166,00
26W	120	50 MM	2700 - 4000°K	2140 LM	5 M	20	ID/01194541	€ 263,00

ARCHI RGB

5
ANS

IP65

120°

A++
A

24V



RGB

- Variation de la couleur de la lumière parmi toutes les couleurs du cercle chromatique
- Pour des applications résidentielles et commerciales intérieures ou extérieures

Installation :

Maximum 10m linéaire

Fixation adhésive 3M

Convertisseurs 24V voir pages 444 - 445

Contrôleurs voir pages 30 - 36



NEW

PUISSANCE/M	LED/M	✂ SÉCABILITÉ	T°	LED SMD	LONGUEUR	LARGEUR MM	RÉF. ID	PRIX HTVA
14,4W	60	100	RGB	5050	5 M	10	ID/01194539	€ 121,00
	120	50	RGB	3838	5 M	10	ID/03546764	€ 175,00
28,8W	120	50	RGB	5050	5 M	20	ID/01194542	€ 263,00

RGB+ BLANC

5
ANS

120°

IRC
>85A++
A

24V

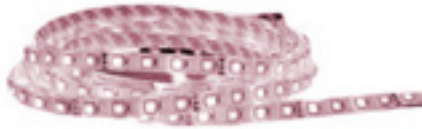

RGB + BLANC

- Variation de la couleur de la lumière parmi toutes les couleurs du cercle chromatique
- Permet l'obtention d'un éclairage blanc « pur » de qualité (3000°k ou 4000°k)
- Permet l'association lumière blanche et couleur pour des résultats colorés pastels
- Pour des applications résidentielles et commerciales intérieures ou extérieures

Installation :

Maximum 10m linéaire
Fixation adhésive 3M

Convertisseurs 24V voir pages 444 - 445

Contrôleurs voir pages 30 - 36

NEW

PUISSANCE/M	LED/M	✂ SÉCABILITÉ	T°	LONGUEUR	LARGEUR MM	RÉF. ID	PRIX HTVA
17,3W	72	100	RGB + 3000°K	5 M	12	ID/03128868	€ 175,00
			RGB + 4000°K	5 M	12	ID/01554732	€ 175,00

RGB + CCT

5
ANS

120°

IRC
>85A++
A

24V



RGB + CCT

- Variation de la couleur de la lumière parmi toutes les couleurs du cercle chromatique
- Permet l'obtention d'un éclairage blanc « pur » de qualité
- Permet de choisir la chaleur de lumière souhaitée (entre 2400-6500°k)
- Permet l'association lumière blanche et couleur pour des résultats colorés pastels
- Pour des applications résidentielles et commerciales intérieures ou extérieures

Installation :

Maximum 10m linéaire
Fixation adhésive 3M

Convertisseurs 24V voir pages 444 - 445

Contrôleurs voir pages 30 - 36

NEW

PUISSANCE/M	LED/M	✂ SÉCABILITÉ	T°	LONGUEUR	LARGEUR MM	RÉF. ID	PRIX HTVA
24W	60	100	RGB + 2400 - 6500°K	5 M	12	ID/03546757	€ 219,00



FOOD - RUBAN ALIMENTAIRE

5
ANS

IP67

120°

A++
A

24V



Mono - SMD3528

- Mise en lumière optimale pour une maximisation des ventes selon le type de produit
- Pour des applications commerciales dans le secteur « food »

Installation :

Maximum 10m linéaire

Fixation adhésive 3M

Convertisseurs 24V voir pages 444 - 445

Contrôleurs voir pages 30 - 36

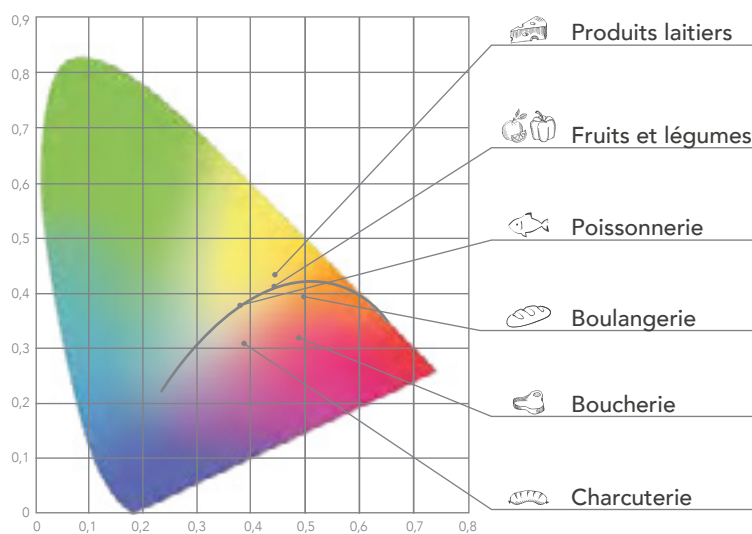

Produits laitiers

Fruits et légumes

Poissonnerie

Boulangerie

Boucherie

Charcuterie

NEW

PUISSANCE/M	LED/M	✂ SÉCABILITÉ	TYPE	FLUX/M	IRC	LONGUEUR	LARGEUR MM	RÉF. ID	PRIX HTVA
14,4W	180	50	PRODUITS LAITIERS	1152 LM	>90	5 M	10	ID/03546772	€ 158,00
			FRUITS & LÉGUMES	1224 LM	>91	5 M	10	ID/03546771	€ 158,00
			POISSONNERIE	1224 LM	>91	5 M	10	ID/03546773	€ 158,00
			BOULANGERIE	1152 LM	>90	5 M	10	ID/03546768	€ 158,00
			BOUCHERIE	1152 LM	>90	5 M	10	ID/03546769	€ 158,00
			CHARCUTERIE	1152 LM	>91	5 M	10	ID/03546770	€ 158,00



STRIPS LED



STRIPS LED



Minimaliste, cette nouvelle gamme Led ultra fine est très esthétique et pure. Sa très grande flexibilité et ses possibilités de torsion incroyables permettent toutes les configurations courbes possibles. Les tronçons de led étant très rapprochés, aucun trou de lumière ne se forme. Une lumière tamisée s'étire ainsi sur toute la longueur, sans aucun point lumineux. Notez que ce produit est IP 67, idéal pour des traçages courbes en extérieur comme en intérieur. En bobine de 10 mètres, (fournie avec ses 20 clips de fixation, 5 embouts de finition, 5 embouts d'étanchéité côté alimentation, 2 mini-tubes de silicone), ou également à la demande pour le sur-mesure. Avec la bobine de 5m, les accessoires sont en option.

LAZER THIN

LED

5
ANS

IP67

120°

IRC
>80A++
A

24V

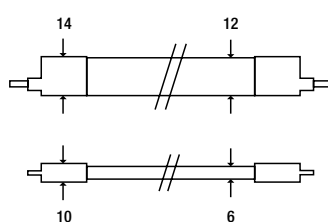

Accessoires inclus avec la bobine de 10m:

- 20 clips de fixation
- 5 embouts de finition
- 5 embouts d'étanchéité côté alimentation
- 2 mini-tubes de silicone

Avec la bobine de 5m :

- Accessoires en option voir p. 17
- Convertisseur voir p. 444 - 445

PUISSANCE / M	✂ SÉCABILITÉ	T°	FLUX / M	LONGUEUR	RÉF. ID	PRIX HTVA
14,4 W	50 MM	3000°K	360 LM	5 M	ID/03128888	€ 260,00
				10 M	ID/02736883	€ 517,00
		4000°K	432 LM	5 M	ID/03128889	€ 260,00
				10 M	ID/02736884	€ 517,00

LAZER

LED

5
ANS

IP67

120°

IRC
>80A++
A

24V

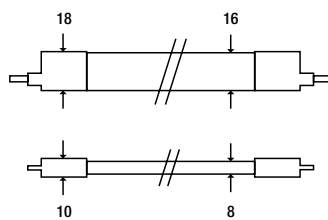

Accessoires inclus avec la bobine de 10m:

- 20 clips de fixation
- 5 embouts de finition
- 5 embouts d'étanchéité côté alimentation
- 2 mini-tubes de silicone

Avec la bobine de 5m :

- Accessoires en option voir p. 17
- Convertisseur voir p. 444 - 445

PUISSANCE / M	✂ SÉCABILITÉ	T°	FLUX / M	LONGUEUR	RÉF. ID	PRIX HTVA
14,4 W	50 MM	3000°K	504 LM	5 M	ID/03128890	€ 275,00
				10 M	ID/02736885	€ 543,00
		4000°K	576 LM	5 M	ID/03128891	€ 275,00
				10 M	ID/02736886	€ 543,00

LAZER DEMI ROND

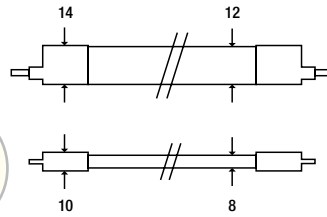

Accessoires inclus avec la bobine de 10m:
 - 20 clips de fixation
 - 5 embouts de finition
 - 5 embouts d'étanchéité côté alimentation
 - 2 mini-tubes de silicone
 Avec la bobine de 5m :
 Accessoires en option voir ci-dessous
 - Convertisseur voir p. 444 - 445

PUISSANCE	SÉCABILITÉ	T°	FLUX /M	LONGUEUR	RÉF. ID	PRIX HTVA
14,4 W/M	25 MM	3000°K	1008 LM	5 M	ID/03128892	€ 205,00
				10 M	ID/02736887	€ 401,00
		4000°K	1296 LM	5 M	ID/03128893	€ 205,00
				10 M	ID/02736888	€ 401,00

LAZER RGB

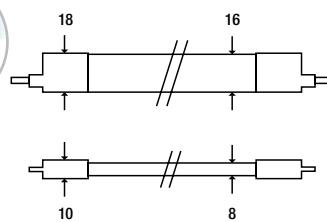
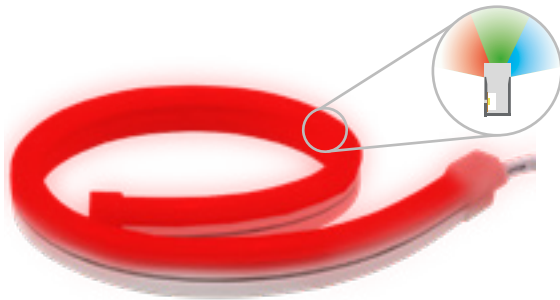

Accessoires inclus avec la bobine de 10m:
 - 20 clips de fixation
 - 5 embouts de finition
 - 5 embouts d'étanchéité côté alimentation
 - 2 mini-tubes de silicone
 Avec la bobine de 5m :
 - Accessoires en option voir ci-dessous
 - Convertisseur voir p. 444 - 445
 - Contrôleurs voir p. 30 - 36

PUISSANCE	SÉCABILITÉ	FLUX /M	T°	LONGUEUR	RÉF. ID	PRIX HTVA
14,4W/M	100 MM	200 LM	RGB	5 M	ID/03128895	€ 295,00
				10 M	ID/02797984	€ 580,00

RÉF. ID	ACCESSOIRES LAZER	PRIX HTVA
ID/02846135	KIT 20 CLIPS + 5 ALIM + 5 EMBOUTS DE FINITION + 2 MINI-TUBES DE SILICONE - LAZER THIN	€ 49,00
ID/02846136	KIT 20 CLIPS + 5 ALIM + 5 EMBOUTS DE FINITION + 2 MINI-TUBES DE SILICONE - LAZER	€ 50,00
ID/03128896	KIT 20 CLIPS + 5 ALIM + 5 EMBOUTS DE FINITION + 2 MINI-TUBES DE SILICONE - LAZER RGB	€ 40,00
ID/02846137	KIT 20 CLIPS + 5 ALIM + 5 EMBOUTS DE FINITION + 2 MINI-TUBES DE SILICONE - LAZER DEMI ROND	€ 35,00
ID/02846138	PROFIL ALU 2M POUR LAZER THIN	€ 34,00
ID/02846139	PROFIL ALU 2M POUR LAZER	€ 38,00
ID/03128894	PROFIL ALU 2M POUR LAZER RGB	€ 40,00



CRÉEZ VOTRE PROPRE CONFIGURATION

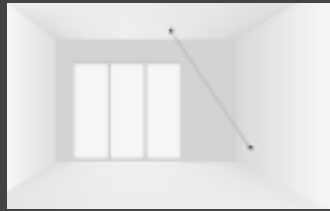
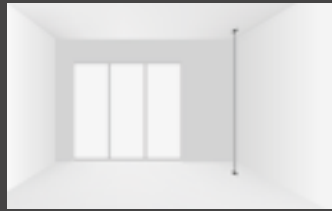

LIANA

5 ANS

IP20



Système d'éclairage LIANA : esthétique par son minimalisme !

Il se compose d'une bande d'acier associée à un support mural et d'une bande LED alimentée par un Driver 24 V. Il est idéal pour de nombreuses applications pour de l'éclairage direct, indirect ou Wall Washer.

Vous tendez simplement la lame métallique entre deux murs, attachez et collez la bande LED de votre choix et un éclairage vers le haut, vers le bas ou en lumière rasante est né. Installation facile. Pas besoin de préparations intérieures compliquées. Il n'est pas nécessaire que les murs soient droits ou lisses.

La lame métallique peut être ajustée à n'importe quelle longueur, avec un ajustement de la longueur de bande LED en conséquence (la limite de longueur maximale doit être respectée : 5 ou 10 mètres maxi selon références).



VIDÉO DE MONTAGE

UTILISEZ LES RUBANS COB (VOIR PAGE 6) POUR UN RÉSULTAT OPTIMAL



COMPOSEZ VOTRE LIANA

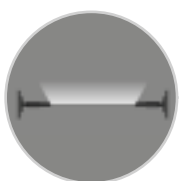

SET DE TENDEURS LIANA



RUBAN COB
VOIR PAGE 6

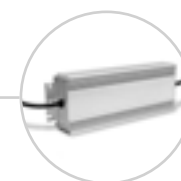

ALIMENTATION
VOIR PAGE 444 - 445

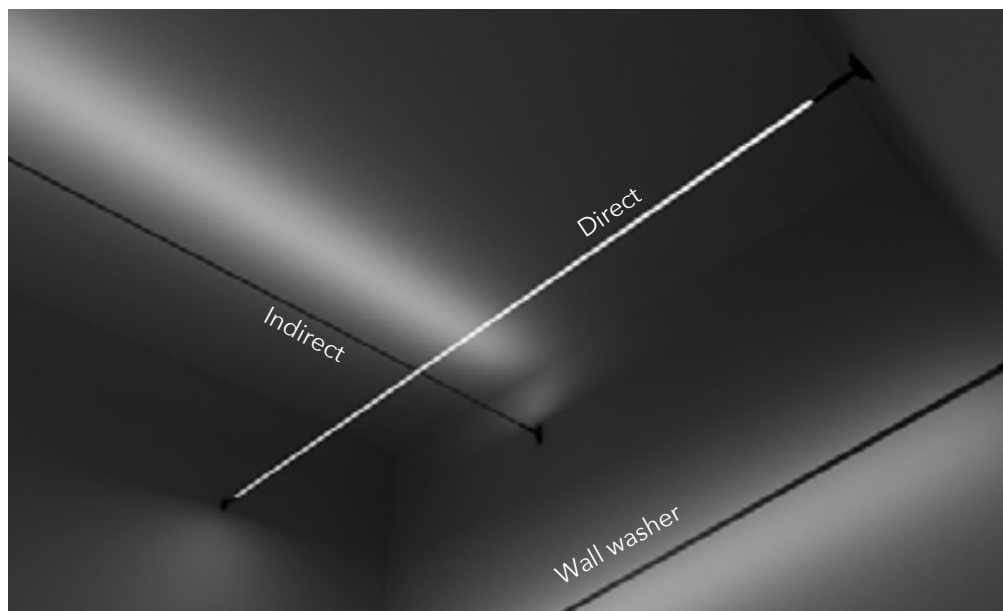
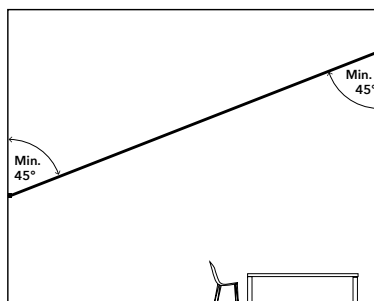
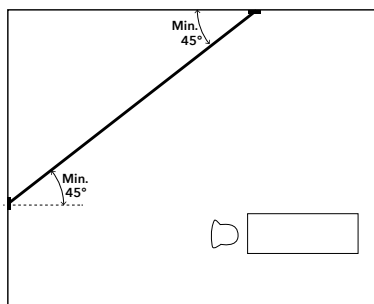

NEW

RÉF. ID	LONGUEUR	COULEUR	PRIX HTVA
ID/03546912	5 M	● NOIR	€ 230,00
ID/03546913	10 M	● NOIR	€ 280,00

PROFILES ALUMINIUM



DIDO

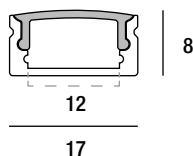

Profil aluminium anodisé. Conçu pour intégrer des Rubans LED simple bande. Inclus : 4 clips de fixation, 2 embouts et 1 diffuseur dépoli.

COMPATIBLE AVEC :
VOIR TABLEAU PAGE 28

NEW

RÉF. ID	LONGUEUR	COULEUR	PLEXI	PRIX HTVA
ID/03546740	2 M	● ALU	OPALIN	€ 19,00
ID/02554231	2 M	○ BLANC	OPALIN	€ 24,00
ID/03546742	2 M	● NOIR	OPALIN	€ 24,00
ID/03546743	2 M	● NOIR	NOIR	€ 24,00



LEO

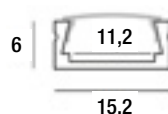

Profil aluminium anodisé. Conçu pour intégrer des Rubans LED simple bande. Inclus : 4 clips de fixation, 2 embouts et 1 diffuseur dépoli.

COMPATIBLE AVEC :
VOIR TABLEAU PAGE 28

NEW

RÉF. ID	LONGUEUR	COULEUR	PLEXI	PRIX HTVA
ID/02204636	2 M	○ BLANC	OPALIN	€ 23,00
ID/02204638	2 M	● NOIR	OPALIN	€ 23,00
ID/03383186	2 M	● NOIR	NOIR	€ 23,00



DOMAS

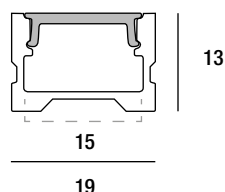

Profil aluminium anodisé. Conçu pour intégrer des Rubans LED simple bande. Inclus : 4 clips de fixation, 2 embouts et 1 diffuseur dépoli.

COMPATIBLE AVEC :
VOIR TABLEAU PAGE 28

NEW

RÉF. ID	LONGUEUR	COULEUR	PLEXI	PRIX HTVA
ID/02792008	2 M	● ALU	OPALIN	€ 23,00

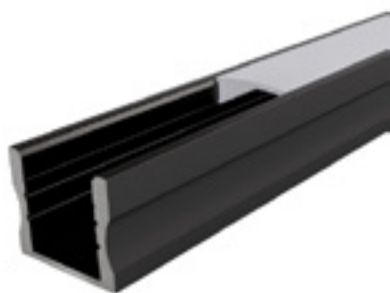

DAN

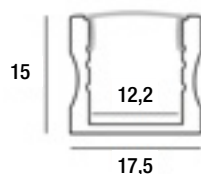

Profil aluminium anodisé. Conçu pour intégrer des Rubans LED simple bande. Inclus : 4 clips de fixation, 2 embouts et 1 diffuseur dépoli.

COMPATIBLE AVEC :
VOIR TABLEAU PAGE 28

NEW

RÉF. ID	LONGUEUR	COULEUR	PLEXI	PRIX HTVA
ID/02204635	2 M	○ BLANC	OPALIN	€ 31,00
ID/02204637	2 M	● NOIR	OPALIN	€ 31,00
ID/03383185	2 M	● NOIR	NOIR	€ 31,00

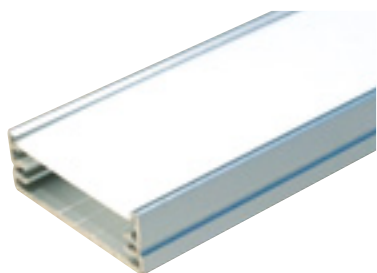

PRAVE

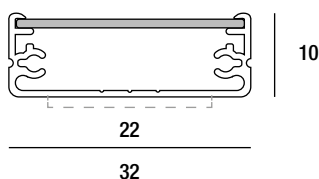

Profil en aluminium anodisé. Conçu pour intégrer des Rubans LED double bande. Version à poser. Diffuseur dépoli inclus.

COMPATIBLE AVEC :
VOIR TABLEAU PAGE 28

NEW

RÉF. ID	LONGUEUR	COULEUR	PLEXI	PRIX HTVA
ID/02554225	2 M	● ALU	OPALIN	€ 50,00
ID/02554229		CLIPS DE FIXATIONS		€ 2,50
ID/02554230		EMBOUT DE FINITION 1 PCS		€ 5,00

NEW



Les schémas techniques des profiles sont à taille réelle
Présentez votre strip led sur le schéma pour vérifier sa compatibilité

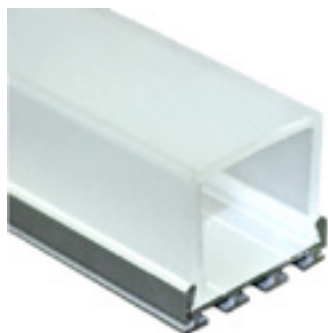

VERLI

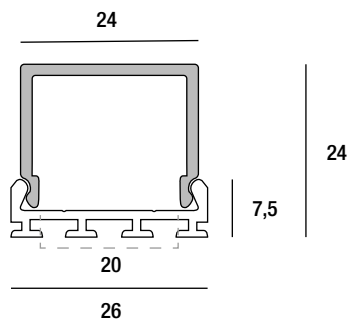









Profil en aluminium anodisé. Conçu pour intégrer des Rubans LED simple ou double bande.
A poser ou à suspendre
Diffuseur dépoli inclus

COMPATIBLE AVEC :
VOIR TABLEAU PAGE 28

NEW

RÉF. ID	LONGUEUR	COULEUR	PLEXI	PRIX HTVA
ID/01554717	1 M	● ALU	OPALIN	€ 53,00
ID/01554718	2 M	● ALU	OPALIN	€ 107,00

ACCESSOIRES VERLI

RÉF. ID	ACCESSOIRES	PRIX HTVA
ID/01554726	 CLIP DE FIXATION POUR PROFIL 4306	€ 2,00
ID/02846121	 CONNEXION 90° PROFIL 4306	€ 7,60
ID/02846122	 CONNEXION 120° PROFIL 4306	€ 7,60
ID/02846123	 CONNEXION 135° PROFIL 4306	€ 7,60
ID/02846124	 CONNEXION 180° PROFIL 4306	€ 7,60
ID/03546724	 CONNEXION 135° MONTANT PROFIL 4306	€ 7,60
ID/03546723	 CONNEXION 90° MONTANT PROFIL 4306	€ 7,60
ID/01554729	 EMBOUT DE FINITION POUR PROFIL 4306	€ 4,00
ID/02554224	 SUSPENSION POUR PROFIL 4306	€ 8,30

NEW



Les schémas techniques des profiles sont à taille réelle
Présentez votre strip led sur le schéma pour vérifier sa compatibilité



ARAGO

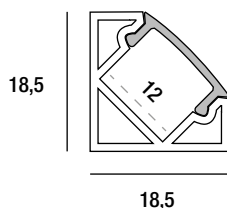

Profil aluminium anodisé. Conçu pour intégrer des Rubans LED simple bande. Inclus : 4 clips de fixation, 2 embouts et 1 diffuseur dépoli.

COMPATIBLE AVEC :
VOIR TABLEAU PAGE 28

NEW

RÉF. ID	LONGUEUR	COULEUR	PLEXI	PRIX HTVA
ID/03546744	2 M	● ALU	OPALIN	€ 24,00
ID/03546746	2 M	○ BLANC	OPALIN	€ 34,00
ID/03546745	2 M	● NOIR	OPALIN	€ 34,00
ID/03546747	2 M	● NOIR	NOIR	€ 36,00



PLATA

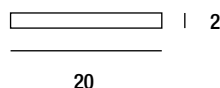

Profil aluminium sans diffuseur. Conçu pour assurer la dissipation thermique des Rubans LED simple bande ou double bande maxi 20 mm. Lame métallique 2000 x 20 x 2 mm.

COMPATIBLE AVEC :
VOIR TABLEAU PAGE 28

NEW

RÉF. ID	LONGUEUR	COULEUR	PRIX HTVA
ID/03546711	2 M	● ALU	€ 10,50

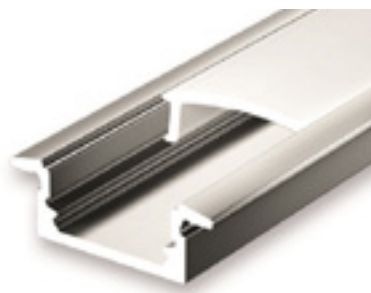

VALERA

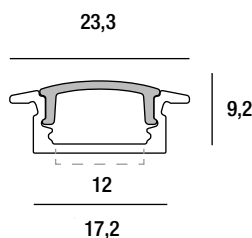

Profil aluminium anodisé. Conçu pour intégrer des Rubans LED simple bande. Inclus : 1 diffuseur dépoli.

COMPATIBLE AVEC :
VOIR TABLEAU PAGE 28

NEW

RÉF. ID	LONGUEUR	COULEUR	PLEXI	PRIX HTVA
ID/02554227	2 M	● ALU	OPALIN	€ 21,00

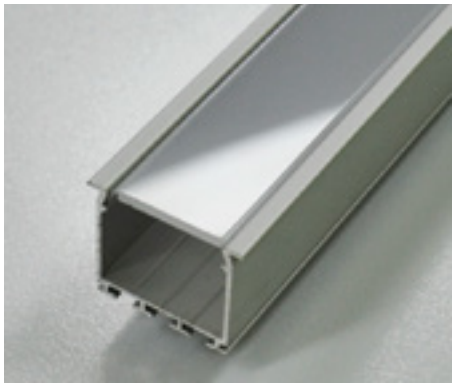

GIANA

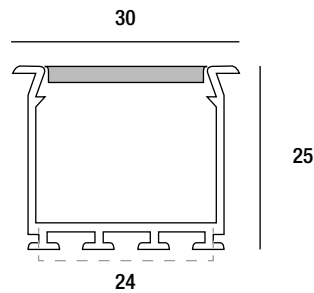

Profil en aluminium anodisé, finition blanc, noir ou alu à bords fins pour intégrer des rubans LED simple ou double bande.

COMPATIBLE AVEC :
VOIR TABLEAU PAGE 28

NEW

RÉF. ID	LONGUEUR	COULEUR	PLEXI	PRIX HTVA
ID/01554722	2 M	● ALU	OPALIN	€ 93,00
ID/03546729	2 M	○ BLANC	OPALIN	€ 93,00
ID/03582944	2 M	● NOIR	OPALIN	€ 93,00
ID/01554731		EMBOUT DE FINITION ALU		€ 4,00
ID/03546734		EMBOUT DE FINITION BLANC		€ 3,50
ID/02761074		EMBOUT DE FINITION NOIR		€ 3,50
ID/01554724		PROFIL D'ENCASTREMENT 2M		€ 52,00
ID/01554727		RESSORT DE FIXATION (PRÉVOIR 2 PIÈCES TOUTS LES 50 CM)		€ 1,30



GIANA L

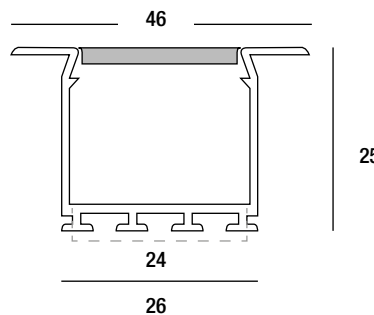

Profil en aluminium anodisé, finition blanc, noir ou alu à bords larges pour intégrer des rubans LED simple ou double bande.

COMPATIBLE AVEC :
VOIR TABLEAU PAGE 28

NEW

RÉF. ID	LONGUEUR	COULEUR	PLEXI	PRIX HTVA
ID/03546712	2 M	● ALU	OPALIN	€ 93,00
ID/03546730	2 M	○ BLANC	OPALIN	€ 93,00
ID/03582945	2 M	● NOIR	OPALIN	€ 93,00
ID/03546725		EMBOUT DE FINITION ALU		€ 3,50
ID/03546733		EMBOUT DE FINITION BLANC		€ 3,50
ID/02761073		EMBOUT DE FINITION NOIR		€ 3,50
ID/03234010		RESSORT DE FIXATION (PRÉVOIR 2 PIÈCES TOUTSLES 50 CM)		€ 1,80

NEW

ÉCHELLE
1:1

Les schémas techniques des profiles sont à taille réelle

Présentez votre strip led sur le schéma pour vérifier sa compatibilité

PROFIL BLACK EDITION PREMIUM

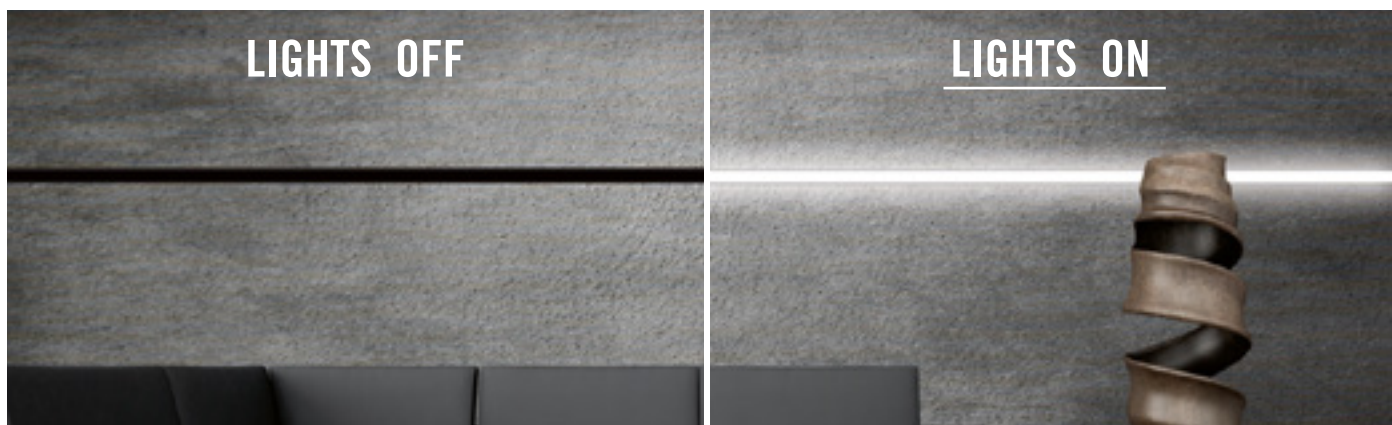

LES COVERS NOIRS CRÉENT UN RÉSULTAT UNIQUE ET FASCINANT.

Profils Black Edition conçus pour des utilisations décoratives élégantes.

Il est muni d'un diffuseur noir, discret et esthétique. Allumé, il diffuse une bande lumineuse douce.

Éteint, il reste noir invisible.

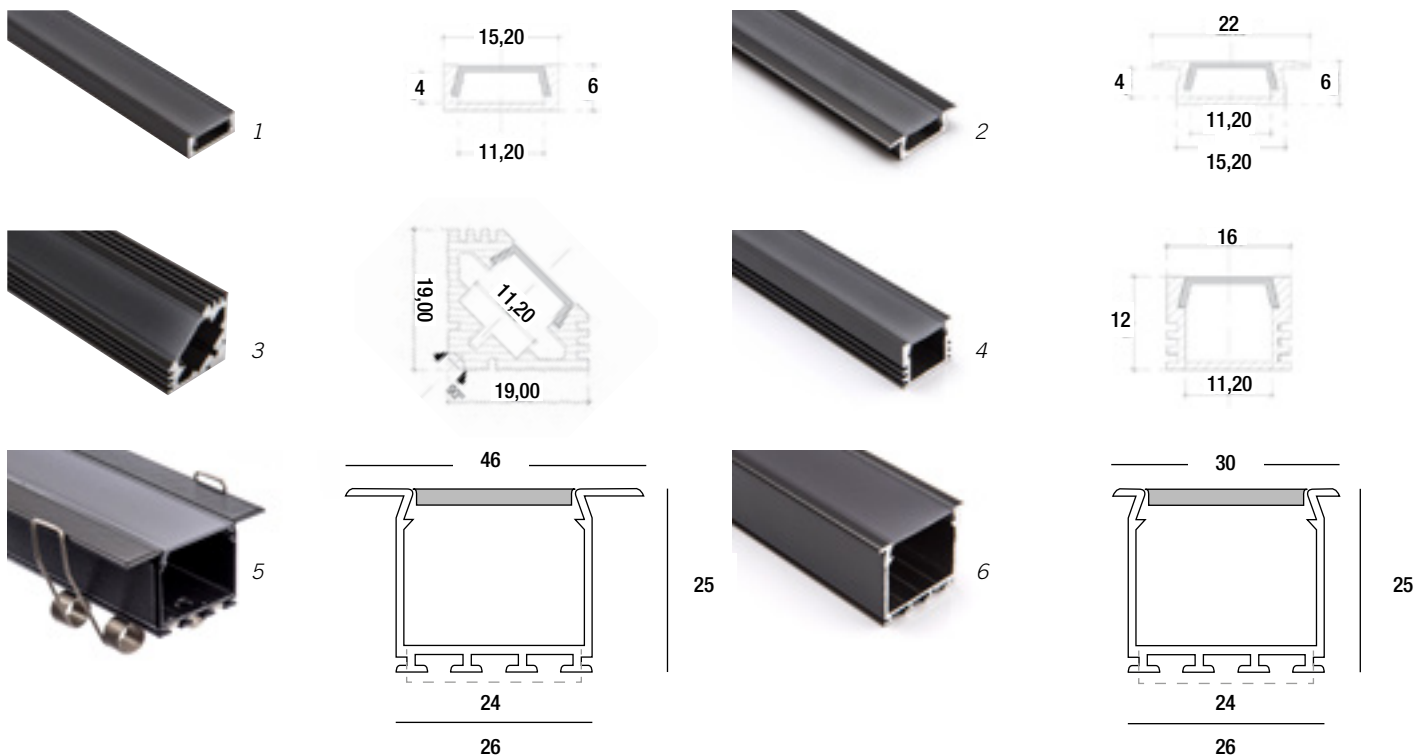

N°	RÉF. ID	TYPE	LONGUEUR	COULEUR	PRIX HTVA
1	ID/02761060	MINI	2 M	● NOIR	€ 53,00
2	ID/02761061	ENCASTRE S	2 M	● NOIR	€ 57,00
3	ID/02761062	ANGLE	2 M	● NOIR	€ 70,00
4	ID/02761063	STANDARD	2 M	● NOIR	€ 61,00
5	ID/02761064	ENCASTRE LARGE +	2 M	● NOIR	€ 101,00
6	ID/02761065	ENCASTRE LARGE	2 M	● NOIR	€ 93,00

ACCESSOIRES BLACK EDITION PREMIUM

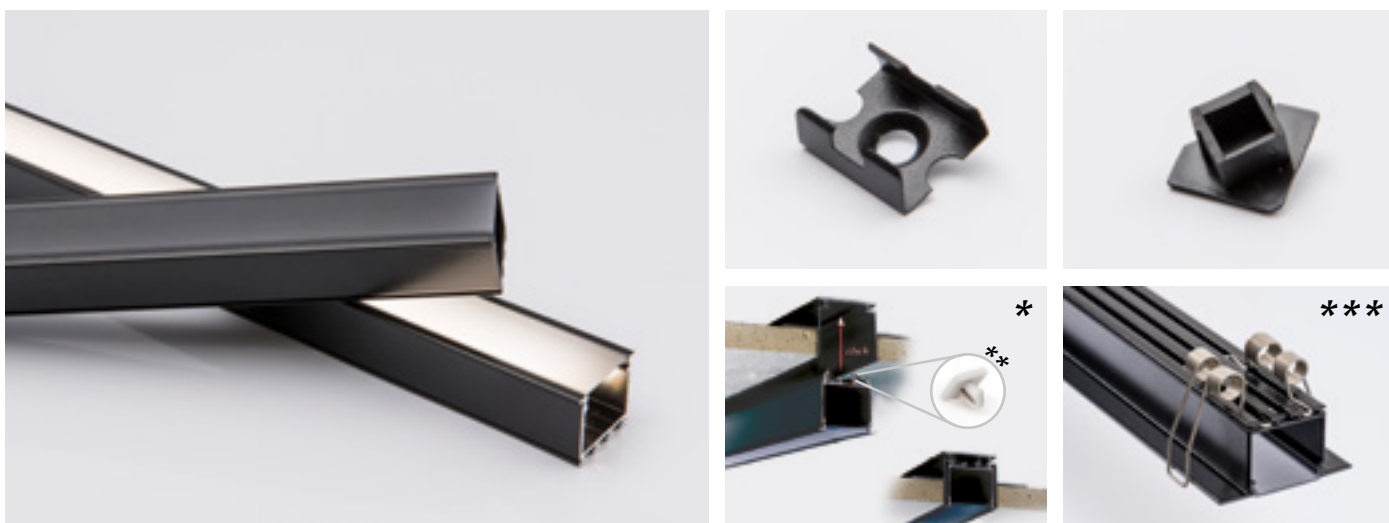

RÉF. ID	ACCESSOIRES	PRIX HTVA
ID/02761066	FIXATION POUR PROFIL N°1 - 1 PIÈCE	€ 3,50
ID/02761067	FIXATION POUR PROFIL N°3 - 1 PIÈCE	€ 3,50
ID/02761069	EMBOUT DE FINITION POUR PROFIL N°1 - 1 PIÈCE	€ 3,50
ID/02761070	EMBOUT DE FINITION POUR PROFIL N°2 - 1 PIÈCE	€ 3,50
ID/02761071	EMBOUT DE FINITION POUR PROFIL N°3 - 1 PIÈCE	€ 3,50
ID/02761072	EMBOUT DE FINITION POUR PROFIL N°4 - 1 PIÈCE	€ 3,50
ID/02761073	EMBOUT DE FINITION POUR PROFIL N°5 - 1 PIÈCE	€ 3,50
ID/03234010	FIXATION PAR RESSORTS POUR PROFIL N°5 *** - 1 PIÈCE	€ 1,80
ID/02761074	EMBOUT DE FINITION POUR PROFIL N°6 - 1 PIÈCE	€ 3,50
ID/01554724	PROFIL D'ENCASTREMENT 2M POUR PROFIL N°6 *	€ 52,00
ID/01554727	CLIP DE FIXATION POUR PROFIL N°6 ** - 1 PIÈCE	€ 1,30

NEW



Les schémas techniques des profiles sont à taille réelle

Présentez votre strip led sur le schéma pour vérifier sa compatibilité

COMPATIBILITÉS DES STRIPS LED ET DES PROFILES

	COB		2216						2835					ARCHI BICOLOR		ARCHI RGB		RGB+ BLANC	RGB+ CCT	FOOD	PAGE
	IP20	15W	IP20			IP66			IP20		IP66		IP67	IP65		IP65		IP65	IP65	IP67	
			4,8W	9,6W	19,2W	4,8W	9,6W	19,2W	14,4W	28,8W	14,4W	26,4W	28,8W	13W	26W	14,4W	28,8W	17,3W	24W	14,4W	
DIDO	✓	✓	✓	✓	✓	✓	✓	✓	✓	✓	✓	✓	✓	✓	✓	✓	✓	✓	✓	20	
LEO	✓	✓	✓	✓	✓	✓	✓	✓	✓	✓	✓	✓	✓	✓	✓	✓	✓	✓	✓	20	
DOMAS	✓	✓	✓	✓	✓	✓	✓	✓	✓	✓	✓	✓	✓	✓	✓	✓	✓	✓	✓	20	
DAN	✓	✓	✓	✓	✓	✓	✓	✓	✓	✓	✓	✓	✓	✓	✓	✓	✓	✓	✓	21	
PRAVE	✓	✓	✓	✓	✓	✓	✓	✓	✓	✓	✓	✓	✓	✓	✓	✓	✓	✓	✓	21	
VERLI	✓	✓	✓	✓	✓	✓	✓	✓	✓	✓	✓	✓	✓	✓	✓	✓	✓	✓	✓	22	
ARAGO	✓	✓	✓	✓	✓	✓	✓	✓	✓	✓	✓	✓	✓	✓	✓	✓	✓	✓	✓	23	
PLATA	✓	✓	✓	✓	✓	✓	✓	✓	✓	✓	✓	✓	✓	✓	✓	✓	✓	✓	✓	23	
VALERA	✓	✓	✓	✓	✓	✓	✓	✓	✓	✓	✓	✓	✓	✓	✓	✓	✓	✓	✓	23	
GIANA (L)	✓	✓	✓	✓	✓	✓	✓	✓	✓	✓	✓	✓	✓	✓	✓	✓	✓	✓	✓	24	
BLACK MINI	✓	✓	✓	✓	✓	✓	✓	✓	✓	✓	✓	✓	✓	✓	✓	✓	✓	✓	✓	26	
BLACK ENCASTRÉ	✓	✓	✓	✓	✓	✓	✓	✓	✓	✓	✓	✓	✓	✓	✓	✓	✓	✓	✓	26	
BLACK ANGLE	✓	✓	✓	✓	✓	✓	✓	✓	✓	✓	✓	✓	✓	✓	✓	✓	✓	✓	✓	26	
BLACK STANDARD	✓	✓	✓	✓	✓	✓	✓	✓	✓	✓	✓	✓	✓	✓	✓	✓	✓	✓	✓	26	
BLACK ENCASTRÉ LARGE (+)	✓	✓	✓	✓	✓	✓	✓	✓	✓	✓	✓	✓	✓	✓	✓	✓	✓	✓	✓	26	



MINI DÉTECTEUR ET INTERRUPTEUR RUBANS LED

3
ANS



- Se place dans les profils de + de 10mm

RÉF. ID	TYPE	ENTRÉE	SORTIE	PRIX HTVA
ID/01736043	DÉTECTEUR DE PRÉSENCE À INTÉGRER DANS UN PROFILÉ DÉTECTION: ±1M - TEMPORISATION: 40S.	24VDC	24VDC	€ 16,00
ID/02204678	INTERRUPTEUR ON/OFF INVISIBLE À INTÉGRER DANS UN PROFILÉ	24VDC	24VDC	€ 16,00



SET DE CONTRÔLE MONOCHROME

5 ANS IP20



- Kit: émetteur (télécommande) + récepteur
- OUT : 180W en DC 12 V (3CH X 5A)
- OUT : 360W en DC 24 V (3CH X 5A)
- Fréquence d'émission 868 MHz
- Portée de la télécommande ±30m
- 4 zones possibles
- 2 enregistrements possibles par zone
- Dimming

RÉF. ID	PRIX HTVA
ID/02122199	€ 83,00

SET DE CONTRÔLE BLANC CHAUD - BLANC FROID

5 ANS IP20



- Kit: émetteur (télécommande) + récepteur
- OUT : 180W en DC 12 V (3CH X 5A)
- OUT : 360W en DC 24 V (3CH X 5A)
- Fréquence d'émission 868 MHz
- Portée de la télécommande ±30m
- 4 zones possibles
- 2 enregistrements possibles par zone
- Dimming

RÉF. ID	PRIX HTVA
ID/02122197	€ 83,00

SET DE CONTRÔLE RGB

5 ANS IP20



- Kit: émetteur (télécommande) + récepteur
- OUT : 180W en DC 12 V (3CH X 5A)
- OUT : 360W en DC 24 V (3CH X 5A)
- Fréquence d'émission 868 MHz
- Portée de la télécommande ±30m
- 1 zone possible
- 10 scénarios pré-programmés
- Dimming
- Pré-sélection blanc chaud, neutre et froid

RÉF. ID	PRIX HTVA
ID/02122196	€ 83,00

SET DE CONTRÔLE RGBW

5 ANS IP20



- Kit: émetteur (télécommande) + récepteur
- OUT : 240W en DC 12 V (4CH X 5A)
- OUT : 480W en DC 24 V (4CH X 5A)
- Fréquence d'émission 868 MHz
- Portée de la télécommande ±30m
- Récepteur: 46 x 145 x 16 mm
- Présélection blanc chaud, neutre et froid
- 10 scénarios pré-programmés

RÉF. ID	PRIX HTVA
ID/02122198	€ 88,00

CONTRÔLEURS BLUETOOTH

RÉCEPTEUR BLUETOOTH 4 EN 1



12V
24V



- Contrôleur LED universel RF + Bluetooth 4 en 1
- 4 modes : DIM, CCT, RGBW et RGB + CCT dans 1 seul contrôleur
- Contrôlé à la fois via une application intelligente gratuite (EASYTHINGS) et par une télécommande, aucune passerelle requise
- Couplage facile et rapide à l'application intelligente en scannant le code QR sur le côté du Driver
- Réseau maillé
- Jusqu'à 30 m de distance de transmission entre deux appareils voisins
- Transmission de données sûre et fiable
- Compatible avec les télécommandes universelles RF + Bluetooth (voir ci-dessous), chaque contrôleur LED peut être couplé à max. 8 télécommandes

NEW

RÉF. ID	DESCRIPTION	PUISSANCE MAX	ENTRÉE	SORTIE	DIMENSIONS MM	PRIX HTVA
ID/03546957	BLUETOOTH RECEPTEUR 4 EN 1	384 - 768W	12 - 24V	4 X 8 A	170 X 59 X 29	€ 88,00

TÉLÉCOMMANDE CONTRÔLEUR BLUETOOTH



- Commande ON/OFF et réglage de la luminosité (DIM)
- Batterie : 3 VDC (CR2025 inclus)
- Contrôleur mono couleur
- 4 zones
- 2 scènes

NEW

RÉF. ID	DESCRIPTION	FRÉQUENCE	PRIX HTVA
ID/03546958	BLUETOOTH COMMANDE DIM 4 ZONES	2,4 GHZ	€ 61,00

TÉLÉCOMMANDE CONTROLEUR RGB + CCT



- Contrôlez 3 zones en RF + Bluetooth. Les canaux RGB et les canaux CCT sont contrôlés séparément
- Couplage facile et rapide aux récepteurs RF + Bluetooth
- Réseau maillé
- Les récepteurs peuvent se transmettre un signal Bluetooth à faible consommation d'énergie
- Batterie : 2 x 1,5 VDC (AAA non inclus)

NEW

RÉF. ID	DESCRIPTION	FRÉQUENCE	PRIX HTVA
ID/03546956	BLUETOOTH COMMANDE RGB+CCT 3 ZONES	2,4 GHZ	€ 74,00

EASYTHINGS APPLICATION BLUETOOTH

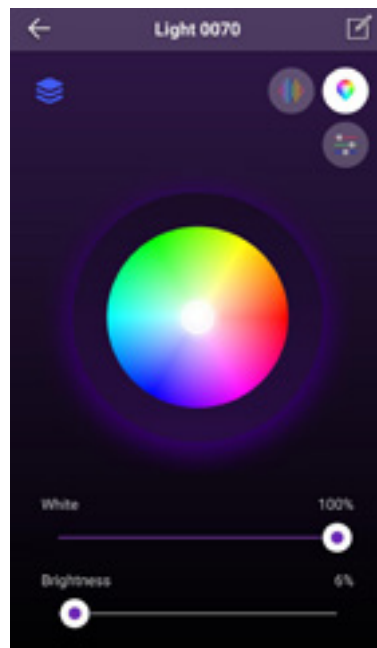
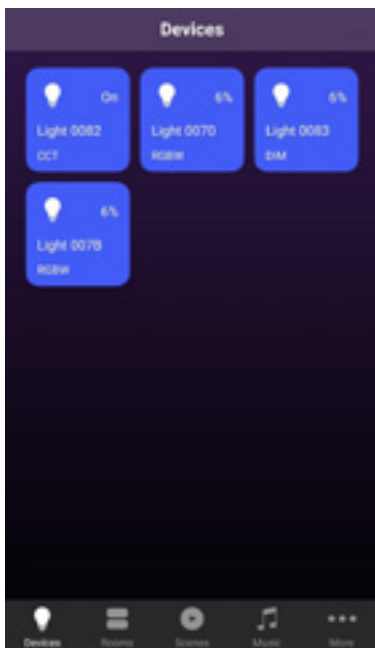

- Variation RGB, température de couleur, luminosité, on/off
- Création de groupes de luminaires
- Création de scènes
- Programmation des allumages

EASYTHINGS

Application téléchargeable sur :

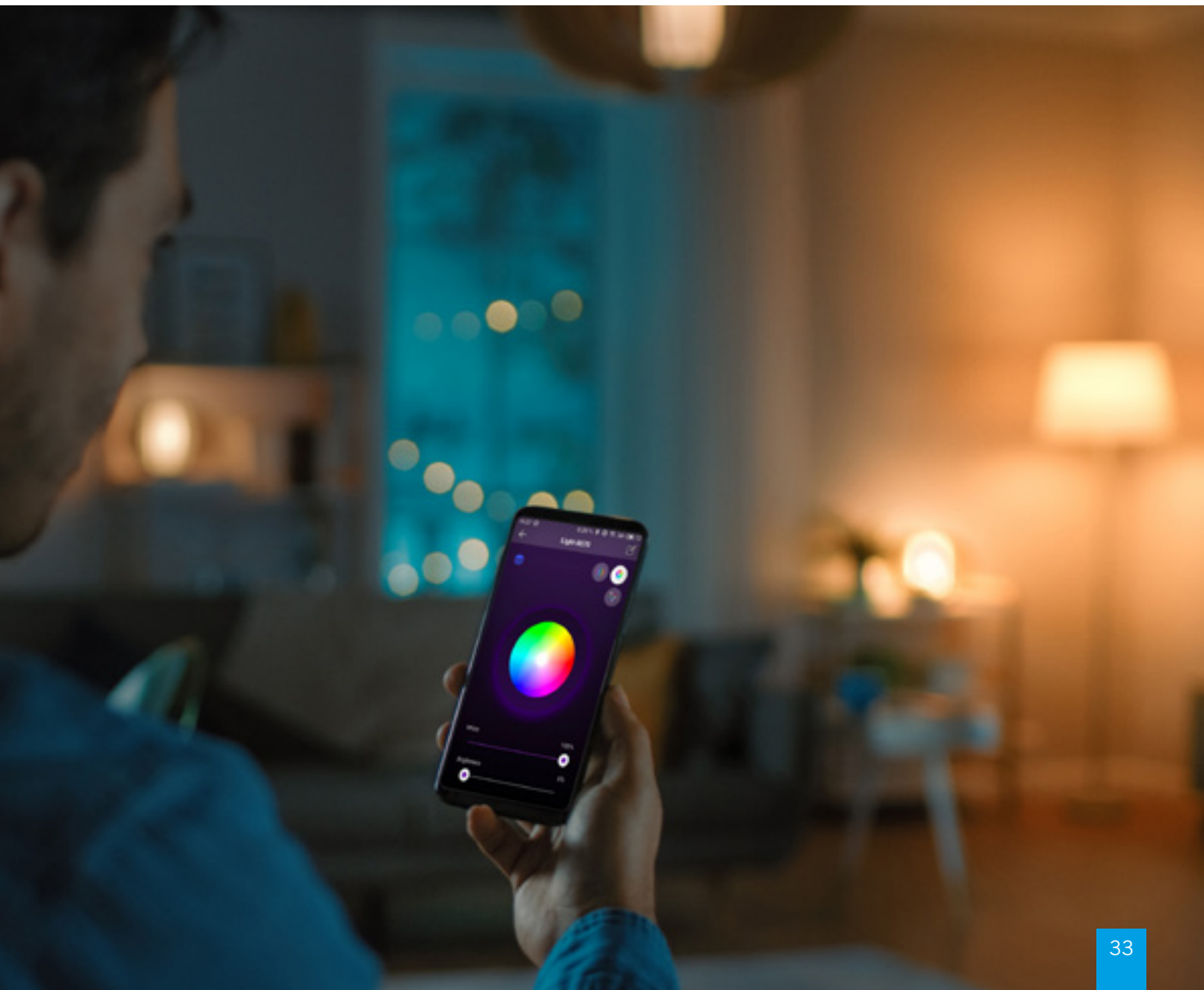
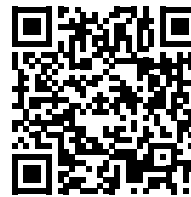

CONTRÔLEURS ZIGBEE

Zigbee 3.0 est un protocole de communication sans fil de haut niveau. Zigbee, permet le pilotage à distance d'équipements domestiques, équipés de petits émetteurs radios à faible consommation. À partir d'une télécommande, d'un smartphone, d'une tablette ou d'un assistant vocal intelligent, il devient très facile de configurer et de gérer sans câblage ni accessoires supplémentaires, un système d'éclairage dans sa totalité et par zones. L'application reconnaît automatiquement et associe les appareils. Cette solution de contrôle de l'éclairage à distance peut s'interfacer avec les protocoles de contrôle DALI ou 1-10 V et permet de gérer les sources de lumières individuellement et groupées afin de créer des scénarios utilisateurs personnalisés.

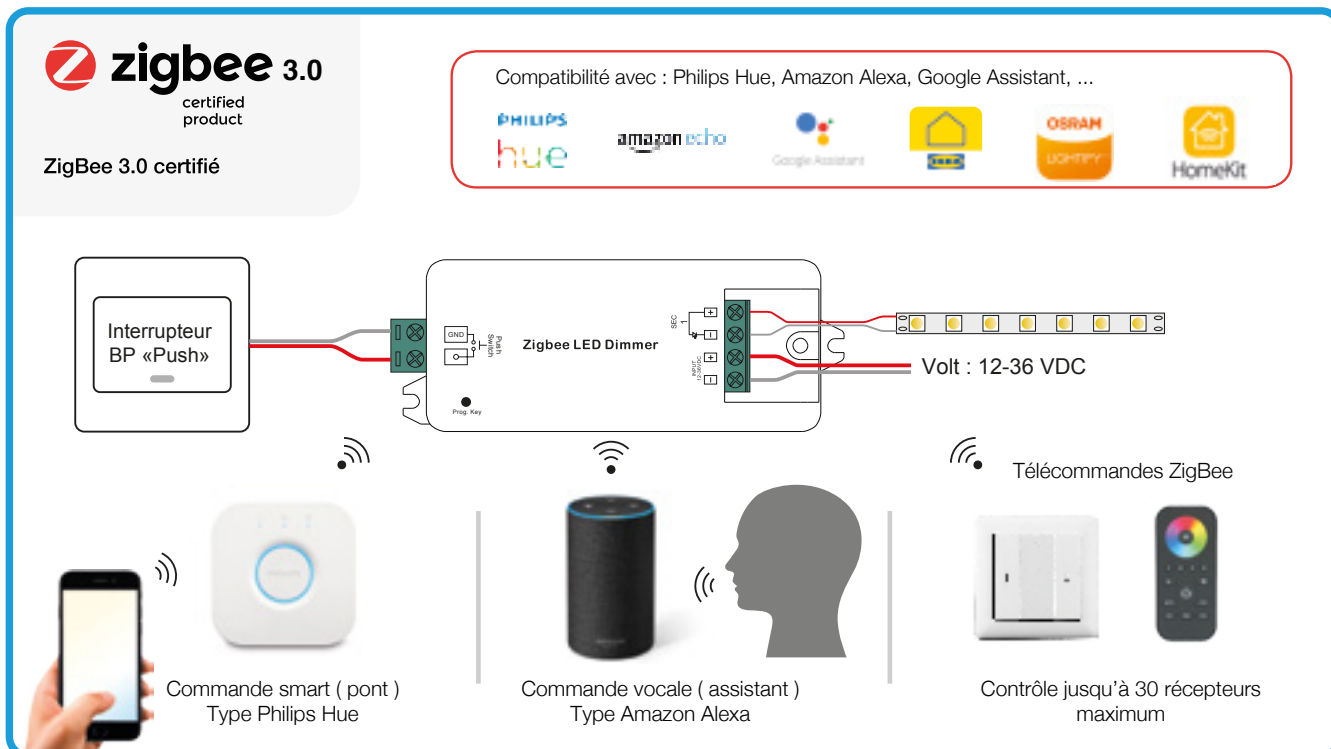

TÉLÉCOMMANDE MONO ZIGBEE

5 ANS IP20



- Commande ON/OFF et réglage de la luminosité (DIM)
- Batterie : 3 VDC (CR2025 inclus)
- Contrôleur mono couleur
- 4 zones
- 2 scènes

RÉF. ID	FRÉQUENCE	PRIX HTVA
ID/03129054	2,4GHZ	€ 43,00

TÉLÉCOMMANDE ZIGBEE

5 ANS IP20



- Commande ON/OFF et réglage de RGBW/RGB/CCT/Mono
- Batterie : 3 x 1,5 VDC (AAA non inclus)
- 4 zones de maximum 30 récepteurs
- Mode de recherche et de liaison pour associer avec un récepteur ZigBee
- Possibilité de mémoriser 3 scènes

RÉF. ID	FRÉQUENCE	TYPE	PRIX HTVA
ID/03129053	2,4GHZ	RGB OU RGB + BLANC	€ 83,00
ID/03129051	2,4GHZ	BLANC CHAUD + BLANC FROID	€ 83,00
ID/03129052	2,4GHZ	DIMMING MONOCHROME	€ 83,00

CONTRÔLEUR MURAL ZIGBEE

5
ANS

IP20



- Commande ON/OFF et réglage de la luminosité (DIM)
- Batterie : 3 VDC (CR2450 inclus).
- Contrôleur MONOCOULEUR, CCT, RGB et RGBW suivant modèle

RÉF. ID	FRÉQUENCE	TYPE	PRIX HTVA
ID/03129055	2,4GHZ	MONO 1 ZONE	€ 74,00
ID/03129057	2,4GHZ	MONO 2 ZONES	€ 74,00
ID/03129060	2,4GHZ	MONO 4 ZONES	€ 74,00
ID/03129056	2,4GHZ	CCT / DUAL 1 ZONE	€ 74,00
ID/03129059	2,4GHZ	RGBW 1 ZONE	€ 74,00

CONTRÔLEUR MURAL ZIGBEE

5
ANS

IP20

230V

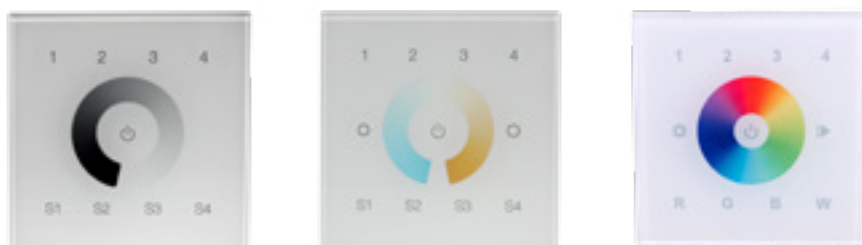

- Interrupteur en verre sensitif
- 4 zones
- Possibilité de mémoriser 4 scènes

RÉF. ID	FRÉQUENCE	TYPE	PRIX HTVA
ID/03129062	2,4GHZ	MONOCOULEUR	€ 96,00
ID/03129061	2,4GHZ	BLANC CHAUD BLANC FROID	€ 96,00
ID/03129063	2,4GHZ	RGB/RGB+W	€ 96,00

RÉCEPTEUR ZIGBEE 12-24V (1 X 8A)

5
ANS

IP20

12V
24V

- Comporte à la fois des fonctions de récepteur et de répéteur (maillage)
- Compatible avec tous les contrôleurs maîtres universels Zigbee
- Compatible avec bouton poussoir (push dim)
- Compatibilité avec :
Philips Hue, Amazon Alexa, Google Assistant pour gérer la lumière à distance sans fil

RÉF. ID	PUISSANCE MAX	ENTRÉE	SORTIE	DIMENSIONS MM	PRIX HTVA
ID/03129064	96W 12VDC 192W 24VDC	12-24V	1 X 8A	95 X 37 X 20	€ 53,00

RÉCEPTEUR ZIGBEE 12-24V (4 X 5A)

5
ANS

IP20

12V
24V

- Comporte à la fois des fonctions de récepteur et de répéteur (maillage)
- Compatible avec tous les contrôleurs maîtres universels Zigbee
- Compatibilité avec :
Philips Hue, Amazon Alexa, Google Assistant pour gérer la lumière à distance sans fil

RÉF. ID	PUISSANCE MAX	ENTRÉE	SORTIE	TYPE	DIMENSIONS MM	PRIX HTVA
ID/03129066	240W 12VDC 480W 24VDC	12-24V	4 X 5A	DIMMING MONOCHROME	170 X 53,4 X 28	€ 105,00
ID/03129065	240W 12VDC 480W 24VDC	12-24V	4 X 5A	BLANC CHAUD - BLANC FROID	170 X 53,4 X 28	€ 105,00
ID/03129067	240W 12VDC 480W 24VDC	12-24V	4 X 5A	RGB + BLANC	170 X 53,4 X 28	€ 105,00

RÉCEPTEUR/ALIMENTATION ZIGBEE DC24V

5
ANS

IP20

230V



- Compatible avec tous les bridges (hub) ZigBee 3.0
- Compatible avec télécommandes mono ZigBee 3.0

RÉF. ID	PUISSANCE MAX	ENTRÉE	SORTIE	VARIABLE	DIMENSIONS MM	PRIX HTVA
ID/03129070	50 W	230VAC	DC24V	OUI	210 X 50 X 32	€ 96,00
ID/03129071	100 W	230VAC	DC24V	OUI	210 X 50 X 32	€ 160,00

Récepteur Zigbee 230V page 455



MAGNETICA



Magnetica, un bandeau Led encapsulé dans une réglette aimantée compacte qui se fixe aisément sur tout support ferreux par magnétisme, ou par un simple système de clips de fixation.

Le raccordement invisible entre chaque réglette permet toutes formes d'agencements géométriques sans aucune zone sombre.

Un produit idéal pour les cuisines, les points de vente et sublimer les présentoirs.

À votre disposition, 5 tailles de réglettes de 15 cm à 120 cm. Chaque kit est fourni avec ses clips de fixation.

RÉF. ID	PUISSANCE	FLUX	T°	DIMENSIONS (MM)	PRIX HTVA
ID/02736891	3W	150 LM	3000°K	166 X 13 X 16	€ 22,00
ID/02736892	3W	210 LM	4000°K	166 X 13 X 16	€ 22,00
ID/02736893	6W	300 LM	3000°K	311 X 13 X 16	€ 30,00
ID/02736894	6W	420 LM	4000°K	311 X 13 X 16	€ 30,00
ID/02736895	12W	600 LM	3000°K	609 X 13 X 16	€ 45,00
ID/02736896	12W	840 LM	4000°K	609 X 13 X 16	€ 45,00
ID/02736897	18W	900 LM	3000°K	904 X 13 X 16	€ 60,00
ID/02736898	18W	1260 LM	4000°K	904 X 13 X 16	€ 60,00
ID/02736889	24W	1200 LM	3000°K	1199 X 13 X 16	€ 78,00
ID/02736890	24W	1680 LM	4000°K	1199 X 13 X 16	€ 78,00

RÉF. ID	ACCESSOIRES	PRIX HTVA
ID/02736899	CONNECTEUR D'ALIMENTATION 350 MM	€ 2,00
ID/02736900	CONNECTEUR D'ALIMENTATION 2500 MM	€ 3,20
ID/02736901	CONNECTEUR INTERMÉDIAIRE 300 MM	€ 4,40

Contrôleurs voir page 30 - 36
Convertisseurs voir page 444 - 445

REGLETTES LED & SOUS MEUBLES

REGULED



- Grâce au câblage traversant, il est possible de connecter plusieurs appareils sans interruption lumineuse et sans accessoire spécifique
- Livré avec attaches métalliques et vis
- Diffuseur opalin
- Ballast électronique intégré
- Interrupteur ON/OFF intégré

RÉF. ID	PUISSANCE	FLUX	T°	DIMENSIONS (MM)	PRIX HTVA
ID/01581126	4W	300 LM	3000°K	313 X 22 X 30	€ 12,40
ID/01893257	4W	320 LM	4000°K	313 X 22 X 30	€ 12,40
ID/01581127	8W	600 LM	3000°K	573 X 22 X 36	€ 15,40
ID/01893258	8W	640 LM	4000°K	573 X 22 X 36	€ 15,40
ID/01581128	10W	750 LM	3000°K	873 X 22 X 36	€ 17,00
ID/01893259	10W	800 LM	4000°K	873 X 22 X 36	€ 17,00
ID/01581129	14W	1050 LM	3000°K	1173 X 22 X 36	€ 22,00
ID/01893260	14W	1120 LM	4000°K	1173 X 22 X 36	€ 22,00
ID/01581130	18W	1350 LM	3000°K	1473 X 22 X 30	€ 31,00
ID/01893261	18W	1440 LM	4000°K	1473 X 22 X 30	€ 31,00



ELIR

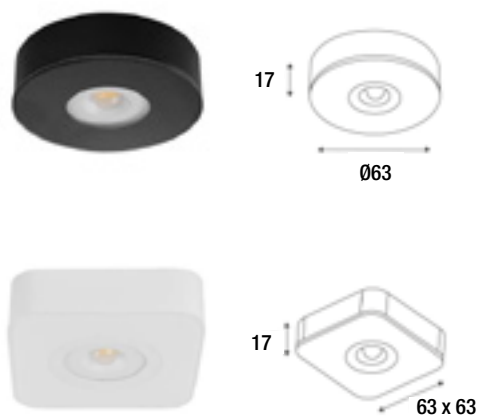

RÉF. ID	PUISSANCE	FLUX	T°	TENSION	COULEUR	FORMAT	PRIX HTVA
ID/02682270	4W	285 LM	3000°K	230V	○ BLANC	ROND	€ 45,00
ID/02682269	4W	285 LM	3000°K	230V	● NOIR	ROND	€ 45,00
ID/02682272	4W	285 LM	3000°K	230V	○ BLANC	CARRE	€ 50,00
ID/02682271	4W	285 LM	3000°K	230V	● NOIR	CARRE	€ 50,00

SPOTS ENCASTRÉS

PAGES 40 À 81

Dans les faux-plafonds ou les hourdis, les spots encastrés constituent la base la plus utilisée à l'heure actuelle pour éclairer un espace. Large, petit, rond, carré, orientable ou non, affleurant ou rentrant, lumière chaude ou froide, module led, GU10 ou led intégré... sont autant de caractéristiques et de possibilités pour s'adapter parfaitement à votre projet et vos envies.



CLASSIFICATION DES SPOTS PAR Ø D'ENCASTREMENT

NOM	ENCASTREMENT MM	PAGE	IP	PUISSANCE	TYPE	DIMMABLE	ORIENTABLE	FIXATION
TIBLI R-B	Ø 25	71	IP23	1,2W	LED			LAMELLES
SPOTI R-B	Ø 35	72	IP 44	4,5 W	LED			LAMELLES
ANKARA	Ø 43	72	IP 20	5 W	LED		15°	RESSORTS
STRASBOURG MICRO	Ø 44	77	IP 20	2 W	LED	✓	60°	LAMELLES
LISY RD	Ø 45	70	IP23	4,5W	LED	✓		RESSORTS
LISY RDX	Ø 58	70	IP23	4.5W	LED	✓	20°	RESSORTS
EVOLVED	Ø 62	50	IP 44	8 W	LED	✓		RESSORTS
STRASBOURG MINI	Ø 64	78	IP 20	6,2 W	LED	✓	90°	LAMELLES
ABY 1 RD	Ø 68	58	IP23	6,5W	LED	✓		RESSORTS
COPE RD	Ø 68	59	IP65	7W	LED	✓		RESSORTS
DEBI RD	Ø 68	52	IP65	6W	LED	✓		RESSORTS
DEBI RD-230	Ø 68	52	IP65	5W	LED	✓		RESSORTS
IENA RDX	Ø 68	53	IP65	6W	LED	✓	30°	RESSORTS
IENA RDX-230	Ø 68	53	IP65	5W	LED	✓	30°	RESSORTS
KUANA S	Ø 68	74	IP54	9W	LED			RESSORTS
LARY RD	Ø 68	62	IP65	9W	LED	✓		RESSORTS
LARY SD	Ø 68	62	IP65	9W	LED	✓		RESSORTS
SWEET RD	Ø 68	56	IP54	8W	LED	✓		RESSORTS
SWEET RD A	Ø 68	56	IP54	8W	LED	✓		RESSORTS
SWEET RD A WARM	Ø 68	56	IP54	6W	LED	✓		RESSORTS
SWEET RD WARM	Ø 68	56	IP20	6W	LED	✓		RESSORTS
AL1014 R	Ø 68	54	IP 44	6 W	LED		20°	RESSORTS
AL1014 RDX	Ø 68	54	IP 44	9 W	LED	✓	20°	RESSORTS
HD1014 R	Ø 68	55	IP 65	6 W	LED			RESSORTS
ALIS1014 R	Ø 68	55	IP 65	9 W	LED	✓	30°	RESSORTS
MINI CLIC	Ø 68	80	IP 20	8 W	LED	✓	90°	RESSORTS
JUNISTAR ECO	Ø 68-83	60	IP44	6W	LED	✓		RESSORTS
EXOLED	Ø 68	51	IP65	7W	LED	✓		RESSORTS
IXOLED	Ø 68	51	IP65	5W	LED	✓		RESSORTS

CLASSIFICATION DES SPOTS PAR Ø D'ENCASTREMENT

NOM	ENCASTREMENT MM	PAGE	IP	PUISSANCE	TYPE	DIMMABLE	ORIENTABLE	FIXATION
KARTY	Ø 73	80	IP 20	8 W	LED	✓	45°	RESSORTS
SPOT BASE IP54	Ø 75	48	IP 54	MAX 9W	GU10	✓		RESSORTS
SPOT BASE	Ø 75	48	IP 20	MAX 9W	GU10	✓		RESSORTS
SYLA-B	Ø 75	75	IP 23	10 W	LED			LAMELLES
TITAN FIX ROUND	Ø 76	63	IP 20	8,9 W	LED	✓		RESSORTS
TITAN MIX	Ø 76	63	IP 20	8,9 W	LED	✓	40°	RESSORTS
GARI TRIMLESS	Ø 78	64	IP 23	7 W	LED	✓	30°	KIT ENCAS.
GARI	Ø 78	64	IP 23	7 W	LED	✓	30°	RESSORTS
DUCA TRIMLESS	Ø 78	66	IP 23	7 W	LED	✓	30°	KIT ENCAS.
DUCA	Ø 78	66	IP 23	7 W	LED	✓	30°	RESSORTS
ABY 2 RD	Ø 80	58	IP23	9W	LED	✓		RESSORTS
NEWTA	Ø 80	47	IP20	MAX 9W	GU10			RESSORTS
VAL THORENS	Ø 80	50	IP65	14W	LED	✓		RESSORTS
WATTO LAMELLES	Ø 80	46	IP20	MAX 9W	GU10		40°	LAMELLES
WATTO RESSORTS	Ø 80	46	IP20	MAX 9W	GU10		40°	RESSORTS
JUNISTAR ISOSAFE	Ø 83	60	IP44	8.5W	LED	✓	30°	RESSORTS
JUNISTAR LUX ISOSAFE	Ø 83	61	IP44	8W	LED	✓		RESSORTS
STRASBOURG	Ø 89	79	IP 20	9,2 W	LED	✓	90°	RESSORTS
ABY 3 RD	Ø 92	59	IP23	15W	LED	✓		RESSORTS
GARI P TRIMLESS	Ø 100	65	IP 23	13 W	LED	✓	30°	KIT ENCAS.
GARI P	Ø 100	65	IP 23	13 W	LED	✓	30°	RESSORTS
DUCA P TRIMLESS	Ø 100	67	IP 23	13 W	LED	✓	30°	KIT ENCAS.
DUCA P	Ø 100	67	IP 23	13 W	LED	✓	30°	RESSORTS
FILI 1 RX GU10	Ø 102	49	IP20	MAX 9W	GU10		45°	RESSORTS
LENA TRIMLESS	78 X 72	68	IP 23	7 W	LED	✓	30°	KIT ENCAS.
LENA	78 X 78	68	IP 23	7 W	LED	✓	30°	RESSORTS
LENA P	102 X 102	69	IP 23	13 W	LED	✓	30°	RESSORTS
LENA P TRIMLESS	104 X 97	69	IP 23	13 W	LED	✓	30°	KIT ENCAS.

SPOTS ENCASTRÉS

INNOVLED



Module LED extra plat dernière génération avec un CRI > 90. Grâce à sa bague de finition blanche, noire ou aluminium, ce module peut s'adapter à la majorité des collerettes standards. Il permet de créer des projets infinis grâce à ses différents angles et teintes de couleur. Driver compact non dimmable inclus.



MODULE COMPATIBLE AVEC LES SPOTS ENCASTRÉS

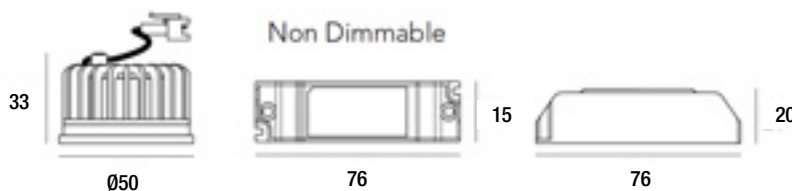

Le conseil de l'éclairagiste:

Un module led possède une durée de vie plus longue, de meilleures performances et une bien meilleure fiabilité par rapport à une lampe led GU10 ou MR16 (retrofit).

NEW

RÉF. ID	PUISSANCE	FLUX	T°	COULEUR	ANGLE	PRIX HTVA
ID/03517632	7W	680 LM	2700°K	○ BLANC	24 °	€ 26,00
ID/03517629	7W	680 LM	2700°K	○ BLANC	40 °	€ 26,00
ID/03517635	7W	680 LM	2700°K	○ BLANC	60 °	€ 26,00
ID/03517633	7W	630 LM	3000°K	○ BLANC	24 °	€ 26,00
ID/03517630	7W	630 LM	3000°K	○ BLANC	40 °	€ 26,00
ID/03517636	7W	630 LM	3000°K	○ BLANC	60 °	€ 26,00
ID/03517634	7W	580 LM	4000°K	○ BLANC	24 °	€ 26,00
ID/03517631	7W	580 LM	4000°K	○ BLANC	40 °	€ 26,00
ID/03517637	7W	580 LM	4000°K	○ BLANC	60 °	€ 26,00

INNOVLED TRIAC



Module LED extra plat dernière génération avec un CRI > 90. Grâce à sa bague de finition blanche, noire ou aluminium, ce module peut s'adapter à la majorité des collerettes standards. Il permet de créer des projets infinis grâce à ses différents angles et teintes de couleur. Driver compact dimmable inclus.



MODULE DIMMABLE TRIAC

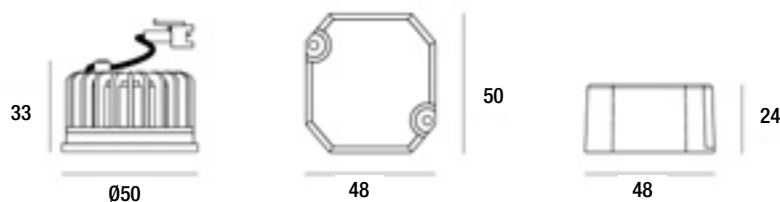

NEW

RÉF. ID	PUISSANCE	FLUX	T°	COULEUR	ANGLE	PRIX HTVA
ID/03517642	7W	680 LM	2700°K	○ BLANC	24 °	€ 33,00
ID/03517638	7W	680 LM	2700°K	○ BLANC	40 °	€ 33,00
ID/03517645	7W	680 LM	2700°K	○ BLANC	60 °	€ 33,00
ID/03517643	7W	630 LM	3000°K	○ BLANC	24 °	€ 33,00
ID/03517639	7W	630 LM	3000°K	○ BLANC	40 °	€ 33,00
ID/03517646	7W	630 LM	3000°K	○ BLANC	60 °	€ 33,00
ID/03517644	7W	580 LM	4000°K	○ BLANC	24 °	€ 33,00
ID/03517640	7W	580 LM	4000°K	○ BLANC	40 °	€ 33,00
ID/03517647	7W	580 LM	4000°K	○ BLANC	60 °	€ 33,00
ID/03517641	7W	DIM-TO-WARM	2700 - 3000°K	○ BLANC	40 °	€ 43,00

ACCESSOIRES POUR INNOVLED

RÉF. ID	ACCESSOIRES EN OPTION	PRIX HTVA
ID/03517649	COLLERETTE ALU BROSSÉ POUR MODULE LED	€ 2,00
ID/03517648	COLLERETTE NOIR STRUCTURÉ POUR MODULE LED	€ 2,00

SPOTS ENCASTRÉS

WATTO



Ce spot encastrable a une ligne très pure et une forme moderne lui permettant de s'intégrer à l'ambiance souhaitée. Bague intérieure orientable.

Source compatible :
PAR16 - GU10 ou Module LED INNOVLED
Fixations par ressorts ou par lamelles
Bornier automatique GU10 à double raccordement

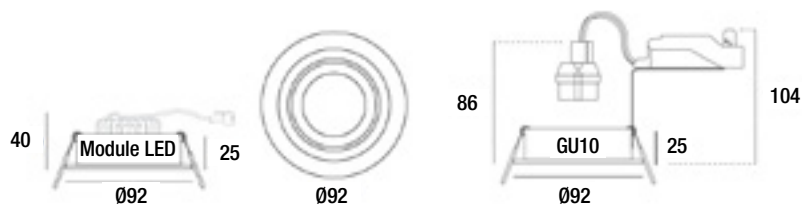

NEW

RÉF. ID	CULOT	COULEUR	FIXATIONS	ENCASTREMENT MM	MATÉRIAU	PRIX HTVA
ID/03517613	GU10	○ BLANC	RESSORTS	Ø 80	ALUMINIUM	€ 15,90
ID/03517614	GU10	○ BLANC	LAMELLES	Ø 80	ALUMINIUM	€ 15,90
ID/03517615	GU10	● NOIR	RESSORTS	Ø 80	ALUMINIUM	€ 15,90
ID/03517616	GU10	● NOIR	LAMELLES	Ø 80	ALUMINIUM	€ 15,90
ID/03517617	GU10	● ALU BROSSE	RESSORTS	Ø 80	ALUMINIUM	€ 15,90
ID/03517618	GU10	● ALU BROSSE	LAMELLES	Ø 80	ALUMINIUM	€ 15,90
ID/03517619	MODULE LED	○ BLANC	RESSORTS	Ø 80	ALUMINIUM	€ 15,90
ID/03517620	MODULE LED	○ BLANC	LAMELLES	Ø 80	ALUMINIUM	€ 15,90
ID/03517621	MODULE LED	● NOIR	RESSORTS	Ø 80	ALUMINIUM	€ 15,90
ID/03517622	MODULE LED	● NOIR	LAMELLES	Ø 80	ALUMINIUM	€ 15,90
ID/03517623	MODULE LED	● ALU BROSSE	RESSORTS	Ø 80	ALUMINIUM	€ 15,90
ID/03517624	MODULE LED	● ALU BROSSE	LAMELLES	Ø 80	ALUMINIUM	€ 15,90

NEWTA

5 ANS

IP20



230V



Ce spot encastrable basse luminance a une ligne très pure et une forme moderne lui permettant de s'intégrer à l'ambiance souhaitée.

Source compatibles :
PAR16 - GU10 ou Module LED INNOVLED.
Fixations par ressorts;
Bornier automatique GU10 à double raccordement

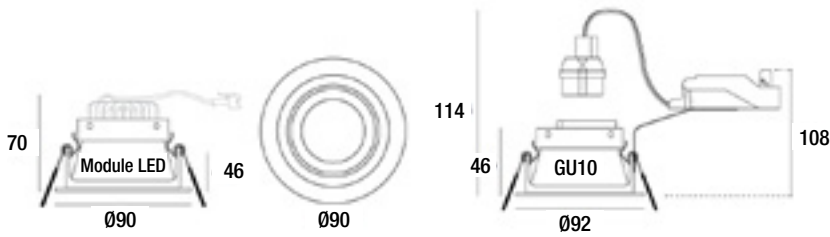

NEW

RÉF. ID	CULOT	COULEUR	ENCASTREMENT MM	MATÉRIAU	PRIX HTVA
ID/03517625	GU10	○ BLANC	$\varnothing 80$	ALUMINIUM	€ 15,90
ID/03517626	GU10	● NOIR	$\varnothing 80$	ALUMINIUM	€ 15,90
ID/03517627	MODULE LED	○ BLANC	$\varnothing 80$	ALUMINIUM	€ 15,90
ID/03517628	MODULE LED	● NOIR	$\varnothing 80$	ALUMINIUM	€ 15,90



SPOTS ENCASTRÉS

SPOT BASE

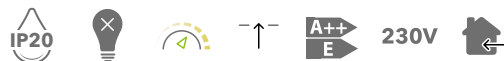

- Basse luminance
- Livré sans socket
- Compatible GU10
- Compatible module led p.44-45
- Fixation par ressorts

Le conseil de l'éclairagiste:
Un luminaire basse luminance améliore le confort visuel en limitant d'éventuelles sensations d'éblouissement.

RÉF. ID	COULEUR	ENCASTREMENT MM	MATÉRIAU	PRIX HTVA
ID/02775562	○ BLANC	Ø 75	ALUMINIUM	€ 14,10
ID/02775563	● NOIR	Ø 75	ALUMINIUM	€ 14,10

SPOT BASE IP54



- Basse luminance
- Livré sans socket
- Étanche
- Compatible GU10
- Compatible module led p.44-45
- Fixation par ressorts

RÉF. ID	COULEUR	ENCASTREMENT MM	MATÉRIAU	PRIX HTVA
ID/02775564	○ BLANC	Ø 75	ALUMINIUM	€ 15,50
ID/03468779	● NOIR MAT	Ø 75	ALUMINIUM	€ 15,50

FILI 1 RX GU10



- Downlight semi-encastré rond orientable
- Fixation par ressorts

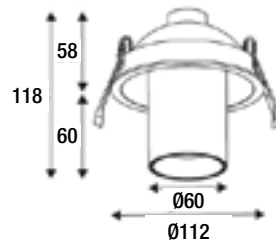

NEW

RÉF. ID	CULOT	PUISSANCE MAX	FLUX MAX	COULEUR	ENCASTREMENT MM	MATÉRIAU	PRIX HTVA
ID/03382785	GU10	MAX 9W	575 LM	○ BLANC MAT	Ø 102	ALUMINIUM	€ 49,00
ID/03382784	GU10	MAX 9W	575 LM	● NOIR MAT	Ø 102	ALUMINIUM	€ 49,00



SPOTS ENCASTRÉS LED

EVOLED



RECOURVABLE
ISOLANT



FAIBLE
ENCOMBREMENT

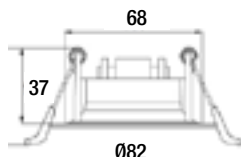

- Spot + Driver recouvrables par de l'isolant en rouleaux ou à souffler
- Respecte les impératifs en matière d'éco-conception et de suppression des ponts thermiques grâce à un produit étanche à l'air
- Convertisseur dimmable Triac inclus
- Étanche

RÉF. ID	PUISSANCE	FLUX	T°	COULEUR	ENCASTREMENT MM	PRIX HTVA
ID/02846148	8W	650 LM	3000°K	○ BLANC	Ø 62	€ 39,00
ID/02846147	8W	650 LM	3000°K	● NOIR	Ø 62	€ 39,00
ID/02846150	8W	760 LM	4000°K	○ BLANC	Ø 62	€ 39,00
ID/02846149	8W	760 LM	4000°K	● NOIR	Ø 62	€ 39,00

VAL THORENS

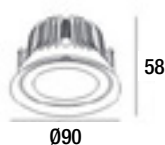

- Fixation par ressorts
- Convertisseur non dimmable déporté inclus
- Convertisseur dimmable 350mA (voir p.446)

NEW

RÉF. ID	PUISSANCE	FLUX	T°	COULEUR	ENCASTREMENT MM	MATÉRIAU	PRIX HTVA
ID/03383104	7W	600 LM	3000°K	○ BLANC	Ø 80	ALUMINIUM	€ 53,00
ID/03383105	7W	600 LM	3000°K	● NOIR	Ø 80	ALUMINIUM	€ 53,00
ID/02679178	14W	1195 LM	3000°K	○ BLANC	Ø 80	ALUMINIUM	€ 70,00
ID/02679179	14W	1195 LM	3000°K	● NOIR	Ø 80	ALUMINIUM	€ 70,00

SPOTS ENCASTRÉS LED

IXOLED

LED 3 ANS IP65 60° IRC 80 TRIAC 230V



- Étanche à l'eau et à l'air
- Pré-câblage pour faciliter le montage
- Fixation par ressorts

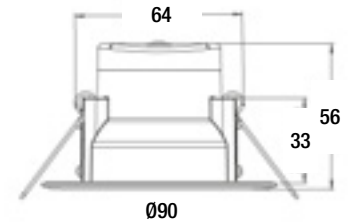

NEW

RÉF. ID	PUISSANCE	FLUX	T°	COULEUR	ENCASTREMENT MM	PRIX HTVA
ID/03547712	5W	470-520 LM	2700 - 4000°K	○ BLANC	Ø 68	€ 23,00
ID/03547713	5W	470-520 LM	2700 - 4000°K	● NOIR	Ø 68	€ 23,00

EXOLED

LED 3 ANS IP65 60° IRC 80 TRIAC 230V

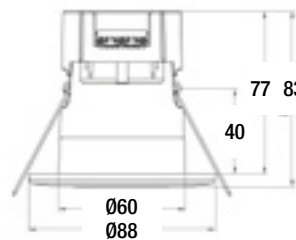
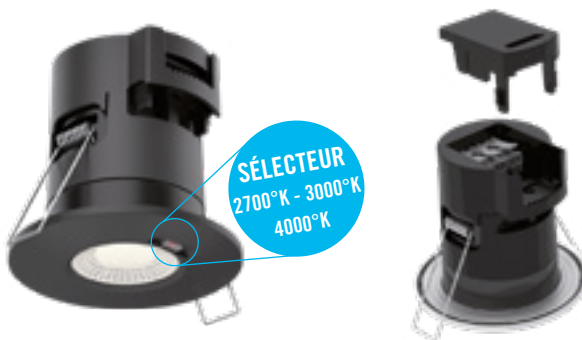

- Étanche à l'eau et à l'air
- Collerette blanche incluse
- Sélecteur de couleur : 2700 / 3000 / 4000 K sur l'avant
- Fixation par ressorts



NEW

RÉF. ID	PUISSANCE	FLUX	T°	COULEUR	ENCASTREMENT MM	PRIX HTVA
ID/03547714	7W	560 -600 LM	2700 - 4000°K	○ BLANC	Ø 68	€ 32,00
ID/03547715						€ 2,90
ID/03546866						€ 2,90
ID/03546867						€ 2,90
ID/03546870						€ 3,90
ID/03546868						€ 3,90
ID/03546869						€ 3,90

SPOTS ENCASTRÉS LED

DEBI RD-230

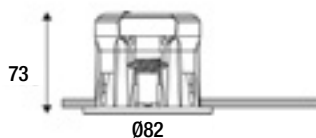
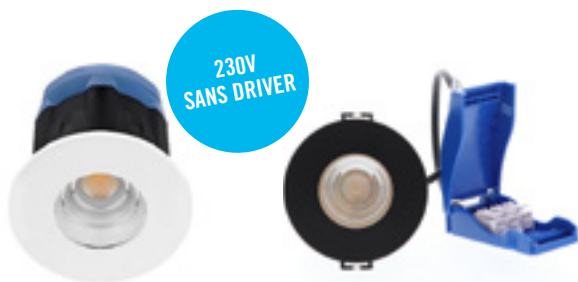

- Spot encastré rond fixe 4 en 1
- 2700K, 3000K, 4000K ou 6000K au choix via un switch à l'arrière du luminaire
- Peut être recouvert par un isolant déroulé ou soufflé
- Double bornier automatique
- Ne nécessite pas de convertisseur
- Compatible avec variateur fin de phase
- Fixation par ressorts

NEW

RÉF. ID	PUISSANCE	FLUX	T°	COULEUR	ENCASTREMENT MM	MATÉRIAU	PRIX HTVA
ID/03382787	5W	506 LM	2700 - 6000°K	○ BLANC MAT	Ø 68	ALUMINIUM/COMPOSITE	€ 35,00
ID/03382786	5W	506 LM	2700 - 6000°K	● NOIR MAT	Ø 68	ALUMINIUM/COMPOSITE	€ 35,00

DEBI RD

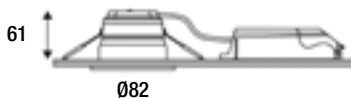

- Spot encastré rond fixe 4 en 1
- 2700K, 3000K, 4000K ou 6000K au choix via un interrupteur à l'arrière du luminaire
- Peut être recouvert par un isolant déroulé ou soufflé
- Double bornier automatique
- Convertisseur dimmable déporté fourni
- Compatible avec variateur fin de phase
- Fixation par ressorts

Le conseil de l'éclairagiste:

Le boîtier de connexion rapide à double raccordement, c'est un gain de temps et de matériel... et donc un gain d'argent. Pensez-y dans le choix de vos luminaires !

NEW

RÉF. ID	PUISSANCE	FLUX	T°	COULEUR	ENCASTREMENT MM	MATÉRIAU	PRIX HTVA
ID/03286948	6W	570 LM	2700 - 6000°K	○ BLANC MAT	Ø 68	ALUMINIUM/COMPOSITE	€ 40,00
ID/03382782	6W	570 LM	2700 - 6000°K	● NOIR MAT	Ø 68	ALUMINIUM/COMPOSITE	€ 40,00

SPOTS ENCASTRÉS LED

IENA RDX-230

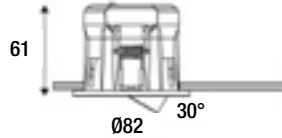

- Spot encastré rond orientable 4 en 1
- 2700K, 3000K, 4000K ou 6000K au choix via un switch à l'arrière du luminaire
- Peut être recouvert par un isolant déroulé ou soufflé.
- Double bornier automatique
- Ne nécessite pas de convertisseur
- Compatible avec variateur fin de phase
- Fixation par ressorts

NEW

RÉF. ID	PUISSANCE	FLUX	T°	COULEUR	ENCASTREMENT MM	MATÉRIAU	PRIX HTVA
ID/03382789	5W	506 LM	2700 - 6000°K	○ BLANC MAT	Ø 68	ALUMINIUM	€ 39,00
ID/03382788	5W	506 LM	2700 - 6000°K	● NOIR MAT	Ø 68	ALUMINIUM	€ 39,00

IENA RDX

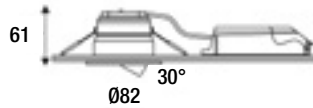

- Spot encastré rond orientable 4 en 1
- 2700K, 3000K, 4000K ou 6000K au choix via un switch à l'arrière du luminaire
- Peut être recouvert par un isolant déroulé ou soufflé
- Double bornier automatique
- Compatible avec variateur fin de phase
- Fixation par ressorts

NEW

RÉF. ID	PUISSANCE	FLUX	T°	COULEUR	ENCASTREMENT MM	MATÉRIAU	PRIX HTVA
ID/03286949	6W	600 LM	2700 - 6000°K	○ BLANC MAT	Ø 68	ALUMINIUM	€ 45,00
ID/03382783	6W	570 LM	2700 - 6000°K	● NOIR MAT	Ø 68	ALUMINIUM	€ 45,00

SPOTS ENCASTRÉS LED

AL1014 R

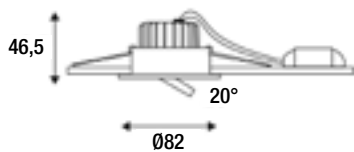

- Spot encastré rond orientable
- Fonte d'aluminium
- Fixation par ressorts
- Convertisseur déporté inclus
- Convertisseur dimmable 350mA (voir p. ,446)

RÉF. ID	PUISSANCE	FLUX	T°	COULEUR	ENCASTREMENT MM	PRIX HTVA
ID/01253229	6W	655 LM	3000°K	○ BLANC MAT	Ø 68	€ 40,00
ID/01253230	6W	655 LM	3000°K	● ALU BROSSE	Ø 68	€ 40,00
ID/01477701	6W	705 LM	4000°K	○ BLANC MAT	Ø 68	€ 45,00
ID/01477700	6W	705 LM	4000°K	● ALU BROSSE	Ø 68	€ 45,00

AL1014 RDX

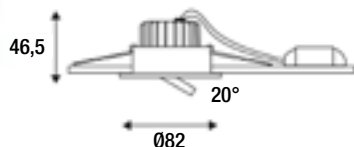

- Spot encastré rond orientable
- Fixation par ressorts
- Température de couleur variable de 1800K à 3000K suivant l'intensité de dimming
- Convertisseur dimmable déporté inclus
- Compatible avec variateur début et fin de phase

Le conseil de l'éclairagiste:

Augmenter la chaleur de la lumière en diminuant l'intensité lumineuse, c'est désormais possible grâce aux spots led Dim-to-Warm. Top pour créer des ambiances cocoon et chaleureuses !

RÉF. ID	PUISSANCE	FLUX	T°	COULEUR	ENCASTREMENT MM	PRIX HTVA
ID/02682316	6W	465 LM	1800 - 3000°K	○ BLANC	Ø 68	€ 77,00
ID/02682315	6W	465 LM	1800 - 3000°K	● NOIR MAT	Ø 68	€ 77,00

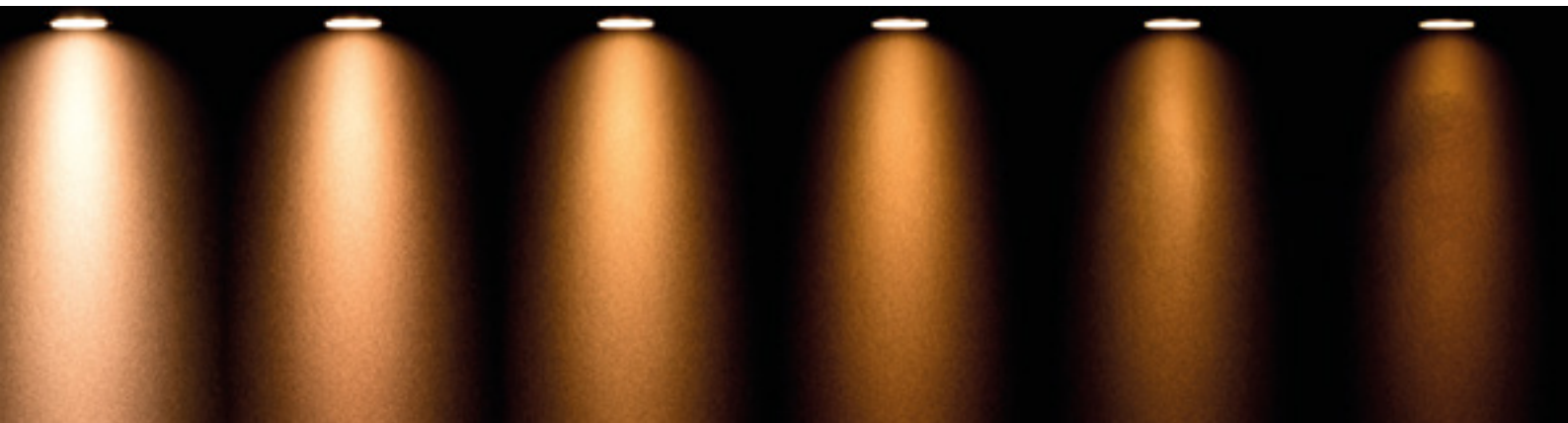

SPOTS ENCASTRÉS LED

HD1014 R



- Spot encastré rond fixe
- Fonte d'aluminium
- Fixation par ressorts
- Peut être recouvert par un isolant déroulé
- Convertisseur non dimmable déporté inclus
- Convertisseur dimmable 350mA (voir p.446)

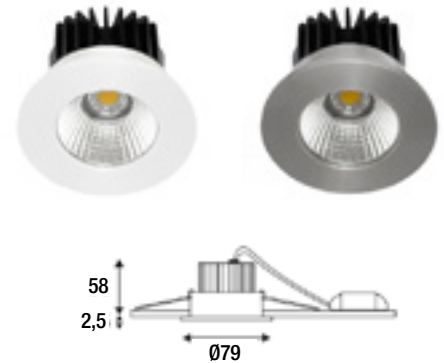

RÉF. ID	PUISSANCE	FLUX	T°	COULEUR	ENCASTREMENT MM	PRIX HTVA
ID/01286619	6W	655 LM	3000°K	○ BLANC MAT	Ø 68	€ 52,00
ID/01286618	6W	655 LM	3000°K	● ALU BROSSE	Ø 68	€ 52,00
ID/01477695	6W	705 LM	4000°K	○ BLANC MAT	Ø 68	€ 52,00
ID/01477694	6W	705 LM	4000°K	● ALU BROSSE	Ø 68	€ 52,00

ALIS 1014 R

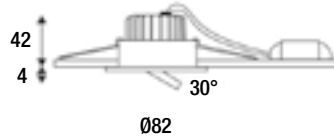

- Spot encastré rond orientable
- Fonte d'aluminium
- Fixation par ressorts
- Avec membrane pour préserver l'étanchéité à l'air
- Convertisseur dimmable Triac déporté inclus

RÉF. ID	PUISSANCE	FLUX	T°	COULEUR	ENCASTREMENT MM	PRIX HTVA
ID/02223548	9W	675 LM	3000°K	○ BLANC MAT	Ø 68	€ 63,00
ID/02223547	9W	675 LM	3000°K	● NOIR MAT	Ø 68	€ 63,00
ID/02223546	9W	730 LM	4000°K	○ BLANC MAT	Ø 68	€ 63,00
ID/02223545	9W	730 LM	4000°K	● NOIR MAT	Ø 68	€ 63,00

SPOTS ENCASTRÉS LED

SWEET RD & RD WARM

LED

5 ANS

IP54



60°

IRC ≥90



TRIAC



A++
A

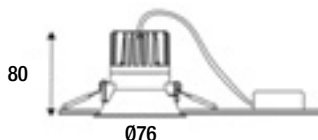

- Spot encastré rond fixe
- Réflecteur basse luminance
- Double bornier automatique
- Convertisseur dimmable déporté fourni
- Compatible avec variateur fin de phase
- Bague couvrant un diamètre de perçage de 90 à 120mm sur demande
- Modèle Dim-to-warm, température de couleur variable de 1800K à 3000K suivant l'intensité de dimming
- Fixation par ressorts



Le conseil de l'éclairagiste:

Un luminaire basse luminance améliore le confort visuel en limitant d'éventuelles sensations d'éblouissement.

NEW

RÉF. ID	PUISSANCE	FLUX	T°	COULEUR	ENCASTREMENT MM	MATÉRIAU	PRIX HTVA
ID/03382796	8W	600 LM	2700°K	○ BLANC MAT	Ø 68	COMPOSITE	€ 49,00
ID/03382795	8W	600 LM	2700°K	● NOIR MAT	Ø 68	COMPOSITE	€ 49,00
ID/03382799	8W	600 LM	2700°K	◐ BLANC MAT/NOIR	Ø 68	COMPOSITE	€ 52,00
ID/03382797	8W	600 LM	2700°K	◑ BLANC MAT/CHAMPAGNE	Ø 68	COMPOSITE	€ 52,00
ID/03382801	8W	650 LM	3000°K	○ BLANC MAT	Ø 68	COMPOSITE	€ 49,00
ID/03382800	8W	650 LM	3000°K	● NOIR MAT	Ø 68	COMPOSITE	€ 49,00
ID/03382804	8W	650 LM	3000°K	◐ BLANC MAT/NOIR	Ø 68	COMPOSITE	€ 52,00
ID/03382802	8W	650 LM	3000°K	◑ BLANC MAT/CHAMPAGNE	Ø 68	COMPOSITE	€ 52,00
ID/03382821	6W	530 LM	1800 - 3000°K	○ BLANC MAT	Ø 68	COMPOSITE	€ 70,00
ID/03382820	6W	530 LM	1800 - 3000°K	● NOIR MAT	Ø 68	COMPOSITE	€ 70,00
ID/03382824	6W	530 LM	1800 - 3000°K	◐ BLANC MAT/NOIR	Ø 68	COMPOSITE	€ 70,00
ID/03382822	6W	530 LM	1800 - 3000°K	◑ BLANC MAT/CHAMPAGNE	Ø 68	COMPOSITE	€ 70,00

SPOTS ENCASTRÉS LED

SWEET RD A & RD A WARM

LED

5
ANS

IP54



IRC
≥90



TRIAC



A++
A



SPOTS ENCASTRÉS



ASYMÉTRIQUE

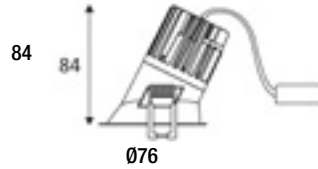

- Asymétrique
- Réflecteur basse luminance
- Double bornier automatique
- Convertisseur dimmable déporté fourni
- Compatible avec variateur fin de phase
- Modèle Dim-to-warm, température de couleur variable de 1800K à 3000K suivant l'intensité de dimming
- Fixation par ressorts

Le conseil de l'éclairagiste:

Une diffusion lumineuse asymétrique permet de décentrer le faisceau lumineux, permettant d'éclairer, par exemple, un tableau ou un mur avec le recul nécessaire pour embrasser la surface voulue et tout en limitant les possibilités d'éblouissement.

NEW

RÉF. ID	PUISSANCE	FLUX	T°	COULEUR	ENCASTREMENT MM	MATÉRIAU	PRIX HTVA
ID/03382811	8W	600 LM	2700°K	○ BLANC MAT	Ø 68	COMPOSITE	€ 50,00
ID/03382810	8W	600 LM	2700°K	● NOIR MAT	Ø 68	COMPOSITE	€ 50,00
ID/03382814	8W	600 LM	2700°K	◐ BLANC MAT/NOIR	Ø 68	COMPOSITE	€ 52,00
ID/03382812	8W	600 LM	2700°K	◑ BLANC MAT/CHAMPAGNE	Ø 68	COMPOSITE	€ 52,00
ID/03382816	8W	650 LM	3000°K	○ BLANC MAT	Ø 68	COMPOSITE	€ 50,00
ID/03382815	8W	650 LM	3000°K	● NOIR MAT	Ø 68	COMPOSITE	€ 50,00
ID/03382819	8W	650 LM	3000°K	◐ BLANC MAT/NOIR	Ø 68	COMPOSITE	€ 52,00
ID/03382817	8W	650 LM	3000°K	◑ BLANC MAT/CHAMPAGNE	Ø 68	COMPOSITE	€ 52,00
ID/03382826	6W	530 LM	1800 - 3000°K	○ BLANC MAT	Ø 68	COMPOSITE	€ 70,00
ID/03382825	6W	530 LM	1800 - 3000°K	● NOIR MAT	Ø 68	COMPOSITE	€ 70,00
ID/03382829	6W	530 LM	1800 - 3000°K	◐ BLANC MAT/NOIR	Ø 68	COMPOSITE	€ 70,00
ID/03382827	6W	530 LM	1800 - 3000°K	◑ BLANC MAT/CHAMPAGNE	Ø 68	COMPOSITE	€ 70,00

SPOTS ENCASTRÉS LED

ABY 1 RD



- Réflecteur basse luminance
- Convertisseur dimmable déporté fourni
- Compatible avec variateur début et fin de phase
- Fixation par ressorts

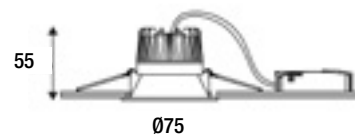

NEW

RÉF. ID	PUISSANCE	FLUX	T°	COULEUR	ENCASTREMENT MM	MATÉRIAU	PRIX HTVA
ID/03382841	6,5W	519 LM	3000°K	○ BLANC MAT	Ø 68	ALUMINIUM	€ 52,00
ID/03382840	6,5W	519 LM	3000°K	● NOIR MAT	Ø 68	ALUMINIUM	€ 52,00
ID/03382839	6,5W	600 LM	4000°K	○ BLANC MAT	Ø 68	ALUMINIUM	€ 52,00
ID/03382838	6,5W	600 LM	4000°K	● NOIR MAT	Ø 68	ALUMINIUM	€ 52,00

ABY 2 RD



- Réflecteur basse luminance
- Convertisseur dimmable déporté fourni
- Compatible avec variateur début et fin de phase
- Fixation par ressorts

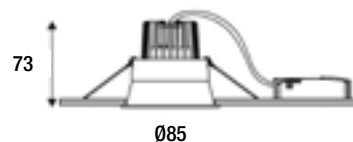

NEW

RÉF. ID	PUISSANCE	FLUX	T°	COULEUR	ENCASTREMENT MM	MATÉRIAU	PRIX HTVA
ID/03382845	9W	680 LM	3000°K	○ BLANC MAT	Ø 80	ALUMINIUM	€ 59,00
ID/03382844	9W	680 LM	3000°K	● NOIR MAT	Ø 80	ALUMINIUM	€ 59,00
ID/03382843	9W	860 LM	4000°K	○ BLANC MAT	Ø 80	ALUMINIUM	€ 59,00
ID/03382842	9W	860 LM	4000°K	● NOIR MAT	Ø 80	ALUMINIUM	€ 59,00

SPOTS ENCASTRÉS LED

ABY 3 RD



- Réflecteur basse luminance
- Convertisseur dimmable déporté fourni
- Compatible avec variateur début et fin de phase
- Fixation par ressorts

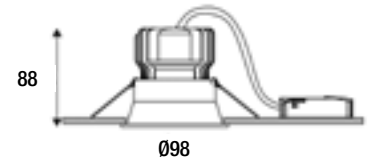

NEW

RÉF. ID	PUISSANCE	FLUX	T°	COULEUR	ENCASTREMENT MM	MATÉRIAU	PRIX HTVA
ID/03382849	15W	1151 LM	3000°K	○ BLANC MAT	Ø 92	ALUMINIUM	€ 77,00
ID/03382848	15W	1151 LM	3000°K	● NOIR MAT	Ø 92	ALUMINIUM	€ 77,00
ID/03382847	15W	1447 LM	4000°K	○ BLANC MAT	Ø 92	ALUMINIUM	€ 77,00
ID/03382846	15W	1447 LM	4000°K	● NOIR MAT	Ø 92	ALUMINIUM	€ 77,00

COPE RD



FAIBLE ENCOMBREMENT

- Réflecteur basse luminance
- Convertisseur dimmable déporté fourni
- Compatible avec variateur début et fin de phase
- Fixation par ressorts

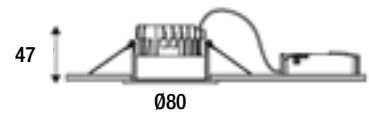

NEW

RÉF. ID	PUISSANCE	FLUX	T°	COULEUR	ENCASTREMENT MM	MATÉRIAU	PRIX HTVA
ID/03382853	7W	621 LM	3000°K	○ BLANC MAT	Ø 68	ALUMINIUM	€ 55,00
ID/03382852	7W	621 LM	3000°K	● NOIR MAT	Ø 68	ALUMINIUM	€ 55,00
ID/03382851	7W	644 LM	4000°K	○ BLANC MAT	Ø 68	ALUMINIUM	€ 55,00
ID/03382850	7W	644 LM	4000°K	● NOIR MAT	Ø 68	ALUMINIUM	€ 55,00

SPOTS ENCASTRÉS LED

JUNISTAR ECO

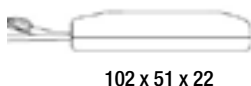
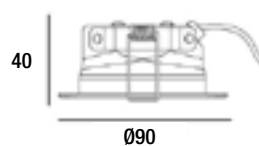

Avec une faible profondeur et un diamètre d'encastrement de Ø68-83mm, Junistar Eco est un encastré de choix pour les rénovations d'anciens plafonds.

- Orientable sur un axe
- Convertisseur dimmable déporté fourni
- Dimming par coupure de phase descendante
- Indice de rendu des couleurs exceptionnel
- Fixation par ressorts

NEW

RÉF. ID	PUISSANCE	FLUX	T°	COULEUR	ENCASTREMENT MM	MATÉRIAU	PRIX HTVA
ID/02949616	6W	520 LM	2700°K	○ BLANC	Ø 68-83	ALUMINIUM/VERRE	€ 388,00
ID/03298641	6W	490 LM	2700°K	● NOIR	Ø 68-83	ALUMINIUM/VERRE	€ 388,00
ID/03298640	6W	510 LM	2000-2800°K	○ BLANC	Ø 68-83	ALUMINIUM/VERRE	€ 388,00
ID/03298642	6W	470 LM	2000-2800°K	● NOIR	Ø 68-83	ALUMINIUM/VERRE	€ 388,00
ID/02949617	6W	550 LM	3000°K	○ BLANC	Ø 68-83	ALUMINIUM/VERRE	€ 388,00

JUNISTAR ISOSAFE TW



Junistar TW est un luminaire qui permet de régler sa température de couleur, de blanc chaud (2000K) à blanc froid (6500K) et en fonction du niveau de lux pour un éclairage résidentiel. Son fonctionnement est comparable à DimToWarm, mais avec un contrôle indépendant de l'intensité et de la température de la couleur. Grâce à TW LEDDIM Smart l'installation est facile car 2 câbles suffisent.

- Convertisseur dimmable déporté fourni.
- Dimming par coupure de phase descendante.
- Changement de teinte indépendante de la variation d'intensité
- Fixation par ressorts
- A combiner obligatoirement avec le variateur mural TW LEDDIM SMART (voir p. 451)

NEW

RÉF. ID	PUISSANCE	FLUX	T°	COULEUR	ENCASTREMENT MM	MATÉRIAU	PRIX HTVA
ID/03298643	8.5W	500 LM	2000 - 4000°K	○ BLANC	Ø 83	ALUMINIUM/VERRE	€ 75,00
ID/03298645	8.5W	460 LM	2000 - 4000°K	● NOIR	Ø 83	ALUMINIUM/VERRE	€ 75,00
ID/03298644	8.5W	530 LM	2700 - 6500°K	○ BLANC	Ø 83	ALUMINIUM/VERRE	€ 75,00
ID/03298646	8.5W	500 LM	2700 - 6500°K	● NOIR	Ø 83	ALUMINIUM/VERRE	€ 75,00

SPOTS ENCASTRÉS LED

JUNISTAR LUX ISOSAFE

LED

5 ANS

IP44

30°

42°

IRC 98

TRIAC

A++ A

↑ ↓

⚡

🏠

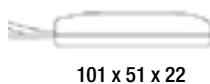
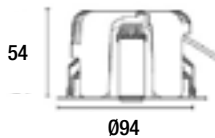

Junistar Lux offre une lumière harmonieuse et sans scintillement avec un excellent rendu des couleurs. Gyroscopique sur 360° (breveté) avec inclinaison sur 30°. Livré avec un nouveau boîtier de connexion offrant une meilleure résistance de traction pour plusieurs types de câbles, un plus grand espace pour les raccordements et un support pour câbles flexibles.

- Convertisseur dimmable déporté fourni
- Dimming par coupure de phase descendante
- Garantie anti-corrosion de 10 ans
- Fixation par ressorts

NEW

RÉF. ID	PUISSANCE	FLUX	T°	COULEUR	ENCASTREMENT MM	MATÉRIAU	PRIX HTVA
ID/02949639	8W	540 LM	2700°K	○ BLANC	Ø 83	ALUMINIUM/VERRE	€ 69,00
ID/02949644	8W	470 LM	2700°K	● NOIR	Ø 83	ALUMINIUM/VERRE	€ 69,00
ID/02949636	8W	480 LM	2700°K	● GRAPHITE	Ø 83	ALUMINIUM/VERRE	€ 69,00
ID/02949640	8W	560 LM	3000°K	○ BLANC	Ø 83	ALUMINIUM/VERRE	€ 69,00
ID/02949642	8W	490 LM	3000°K	● NOIR	Ø 83	ALUMINIUM/VERRE	€ 69,00
ID/02949637	8W	500 LM	3000°K	● GRAPHITE	Ø 83	ALUMINIUM/VERRE	€ 69,00
ID/02949641	8W	620 LM	4000°K	○ BLANC	Ø 83	ALUMINIUM/VERRE	€ 69,00
ID/02949643	8W	540 LM	4000°K	● NOIR	Ø 83	ALUMINIUM/VERRE	€ 69,00
ID/02949638	8W	550 LM	4000°K	● GRAPHITE	Ø 83	ALUMINIUM/VERRE	€ 69,00



Application maison et système domotique avec communication par Bluetooth

- Application gratuite disponible sur Google Play ou l'App Store
- Nombreuses fonctions pour piloter les tâches importantes, comme les scénarios, les minuteurs, les groupes, etc.
- SG Smart fonctionne avec l'Assistant Google et Alexa grâce à SG Smart Gateway
- Programmation et configuration les plus simples du marché, sans accessoires coûteux
- Compatible avec tous les produits SG à variation à coupure de phase

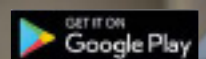

SPOTS ENCASTRÉS LED

LARY RD & LARY SD

LED

5 ANS

IP65



38°

IRC 80



TRIAC



A++ A



HAUT RENDEMENT



- Double bornier automatique
- Convertisseur dimmable déporté fourni
- Compatible avec variateur début et fin de phase
- En option, convertisseur dimmable DALI à commander séparément
- Fixation par ressorts

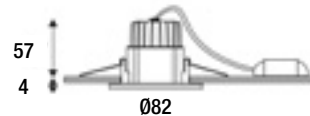

NEW

RÉF. ID	PUISSANCE	FLUX	T°	COULEUR	ENCASTREMENT MM	FORME	MATÉRIAU	PRIX HTVA
ID/03286955	9W	910 LM	3000°K	○ BLANC MAT	Ø 68	ROND	ALUMINIUM	€ 68,00
ID/03286953	9W	765 LM	3000°K	● NOIR MAT	Ø 68	ROND	ALUMINIUM	€ 68,00
ID/03286954	9W	910 LM	3000°K	● NICKEL SATINE	Ø 68	ROND	ALUMINIUM	€ 68,00
ID/03286958	9W	955 LM	4000°K	○ BLANC MAT	Ø 68	ROND	ALUMINIUM	€ 68,00
ID/03286956	9W	805 LM	4000°K	● NOIR MAT	Ø 68	ROND	ALUMINIUM	€ 68,00
ID/03286957	9W	955 LM	4000°K	● NICKEL SATINE	Ø 68	ROND	ALUMINIUM	€ 68,00
ID/03286961	9W	910 LM	3000°K	○ BLANC MAT	Ø 68	CARRÉ	ALUMINIUM	€ 68,00
ID/03286959	9W	765 LM	3000°K	● NOIR MAT	Ø 68	CARRÉ	ALUMINIUM	€ 68,00
ID/03286960	9W	910 LM	3000°K	● NICKEL SATINE	Ø 68	CARRÉ	ALUMINIUM	€ 68,00
ID/03286964	9W	955 LM	4000°K	○ BLANC MAT	Ø 68	CARRÉ	ALUMINIUM	€ 68,00
ID/03286962	9W	805 LM	4000°K	● NOIR MAT	Ø 68	CARRÉ	ALUMINIUM	€ 68,00
ID/03286963	9W	955 LM	4000°K	● NICKEL SATINE	Ø 68	CARRÉ	ALUMINIUM	€ 68,00

SPOTS ENCASTRÉS LED

TITAN FIX ROUND

LED 5 ANS IP20 40° IRC ≥90 TRIAC ↑ A++ A ⚡

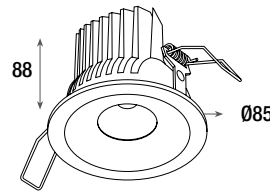

- Convertisseur dimmable par coupure de phase inclus
- Fixation par ressorts

RÉF. ID	PUISSANCE	FLUX	T°	COULEUR	ENCASTREMENT MM	PRIX HTVA
ID/02953790	8,9W	836 LM	2700°K	○ BLANC	Ø 76	€ 75,00
ID/02953792	8,9W	836 LM	2700°K	● NOIR	Ø 76	€ 75,00
ID/02953808	8,9W	867 LM	3000°K	○ BLANC	Ø 76	€ 75,00
ID/02953810	8,9W	867 LM	3000°K	● NOIR	Ø 76	€ 75,00
ID/02953826	8,9W	886 LM	4000°K	○ BLANC	Ø 76	€ 75,00
ID/02953828	8,9W	886 LM	4000°K	● NOIR	Ø 76	€ 75,00

TITAN MIX

LED 5 ANS IP20 40° IRC ≥90 TRIAC ↑ A++ A ⚡



- Convertisseur dimmable par coupure de phase inclus
- Fixation par ressorts

RÉF. ID	PUISSANCE	FLUX	T°	COULEUR	ENCASTREMENT MM	PRIX HTVA
ID/02955239	8,9W	836 LM	2700°K	○ BLANC	Ø 76	€ 89,00
ID/02955241	8,9W	836 LM	2700°K	● NOIR	Ø 76	€ 89,00
ID/02955259	8,9W	867 LM	3000°K	○ BLANC	Ø 76	€ 89,00
ID/02955261	8,9W	867 LM	3000°K	● NOIR	Ø 76	€ 89,00
ID/02955279	8,9W	886 LM	4000°K	○ BLANC	Ø 76	€ 89,00
ID/02955281	8,9W	886 LM	4000°K	● NOIR	Ø 76	€ 89,00

SPOTS ENCASTRÉS LED

GARI

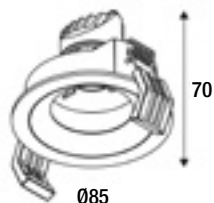

- Réflecteur basse luminosité
- Orientation de la source pour diffusion asymétrique
- Convertisseur dimmable par coupure de phase déporté inclus
- Fixation par ressorts

RÉF. ID	PUISSANCE	FLUX	T°	COULEUR	ENCASTREMENT MM	PRIX HTVA
ID/03126358	7W	423 LM	2700°K	○ BLANC	Ø 78	€ 72,00
ID/03126356	7W	423 LM	2700°K	● NOIR	Ø 78	€ 72,00
ID/03126362	7W	449 LM	3000°K	○ BLANC	Ø 78	€ 72,00
ID/03126360	7W	449 LM	3000°K	● NOIR	Ø 78	€ 72,00
ID/03126354	7W	519 LM	4000°K	○ BLANC	Ø 78	€ 72,00
ID/03126352	7W	519 LM	4000°K	● NOIR	Ø 78	€ 72,00

GARI TRIMLESS

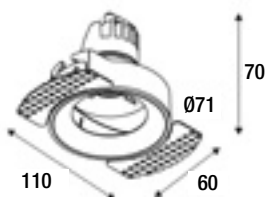

- Trimless (enduit de finition à réaliser)
- Kit d'encastrement inclus
- Réflecteur basse luminosité
- Orientation de la source pour diffusion asymétrique
- Convertisseur dimmable par coupure de phase déporté inclus

Le conseil de l'éclairagiste:

Pour une intégration parfaite de l'éclairage à l'architecture en matière de spots encastrés, dirigez-vous vers les versions trimless (sans bords). Effets garantis !

RÉF. ID	PUISSANCE	FLUX	T°	COULEUR	ENCASTREMENT MM	PRIX HTVA
ID/03126406	7W	423 LM	2700°K	○ BLANC	Ø 78	€ 76,00
ID/03126404	7W	423 LM	2700°K	● NOIR	Ø 78	€ 76,00
ID/03126410	7W	449 LM	3000°K	○ BLANC	Ø 78	€ 76,00
ID/03126408	7W	449 LM	3000°K	● NOIR	Ø 78	€ 76,00
ID/03126402	7W	519 LM	4000°K	○ BLANC	Ø 78	€ 76,00
ID/03126400	7W	519 LM	4000°K	● NOIR	Ø 78	€ 76,00

SPOTS ENCASTRÉS LED

GARI P



PUISSANCE X2

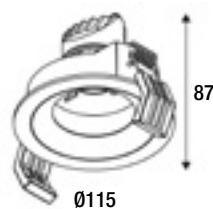

- Réflecteur basse luminance
- Orientation de la source pour diffusion asymétrique
- Convertisseur dimmable par coupure de phase déporté inclus
- Fixation par ressorts

RÉF. ID	PUISSANCE	FLUX	T°	COULEUR	ENCASTREMENT MM	PRIX HTVA
ID/03126514	13W	897 LM	2700°K	○ BLANC	Ø 100	€ 95,00
ID/03126512	13W	897 LM	2700°K	● NOIR	Ø 100	€ 95,00
ID/03126518	13W	944 LM	3000°K	○ BLANC	Ø 100	€ 95,00
ID/03126516	13W	944 LM	3000°K	● NOIR	Ø 100	€ 95,00
ID/03126510	13W	970 LM	4000°K	○ BLANC	Ø 100	€ 95,00
ID/03126508	13W	970 LM	4000°K	● NOIR	Ø 100	€ 95,00

GARI P TRIMLESS



PUISSANCE X2

SANS BORD

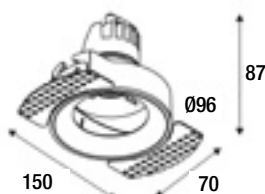

- Trimless (enduit de finition à réaliser)
- Kit d'encastrement inclus
- Réflecteur basse luminance
- Orientation de la source pour diffusion asymétrique
- Convertisseur dimmable par coupure de phase déporté inclus

RÉF. ID	PUISSANCE	FLUX	T°	COULEUR	ENCASTREMENT MM	PRIX HTVA
ID/03126586	13W	897 LM	2700°K	○ BLANC	Ø 100	€ 99,00
ID/03126584	13W	897 LM	2700°K	● NOIR	Ø 100	€ 99,00
ID/03126590	13W	944 LM	3000°K	○ BLANC	Ø 100	€ 99,00
ID/03126588	13W	944 LM	3000°K	● NOIR	Ø 100	€ 99,00
ID/03126582	13W	970 LM	4000°K	○ BLANC	Ø 100	€ 99,00
ID/03126580	13W	970 LM	4000°K	● NOIR	Ø 100	€ 99,00

SPOTS ENCASTRÉS LED

DUCA

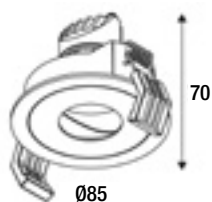

- Réflecteur basse luminance
- Anneau anti-éblouissement
- Orientation de la source pour diffusion asymétrique
- Convertisseur dimmable par coupure de phase déporté inclus
- Fixation par ressorts

RÉF. ID	PUISSANCE	FLUX	T°	COULEUR	ENCASTREMENT MM	PRIX HTVA
ID/03126382	7W	354 LM	2700°K	○ BLANC	Ø 78	€ 76,00
ID/03126380	7W	354 LM	2700°K	● NOIR	Ø 78	€ 76,00
ID/03126386	7W	393 LM	3000°K	○ BLANC	Ø 78	€ 76,00
ID/03126384	7W	393 LM	3000°K	● NOIR	Ø 78	€ 76,00
ID/03126378	7W	468 LM	4000°K	○ BLANC	Ø 78	€ 76,00
ID/03126376	7W	468 LM	4000°K	● NOIR	Ø 78	€ 76,00

DUCA TRIMLESS



SANS BORD

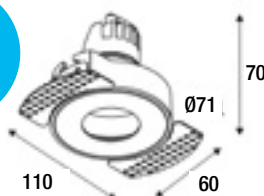

- Trimless (enduit de finition à réaliser)
- Kit d'encastrement inclus
- Réflecteur basse luminance
- Anneau anti-éblouissement
- Orientation de la source pour diffusion asymétrique
- Convertisseur dimmable par coupure de phase déporté inclus

RÉF. ID	PUISSANCE	FLUX	T°	COULEUR	ENCASTREMENT MM	PRIX HTVA
ID/03126430	7W	354 LM	2700°K	○ BLANC	Ø 78	€ 79,00
ID/03126428	7W	354 LM	2700°K	● NOIR	Ø 78	€ 79,00
ID/03126434	7W	393 LM	3000°K	○ BLANC	Ø 78	€ 79,00
ID/03126432	7W	393 LM	3000°K	● NOIR	Ø 78	€ 79,00
ID/03126426	7W	468 LM	4000°K	○ BLANC	Ø 78	€ 79,00
ID/03126424	7W	468 LM	4000°K	● NOIR	Ø 78	€ 79,00

SPOTS ENCASTRÉS LED

DUCA P



PUISSANCE X2

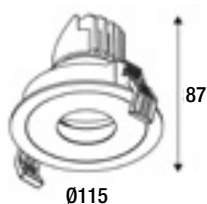

- Réflecteur basse luminance
- Anneau anti-éblouissement
- Orientation de la source pour diffusion asymétrique
- Convertisseur dimmable par coupure de phase déporté inclus
- Fixation par ressorts

RÉF. ID	PUISSANCE	FLUX	T°	COULEUR	ENCASTREMENT MM	PRIX HTVA
ID/03126550	13W	534 LM	2700°K	○ BLANC	Ø 100	€ 102,00
ID/03126548	13W	534 LM	2700°K	● NOIR	Ø 100	€ 102,00
ID/03126554	13W	646 LM	3000°K	○ BLANC	Ø 100	€ 102,00
ID/03126552	13W	646 LM	3000°K	● NOIR	Ø 100	€ 102,00
ID/03126546	13W	657 LM	4000°K	○ BLANC	Ø 100	€ 102,00
ID/03126544	13W	657 LM	4000°K	● NOIR	Ø 100	€ 102,00

DUCA P TRIMLESS



PUISSANCE X2

SANS BORD

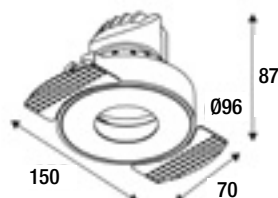

- Trimless (enduit de finition à réaliser)
- Kit d'encastrement inclus
- Réflecteur basse luminance
- Anneau anti-éblouissement
- Orientation de la source pour diffusion asymétrique
- Convertisseur dimmable par coupure de phase déporté inclus

RÉF. ID	PUISSANCE	FLUX	T°	COULEUR	ENCASTREMENT MM	PRIX HTVA
ID/03126622	13W	534 LM	2700°K	○ BLANC	Ø 100	€ 105,00
ID/03126620	13W	534 LM	2700°K	● NOIR	Ø 100	€ 105,00
ID/03126626	13W	646 LM	3000°K	○ BLANC	Ø 100	€ 105,00
ID/03126624	13W	646 LM	3000°K	● NOIR	Ø 100	€ 105,00
ID/03126618	13W	657 LM	4000°K	○ BLANC	Ø 100	€ 105,00
ID/03126616	13W	657 LM	4000°K	● NOIR	Ø 100	€ 105,00

SPOTS ENCASTRÉS LED

LENA

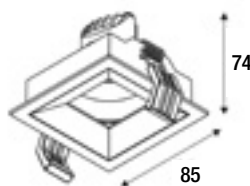

- Réflecteur basse luminance
- Cadre anti-éblouissement
- Orientation de la source pour diffusion asymétrique
- Convertisseur dimmable par coupure de phase déporté inclus
- Fixation par ressorts

RÉF. ID	PUISSANCE	FLUX	T°	COULEUR	ENCASTREMENT MM	PRIX HTVA
ID/03126454	7W	372 LM	2700°K	○ BLANC	78 X 78	€ 76,00
ID/03126452	7W	372 LM	2700°K	● NOIR	78 X 78	€ 76,00
ID/03126458	7W	417 LM	3000°K	○ BLANC	78 X 78	€ 76,00
ID/03126456	7W	417 LM	3000°K	● NOIR	78 X 78	€ 76,00
ID/03126450	7W	495 LM	4000°K	○ BLANC	78 X 78	€ 76,00
ID/03126448	7W	495 LM	4000°K	● NOIR	78 X 78	€ 76,00

LENA TRIMLESS



SANS BORD

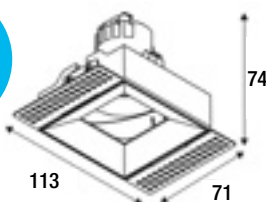

- Trimless (enduit de finition à réaliser)
- Kit d'encastrement inclus
- Réflecteur basse luminance
- Cadre anti-éblouissement
- Orientation de la source pour diffusion asymétrique
- Convertisseur dimmable par coupure de phase déporté inclus

RÉF. ID	PUISSANCE	FLUX	T°	COULEUR	ENCASTREMENT MM	PRIX HTVA
ID/03126478	7W	372 LM	2700°K	○ BLANC	78 X 72	€ 79,00
ID/03126476	7W	372 LM	2700°K	● NOIR	78 X 72	€ 79,00
ID/03126482	7W	417 LM	3000°K	○ BLANC	78 X 72	€ 79,00
ID/03126480	7W	417 LM	3000°K	● NOIR	78 X 72	€ 79,00
ID/03126474	7W	495 LM	4000°K	○ BLANC	78 X 72	€ 79,00
ID/03126472	7W	495 LM	4000°K	● NOIR	78 X 72	€ 79,00

SPOTS ENCASTRÉS LED

LENA P

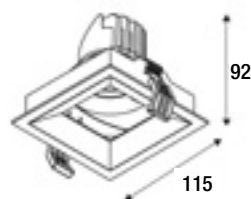

- Réflecteur basse luminance
- Cadre anti-éblouissement
- Orientation de la source pour diffusion asymétrique
- Convertisseur dimmable par coupure de phase déporté inclus
- Fixation par ressorts

RÉF. ID	PUISSANCE	FLUX	T°	COULEUR	ENCASTREMENT MM	PRIX HTVA
ID/03126658	13W	688 LM	2700°K	○ BLANC	102 X 102	€ 99,00
ID/03126656	13W	688 LM	2700°K	● NOIR	102 X 102	€ 99,00
ID/03126662	13W	862 LM	3000°K	○ BLANC	102 X 102	€ 99,00
ID/03126660	13W	862 LM	3000°K	● NOIR	102 X 102	€ 99,00
ID/03126654	13W	887 LM	4000°K	○ BLANC	102 X 102	€ 99,00
ID/03126652	13W	887 LM	4000°K	● NOIR	102 X 102	€ 99,00

LENA P TRIMLESS

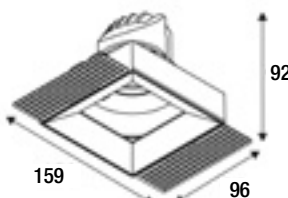

- Trimless (enduit de finition à réaliser)
- Kit d'encastrement inclus
- Réflecteur basse luminance
- Cadre anti-éblouissement
- Orientation de la source pour diffusion asymétrique
- Convertisseur dimmable par coupure de phase déporté inclus

RÉF. ID	PUISSANCE	FLUX	T°	COULEUR	ENCASTREMENT MM	PRIX HTVA
ID/03126694	13W	688 LM	2700°K	○ BLANC	104 X 97	€ 102,00
ID/03126692	13W	688 LM	2700°K	● NOIR	104 X 97	€ 102,00
ID/03126698	13W	862 LM	3000°K	○ BLANC	104 X 97	€ 102,00
ID/03126696	13W	862 LM	3000°K	● NOIR	104 X 97	€ 102,00
ID/03126690	13W	887 LM	4000°K	○ BLANC	104 X 97	€ 102,00
ID/03126688	13W	887 LM	4000°K	● NOIR	104 X 97	€ 102,00

MINI SPOTS ENCASTRÉS LED

LISY RD



- Mini spot encastré rond fixe
- Réflecteur basse luminance
- Convertisseur dimmable déporté fourni
- Compatible avec variateur début et fin de phase
- Fixation par ressorts

NEW

RÉF. ID	PUISSANCE	FLUX	T°	COULEUR	ENCASTREMENT MM	MATÉRIAU	PRIX HTVA
ID/03382835	4,5W	440 LM	3000°K	○ BLANC MAT	Ø 45	ALUMINIUM	€ 49,00
ID/03382834	4,5W	440 LM	3000°K	● NOIR MAT	Ø 45	ALUMINIUM	€ 49,00

LISY RDX



- Mini spot encastré rond orientable
- Réflecteur basse luminance
- Convertisseur dimmable déporté fourni
- Compatible avec variateur début et fin de phase
- Fixation par ressorts

NEW

RÉF. ID	PUISSANCE	FLUX	T°	COULEUR	ENCASTREMENT MM	MATÉRIAU	PRIX HTVA
ID/03382837	4.5W	474 LM	3000°K	○ BLANC MAT	Ø 58	ALUMINIUM	€ 49,00
ID/03382836	4.5W	474 LM	3000°K	● NOIR MAT	Ø 58	ALUMINIUM	€ 49,00



MINI SPOTS ENCASTRÉS LED

TIBLI R-B



SPOTS ENCASTRÉS

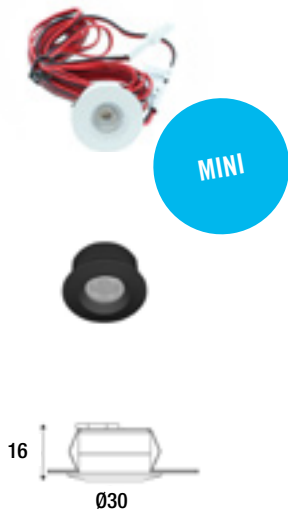

- Mini spot encastré rond fixe
- Précâblé 2.00m
- Convertisseur 350mA à commander séparément. (min. 2W max. 4W) voir p. 446
- Fixation par lamelles

Le conseil de l'éclairagiste:

Pour éclairer et donc mettre en valeur une étagère, une bibliothèque ou encore un plan de travail au départ des meubles hauts de cuisine... choisissez des luminaires spécifiques avec une faible profondeur d'encastrement. Ils s'inséreront plus facilement dans des matériaux comme le bois, tout en ayant une faible incidence sur la solidité de ceux-ci.

NEW

RÉF. ID	PUISSANCE	FLUX	T°	COULEUR	ENCASTREMENT MM	MATÉRIAU	PRIX HTVA
ID/03382861	1,2W	115 LM	3000°K	○ BLANC MAT	Ø 25	ALUMINIUM	€ 25,00
ID/03382860	1,2W	115 LM	3000°K	● NOIR MAT	Ø 25	ALUMINIUM	€ 25,00



MINI SPOTS ENCASTRÉS LED

ANKARA



62



23

36

- Convertisseur non dimmable inclus
- Fixation par ressorts

RÉF. ID	PUISSANCE	FLUX	T°	COULEUR	ENCASTREMENT MM	PRIX HTVA
ID/01736067	5W	360 LM	3000°K	○ BLANC	Ø 43	€ 26,00
ID/03174671	5W	360 LM	3000°K	● NOIR	Ø 43	€ 26,00
ID/02204695	5W	360 LM	3000°K	● ALU	Ø 43	€ 26,00
ID/01736068	5W	360 LM	4000°K	○ BLANC	Ø 43	€ 26,00
ID/03174672	5W	360 LM	4000°K	● NOIR	Ø 43	€ 26,00
ID/02204696	5W	360 LM	4000°K	● ALU	Ø 43	€ 26,00

SPOTI R-B

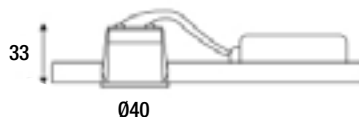

- Spot précâblé 1.50m au convertisseur
- Double bornier automatique
- Convertisseur non dimmable déporté inclus
- Fixation par lamelles

RÉF. ID	PUISSANCE	FLUX	T°	COULEUR	ENCASTREMENT MM	PRIX HTVA
ID/02223573	4,5W	445 LM	3000°K	○ BLANC	Ø 35	€ 45,00
ID/02223574	4,5W	365 LM	3000°K	● ANTHRACITE	Ø 35	€ 45,00
ID/02510225	4,5W	445 LM	3000°K	● ALU	Ø 35	€ 45,00
ID/02223571	4,5W	450 LM	4000°K	○ BLANC	Ø 35	€ 45,00
ID/02223572	4,5W	375 LM	4000°K	● ANTHRACITE	Ø 35	€ 45,00
ID/02510226	4,5W	450 LM	4000°K	● ALU	Ø 35	€ 45,00



SPOTS SEMI ENCASTRÉS LED

KUANA S



- Anneau de finition apparent d'une hauteur de 30mm
- Réflecteur garantissant un éclairage non éblouissant, homogène et diffus
- Nécessite un driver en courant constant de 500mA (voir p. 447)
- Positionnement affleurant avec anneau d'encastrement en option
- Fixation par ressorts

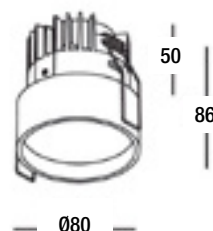

NEW

RÉF. ID	PUISSANCE	FLUX	T°	COULEUR	ENCASTREMENT MM	MATÉRIAU	PRIX HTVA
ID/03468527	9W	1000 LM	2700°K	○ BLANC	Ø 68	ALUMINIUM	€ 50,00
ID/03468525	9W	1000 LM	2700°K	● CHAMPAGNE	Ø 68	ALUMINIUM	€ 50,00
ID/03468523	9W	1000 LM	2700°K	● NOIR	Ø 68	ALUMINIUM	€ 50,00
ID/03468528	9W	1000 LM	3000°K	○ BLANC	Ø 68	ALUMINIUM	€ 50,00
ID/03468526	9W	1000 LM	3000°K	● CHAMPAGNE	Ø 68	ALUMINIUM	€ 50,00
ID/03468524	9W	1000 LM	3000°K	● NOIR	Ø 68	ALUMINIUM	€ 50,00

RÉF. ID	ACCESSOIRES EN OPTION		PRIX HTVA
ID/03473225		ANNEAU D'ENCASTREMENT Ø89 BLANC	€ 10,00
ID/03473222		ANNEAU D'ENCASTREMENT Ø89 CHAMPAGNE	€ 10,00
ID/03473221		ANNEAU D'ENCASTREMENT Ø89 NOIR	€ 10,00
ID/03473223		KIT D'ENCASTREMENT PLAFONDS BETON	€ 5,00
ID/03473224		KIT D'ENCASTREMENT TRIMLESS Ø86	€ 17,50

SPOTS SEMI ENCASTRÉS LED

SYLA-B

LED

3
ANS

IP23

38°

IRC
>90



A++
A



SPOTS ENCASTRÉS



- Réflecteur basse luminance
- Convertisseur 250mA non dimmable déporté inclus
- Convertisseur 250mA dimmable DALI sur demande
- Fixation par lamelles

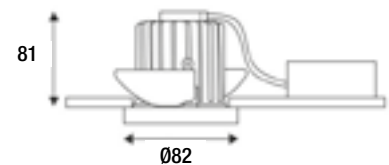

RÉF. ID	PUISSANCE	FLUX	T°	COULEUR	ENCASTREMENT MM	MATÉRIAU	PRIX HTVA
ID/02223535	10W	851 LM	3000°K	○ BLANC MAT	Ø 75	ALUMINIUM	€ 75,00
ID/02223533	10W	851 LM	3000°K	● NOIR MAT	Ø 75	ALUMINIUM	€ 75,00
ID/02223534	10W	851 LM	3000°K	● NOIR/DORÉ ●	Ø 75	ALUMINIUM	€ 90,00



SPOTS SEMI ENCASTRÉS LED

STRASBOURG MICRO

LED

3
ANS



90°

30°

IRC
>80



A++

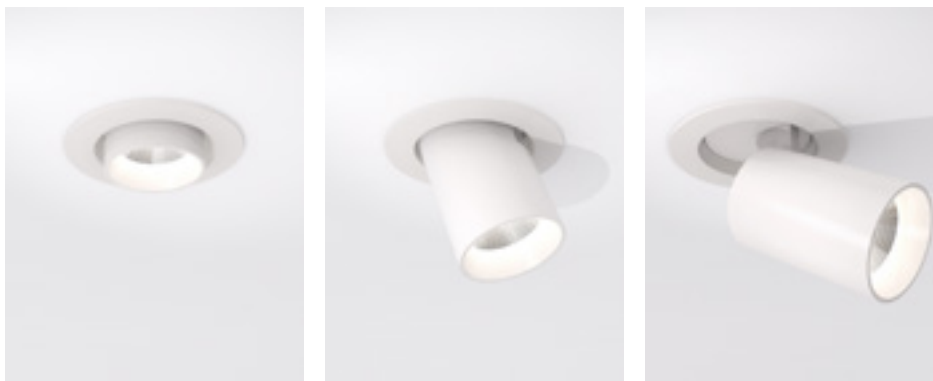

- Bague blanche incluse avec spot blanc
- Bague noire incluse avec spot noir
- Convertisseurs dimmables 700mA (voir p.448)
- Fixation lamelles

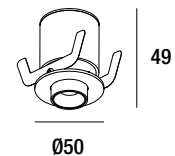

Le conseil de l'éclairagiste:

Les spots semi-encastrés sont hyper-tendance et on comprend pourquoi. Discrets quand ils sont repliés dans le plafond, fonctionnels et stylés une fois sortis et orientés, ils combinent certains avantages de l'encastré et de l'apparent, les rendant ainsi très polyvalents.

RÉF. ID	PUISSANCE	FLUX	T°	COULEUR	ENCASTREMENT MM	PRIX HTVA
ID/02628649	2W	240 LM	2700°K	○ BLANC MAT	Ø 44	€ 50,00
ID/02628651	2W	240 LM	2700°K	● NOIR MAT	Ø 44	€ 50,00
ID/02628650	2W	250 LM	3000°K	○ BLANC MAT	Ø 44	€ 50,00
ID/02628652	2W	250 LM	3000°K	● NOIR MAT	Ø 44	€ 50,00
ID/02628653		BAGUE DE FINITION ○ BLANCHE				€ 2,70
ID/02628654		BAGUE DE FINITION ● NOIRE				€ 2,70
ID/02628655		BAGUE DE FINITION ● ARGENTÉE				€ 2,70
ID/02628656		BAGUE DE FINITION ● DOREE				€ 2,70

SPOTS SEMI ENCASTRÉS LED

STRASBOURG MINI

LED 3 ANS IP20 40° 48° IRC >80 A++

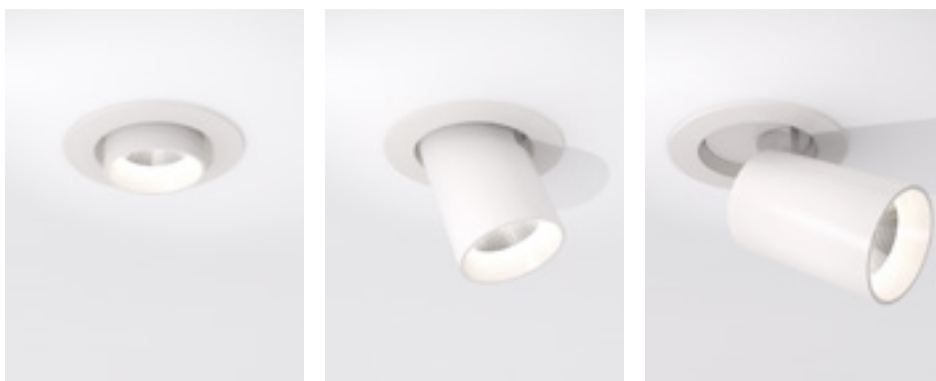

- Bague blanche incluse avec spot blanc
- Bague noire incluse avec spot noir
- Convertisseurs dimmables 350mA (voir p. 446)
- Fixation lamelles

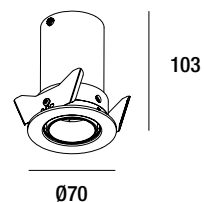

RÉF. ID	PUISSANCE	FLUX	T°	COULEUR	ENCASTREMENT MM	PRIX HTVA
ID/02517911	6,2W	665 LM	2700°K	○ BLANC MAT	Ø 64	€ 74,00
ID/02517913	6,2W	665 LM	2700°K	● NOIR MAT	Ø 64	€ 74,00
ID/02517912	6,2W	700 LM	3000°K	○ BLANC MAT	Ø 64	€ 74,00
ID/02517914	6,2W	700 LM	3000°K	● NOIR MAT	Ø 64	€ 74,00
ID/02517915		BAGUE DE FINITION ○ BLANCHE				€ 4,90
ID/02517916		BAGUE DE FINITION ● NOIRE				€ 4,90
ID/02517917		BAGUE DE FINITION ● ARGENTEE				€ 4,90
ID/02517918		BAGUE DE FINITION ● DOREE				€ 4,90

SPOTS SEMI ENCASTRÉS LED

STRASBOURG

LED

3
ANS

IP20

90°

48°

IRC
>80



A+



SPOTS ENCASTRÉS

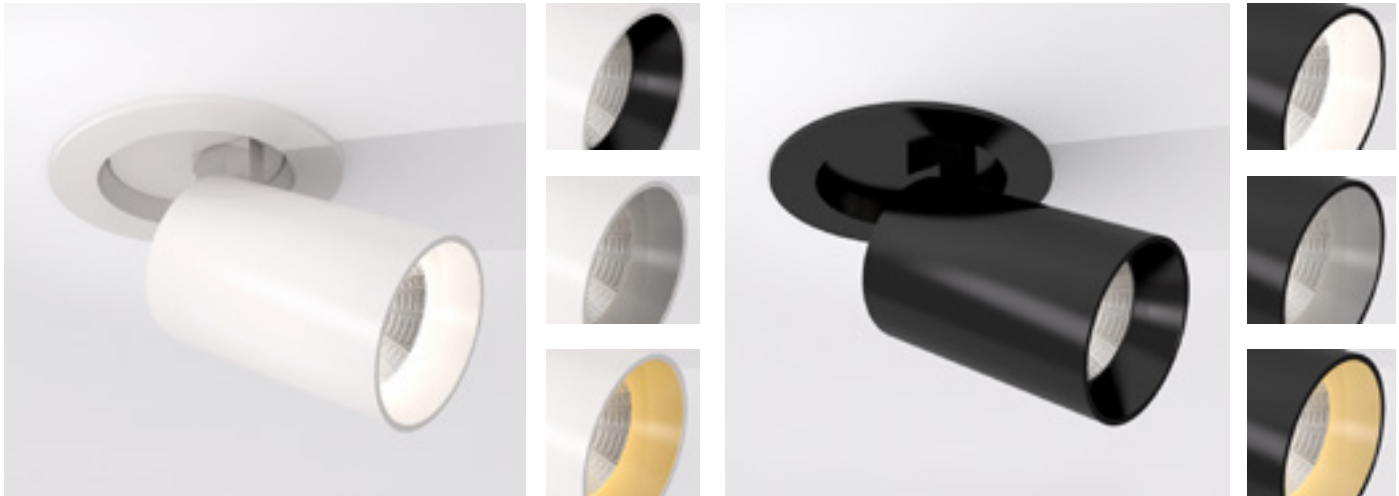

- Bague blanche incluse avec spot blanc
- Bague noire incluse avec spot noir
- Convertisseurs dimmables 500mA (voir p. 446)
- Fixation ressorts

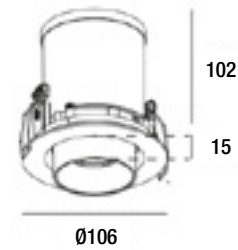

RÉF. ID	PUISSANCE	FLUX	T°	COULEUR	ENCASTREMENT MM	PRIX HTVA
ID/02204597	9,2W	890 LM	2700°K	○ BLANC MAT	Ø 89	€ 91,00
ID/02204599	9,2W	890 LM	2700°K	● NOIR MAT	Ø 89	€ 91,00
ID/02204598	9,2W	945 LM	3000°K	○ BLANC MAT	Ø 89	€ 91,00
ID/02204600	9,2W	945 LM	3000°K	● NOIR MAT	Ø 89	€ 91,00
ID/02204601		BAGUE DE FINITION ○ BLANCHE				€ 4,90
ID/02204602		BAGUE DE FINITION ● NOIRE				€ 4,90
ID/02204603		BAGUE DE FINITION ● ARGENTÉE				€ 4,90
ID/02204604		BAGUE DE FINITION ● DORÉE				€ 4,90

SPOTS SEMI ENCASTRÉS LED

KARTY

LED 3 ANS IP20 45° 38° IRC >90 TRIAC ↑ A++ A ⚡ 🏠

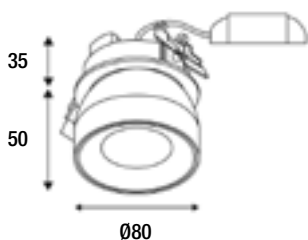

- Réflecteur basse luminance
- Convertisseur dimmable Triac déporté inclus
- Fixation par ressorts

RÉF. ID	PUISSANCE	FLUX	T°	COULEUR	ENCASTREMENT MM	PRIX HTVA
ID/02682350	8W	595 LM	3000°K	○ BLANC MAT	Ø 73	€ 120,00
ID/02682349	8W	595 LM	3000°K	● NOIR MAT	Ø 73	€ 120,00

MINI CLIC

LED 3 ANS IP20 90° 38° IRC >90 TRIAC ↑ A++ A ⚡ 🏠

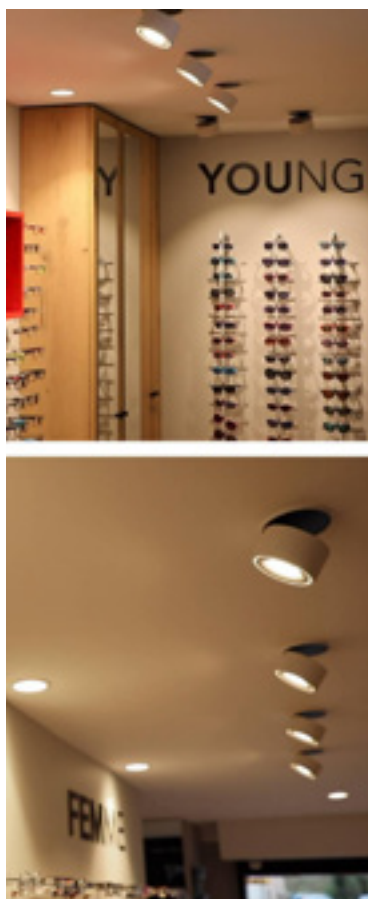

- Convertisseur dimmable Triac déporté inclus
- Fixation par ressorts



RÉF. ID	PUISSANCE	FLUX	T°	COULEUR	ENCASTREMENT MM	PRIX HTVA
ID/02786393	8W	470 LM	3000°K	○ BLANC MAT	Ø 68	€ 90,00
ID/02786392	8W	470 LM	3000°K	● NOIR MAT	Ø 68	€ 90,00



DOWNLIGHTS TERTIAIRE/RETAIL

PAGES 82 À 93

Avec pour vocation de mettre en lumière des espaces de travail, magasins et autres activités professionnelles avec des durées d'allumage conséquentes, les downlights sont spécialement conçus pour une fiabilité et une efficacité maximale.



DOWNLIGHTS RÉSIDENTIEL



HIDE
84

NEW



WIDE
84

DOWNLIGHTS TERTIAIRE/RETAIL



EASY
86



LOS ANGELES 7
86



LOS ANGELES 14
87



LOS ANGELES 25
87



PANAMA 4
88



PANAMA 6
89



PANAMA 8
89



PANAMA 8 HR
89



SAN DIEGO
90



SIRA R
90



NEW

OMAC
91



NEW

FOCEA
91



COURCHEVEL
92



NEW

SPIRA 1 RX
93



NEW

SPIRA 3
93

DOWNLIGHTS RÉSIDENTIEL

DOWNLIGHTS TERTIAIRE/RETAIL

HIDE



- Diffuseur en verre
- Convertisseur non dimmable déporté inclus
- Fixation ressorts

FAIBLE ENCOMBREMENT
SUPER FLUX

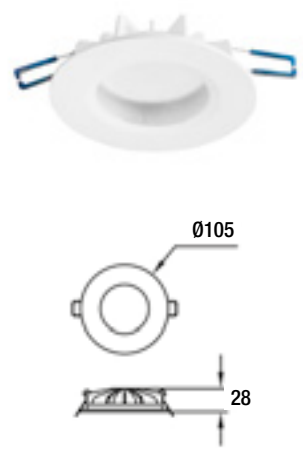

RÉF. ID	PUISSANCE	FLUX	T°	COULEUR	ENCASTREMENT MM	MATÉRIAU	PRIX HTVA
ID/02257551	9W	1150 LM	3000°K	○ BLANC	Ø 92	ALUMINIUM	€ 35,00

WIDE



- Downlight sans cadre pour un éclairage beaucoup plus large
- Convertisseur non dimmable déporté inclus
- Fixation ressorts

NEW

RÉF. ID	PUISSANCE	FLUX	T°	COULEUR	DIAMETRE MM	ENCASTREMENT MM	MATÉRIAU	PRIX HTVA
ID/03328654	8,5W	803 LM	3000°K	○ OPALIN	Ø 90	Ø 70	ALUMINIUM/POLYCARBON	€ 20,00
ID/03328655	8,5W	803 LM	4000°K	○ OPALIN	Ø 90	Ø 70	ALUMINIUM/POLYCARBON	€ 20,00
ID/03328656	16,2W	1270 LM	3000°K	○ OPALIN	Ø 120	Ø 108	ALUMINIUM/POLYCARBON	€ 29,00
ID/03328657	16,2W	1270 LM	4000°K	○ OPALIN	Ø 120	Ø 108	ALUMINIUM/POLYCARBON	€ 29,00



DOWNLIGHTS TERTIAIRE

EASY

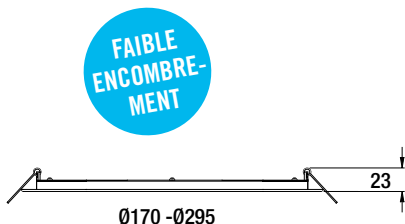

- Corps en aluminium
- Diffuseur en acrylique opalin
- Convertisseur non dimmable déporté inclus
- Fixation par ressorts

RÉF. ID	PUISSANCE	FLUX	T°	COULEUR	DIAMETRE MM	ENCASTREMENT MM	PRIX HTVA
ID/02257535	10W	1150 LM	3000°K	○ BLANC	Ø 170	Ø 158	€ 25,00
ID/02257536	10W	1150 LM	4000°K	○ BLANC	Ø 170	Ø 158	€ 25,00
ID/02257537	15,5W	1510 LM	3000°K	○ BLANC	Ø 225	Ø 205	€ 35,00
ID/02257538	15,5W	1510 LM	4000°K	○ BLANC	Ø 225	Ø 205	€ 35,00
ID/02289093	19,7W	2160 LM	3000°K	○ BLANC	Ø 295	Ø 280	€ 49,00
ID/02289094	19,7W	2160 LM	4000°K	○ BLANC	Ø 295	Ø 280	€ 49,00

LOS ANGELES 7

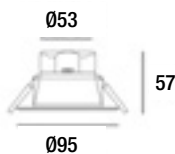

- Boîtier de connexion rapide, double raccordement
- Fixation par ressorts

RÉF. ID	PUISSANCE	FLUX	T°	COULEUR	ENCASTREMENT MM	PRIX HTVA
ID/01917100	7W	560LM	3000°K	○ BLANC	Ø 70	€ 17,30
ID/02122186	7W	560 LM	4000°K	○ BLANC	Ø 70	€ 17,30

DOWNLIGHTS TERTIAIRE

LOS ANGELES 14

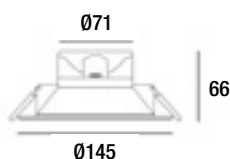

- Boitier de connexion rapide, double raccordement
- Bague inox à fixer
- Fixation par ressorts

RÉF. ID	PUISSANCE	FLUX	T°	COULEUR	ENCASTREMENT MM	PRIX HTVA
ID/01917101	14W	1300 LM	3000°K	○ BLANC	Ø 125	€ 28,00
ID/02122187	14W	1400 LM	4000°K	○ BLANC	Ø 125	€ 28,00
ID/02517947	14W	1300 LM	3000°K	● INOX	Ø 125	€ 33,00
ID/02517948	14W	1400 LM	4000°K	● INOX	Ø 125	€ 33,00

LOS ANGELES 25

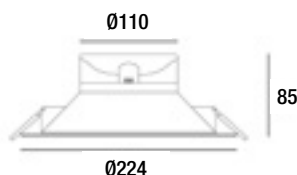

- Boitier de connexion rapide, double raccordement
- Bague inox à fixer
- Fixation par ressorts

RÉF. ID	PUISSANCE	FLUX	T°	COULEUR	ENCASTREMENT MM	PRIX HTVA
ID/02122188	25W	2420 LM	3000°K	○ BLANC	Ø 205	€ 48,00
ID/01917102	25W	2450 LM	4000°K	○ BLANC	Ø 205	€ 48,00
ID/02204708	25W	2420 LM	3000°K	● INOX	Ø 205	€ 52,00
ID/02204709	25W	2450 LM	4000°K	● INOX	Ø 205	€ 52,00

DOWNLIGHTS TERTIAIRE

PANAMA 4



- Fixation par ressorts

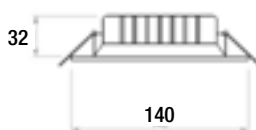

RÉF. ID	PUISSANCE	FLUX	T°	COULEUR	ENCASTREMENT MM	PRIX HTVA
ID/03468592	11W	900 LM	3000°K	○ BLANC	Ø 110	€ 24,00
ID/03468591	11W	1000 LM	4000°K	○ BLANC	Ø 110	€ 24,00
ID/03468565	DRIVER DIMMABLE PAR COUPURE DE PHASE 11W					€ 13,00
ID/03468467	DRIVER DIMMABLE DALI 20W					€ 74,00

PANAMA 6



- Fixation par ressorts

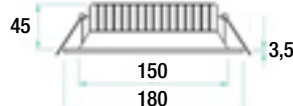
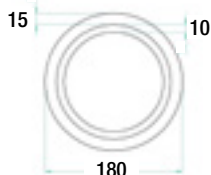

RÉF. ID	PUISSANCE	FLUX	T°	COULEUR	ENCASTREMENT MM	PRIX HTVA
ID/03468618	15W	1350 LM	3000°K	○ BLANC	Ø 150	€ 32,00
ID/03468617	15W	1500 LM	4000°K	○ BLANC	Ø 150	€ 32,00
ID/03468566	DRIVER DIMMABLE PAR COUPURE DE PHASE 15W					€ 16,00
ID/03468467	DRIVER DIMMABLE DALI 20W					€ 74,00

DOWNLIGHTS TERTIAIRE

PANAMA 8

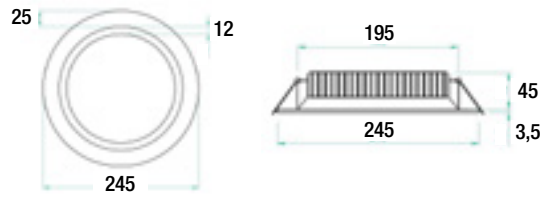

- Fixation par ressorts

RÉF. ID	PUISSANCE	FLUX	T°	COULEUR	ENCASTREMENT MM	PRIX HTVA
ID/03468646	20W	1800 LM	3000°K	○ BLANC	Ø 200	€ 40,00
ID/03468645	20W	2000 LM	4000°K	○ BLANC	Ø 200	€ 40,00
ID/03468567	DRIVER DIMMABLE PAR COUPURE DE PHASE 20W					€ 16,00
ID/02646176	DRIVER DIMMABLE DALI 40W					€ 74,00

PANAMA 8 HR

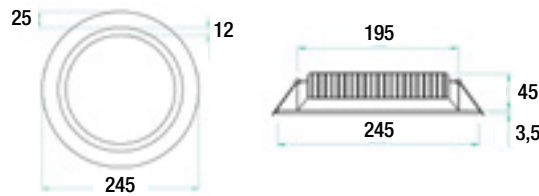
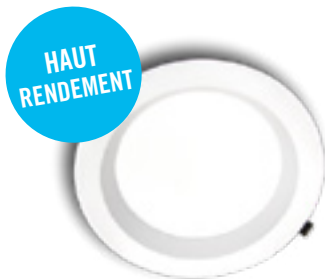

- Fixation par ressorts

RÉF. ID	PUISSANCE	FLUX	T°	COULEUR	ENCASTREMENT MM	PRIX HTVA
ID/03468648	30W	2700 LM	3000°K	○ BLANC	Ø 200	€ 50,00
ID/03468647	30W	3000 LM	4000°K	○ BLANC	Ø 200	€ 50,00
ID/03468568	DRIVER DIMMABLE PAR COUPURE DE PHASE 30W					€ 18,00
ID/03546421	DRIVER DIMMABLE 1-10V 42W					€ 21,00
ID/02646176	DRIVER DIMMABLE DALI 40W					€ 74,00

DOWNLIGHTS TERTIAIRE

SAN DIEGO



3 TEINTES DE LUMIÈRE

Possibilité de passer du 3000°K au 4000°K et 6000°K via un switch situé sur le dessus de l'appareil

3000K 4000K 6000K

- Fixation par ressorts
- Boîtier de connexion rapide, double raccordement
- Convertisseur non dimmable inclus
- Convertisseur dimmable voir p.448

RÉF. ID	PUISSANCE	AMPÉRAGE	FLUX	T°	COULEUR	DIAMÈTRE MM	ENCASTREMENT MM	PRIX HTVA
ID/02517949	10W	700mA	650 - 850 LM	3000-6000 °K	○ BLANC	Ø 113	Ø 90	€ 29,00
ID/02517950	14W	700mA	990 - 1190 LM	3000-6000 °K	○ BLANC	Ø 143	Ø 117	€ 32,00
ID/02517951	20W	700mA	1520 - 1720 LM	3000-6000 °K	○ BLANC	Ø 200	Ø 168	€ 45,00
ID/02517952	30W	700mA	2620 - 2820 LM	3000-6000 °K	○ BLANC	Ø 230	Ø 192	€ 55,00
ID/02517953	40W	1050mA	3680 - 3880 LM	3000-6000 °K	○ BLANC	Ø 279	Ø 240	€ 67,00

SIRA R



3 TEINTES DE LUMIÈRE

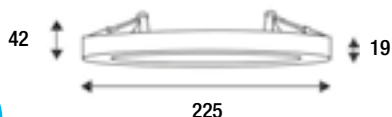

- Montage apparent ou semi-encastré.
- 3000K, 4000K ou 6000K au choix via un switch à l'arrière du luminaire.
- Fixation par ressorts ajustables pour couvrir les diamètres d'encastrement de 65 à 180mm.

RÉF. ID	PUISSANCE	FLUX	T°	COULEUR	ENCASTREMENT MM	PRIX HTVA
ID/02786394	18W	1500 LM	3000-6000 °K	○ BLANC	Ø 65 - 180	€ 50,00

DOWNLIGHTS TERTIAIRE

OMAC



UGR <19

- Convertisseur non dimmable déporté inclus
- Connecteur rapide double raccordement
- Dimmable sur demande
- Livré avec collerette blanche Ø230
- Fixation par ressorts

NEW

RÉF. ID	PUISSANCE	FLUX	T°	COULEUR	ENCASTREMENT MM	PRIX HTVA
ID/02846145	19W	2000 LM	4000°K	○ BLANC	Ø 190 - 210	€ 61,00
ID/03546859		COLLERETTE Ø 230MM NOIR (OPTION)				€ 8,20
ID/03546860		COLLERETTE Ø 285MM BLANC (OPTION)				€ 12,00
ID/03546968		DRIVER 50W ZIGBEE (OPTION)				€ 105,00

FOCEA



- Verre de protection
- Convertisseur non dimmable déporté inclus
- Fixation par ressorts

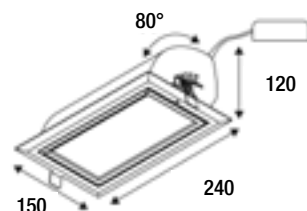

Le conseil de l'éclairagiste:

Idéal pour l'éclairage de vitrines de magasins ou rayonnages nécessitant un flux intense.

NEW

RÉF. ID	PUISSANCE	FLUX	T°	COULEUR	ENCASTREMENT MM	PRIX HTVA
ID/03382781	40W	4287 LM	3000°K	○ BLANC	135 X 225	€ 190,00
ID/02682354	40W	5260 LM	4000°K	○ BLANC	135 X 225	€ 190,00
ID/02682355	60W	8680 LM	4000°K	○ BLANC	135 X 225	€ 290,00

DOWNLIGHTS TERTIAIRE

COURCHEVEL

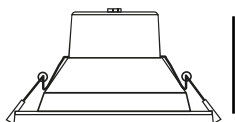

66 / 80
90 / 118

Ø113 / Ø145
Ø174 / Ø232

- Boitier de connexion rapide, double raccordement
- Convertisseur non dimmable inclus
- Convertisseur dimmable (voir p.446 &p.448)
- Fixation par ressorts

Le conseil de l'éclairagiste:

Le boitier de connexion rapide à double raccordement, c'est un gain de temps et de matériel... et donc un gain d'argent. Pensez-y dans le choix de vos luminaires !

RÉF. ID	PUISSANCE	AMPÉRAGE	FLUX	T°	COULEUR	DIAMETRE MM	ENCASTREMENT MM	PRIX HTVA
ID/02628633	10W	350mA	800 LM	3000°K	○BLANC	Ø 113	Ø 90	€ 36,00
ID/02628634	10W	350mA	880 LM	4000°K	○BLANC	Ø 113	Ø 90	€ 36,00
ID/02628635	15W	700mA	1200LM	3000°K	○BLANC	Ø 145	Ø 120	€ 39,00
ID/02628636	15W	700mA	1320LM	4000°K	○BLANC	Ø 145	Ø 120	€ 39,00
ID/02628637	20W	700mA	1640LM	3000°K	○BLANC	Ø 174	Ø 145	€ 47,00
ID/02628638	20W	700mA	1800LM	4000°K	○BLANC	Ø 174	Ø 145	€ 47,00
ID/02628639	28W	700mA	2300LM	3000°K	○BLANC	Ø 232	Ø 195	€ 57,00
ID/02628640	28W	700mA	2500LM	4000°K	○BLANC	Ø 232	Ø 195	€ 57,00
ID/02628641	30W	700mA	2870LM	3000°K	○BLANC	Ø 232	Ø 195	€ 59,00
ID/02628642	30W	700mA	3150LM	4000°K	○BLANC	Ø 232	Ø 195	€ 59,00



SPIRA 1 RX

LED 3 ANS IP23 80° 40° IRC 80

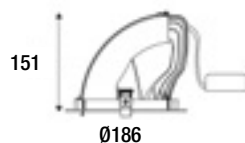

- Verre de protection
- Convertisseur non dimmable déporté inclus
- Fixation par ressorts

NEW

RÉF. ID	PUISSANCE	FLUX	T°	COULEUR	ENCASTREMENT MM	MATÉRIAU	PRIX HTVA
ID/03382780	40W	3267 LM	3000°K	○ BLANC	Ø 175	ALUMINIUM	€ 160,00
ID/02682353	40W	4055 LM	4000°K	○ BLANC	Ø 175	ALUMINIUM	€ 160,00

SPIRA 3

LED 3 ANS IP23 80° 40° IRC 80



TRÈS HAUT RENDEMENT

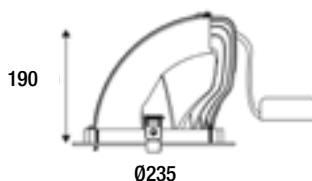

- Verre de protection
- Convertisseur non dimmable déporté inclus
- Fixation par ressorts

NEW

RÉF. ID	PUISSANCE	FLUX	T°	COULEUR	ENCASTREMENT MM	MATÉRIAU	PRIX HTVA
ID/02682522	60W	7124 LM	4000°K	○ BLANC	Ø 215	ALUMINIUM	€ 290,00



LED PANELS

PAGES 94 À 99

Conçus pour s'intégrer dans les faux-plafonds modulaires, les Led panels offrent un excellent rendement lumineux associé à un bon confort visuel; deux caractéristiques essentielles dans des espaces de bureaux par exemple.



LED PANELS



PANEL
96



PANEL UGR
97



ELIOS
98

LED PANELS

PANEL

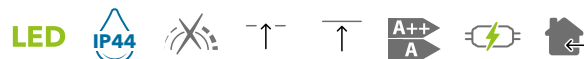

- Corps en aluminium
- Diffuseur en PMMA opalin
- Alimentation dimmable sur demande

RÉF. ID	PUISSANCE	FLUX	T°	IRC	DIMENSIONS MM	PRIX HTVA
ID/02444092	40W	3290 LM	3000°K	>85	595 X 595	€ 60,00
ID/02444093	40W	3350 LM	4000°K	>85	595 X 595	€ 60,00
ID/02792010	40W	3290 LM	3000°K	>80	1195 X 295	€ 100,00
ID/02785633	40W	3290 LM	4000°K	>80	1195 X 295	€ 100,00
ID/03130735	72W	7100 LM	3000°K	>80	1195 X 595	€ 200,00
ID/02785634	72W	7000 LM	4000°K	>80	1195 X 595	€ 200,00

ACCESSOIRES

RÉF. ID	ACCESSOIRES EN OPTION	PRIX HTVA
ID/03546857	DRIVER UNIVERSEL DIMMABLE 45W PUSH/0-10V/PWM/DALI	€ 48,00
ID/03483056	KIT DE SUSPENSION POUR PANEL 600 X 600 - 4 CÂBLES	€ 13,70
ID/03483057	KIT DE SUSPENSION POUR PANEL 1200 X 300 - 1200 X 600 - 6 CÂBLES	€ 22,00
ID/02741659	CADRE, MONTAGE PLAFONNIER 60X60	€ 30,00
ID/02792009	CADRE, MONTAGE PLAFONNIER 30X120	€ 36,00
ID/03232780	UNITÉ DE SECOURS 1H (INCOMPATIBLE AVEC LES 60 X 120)	€ 75,00
ID/03232781	UNITÉ DE SECOURS 3H (INCOMPATIBLE AVEC LES 60 X 120)	€ 84,00

PANEL UGR

5
ANS

LED

IP44

IRC
80



A++
A



UGR
<19

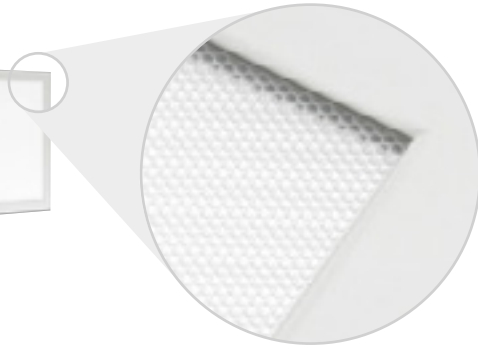

- Corps en aluminium
- Diffuseur micro prismatique
- Dimmable sur demande

En option :
- Contrôle via Casambi voir page 452

LED PANELS

RÉF. ID	PUISSANCE	FLUX	T°	DIMENSIONS MM	PRIX HTVA
ID/03233450	36W	3300 LM	3000°K	595 X 595	€ 74,00
ID/03233448	36W	3500 LM	4000°K	595 X 595	€ 74,00
ID/03233426	36W	3300 LM	3000°K	295 X 1195	€ 110,00
ID/03233424	36W	3500 LM	4000°K	295 X 1195	€ 110,00

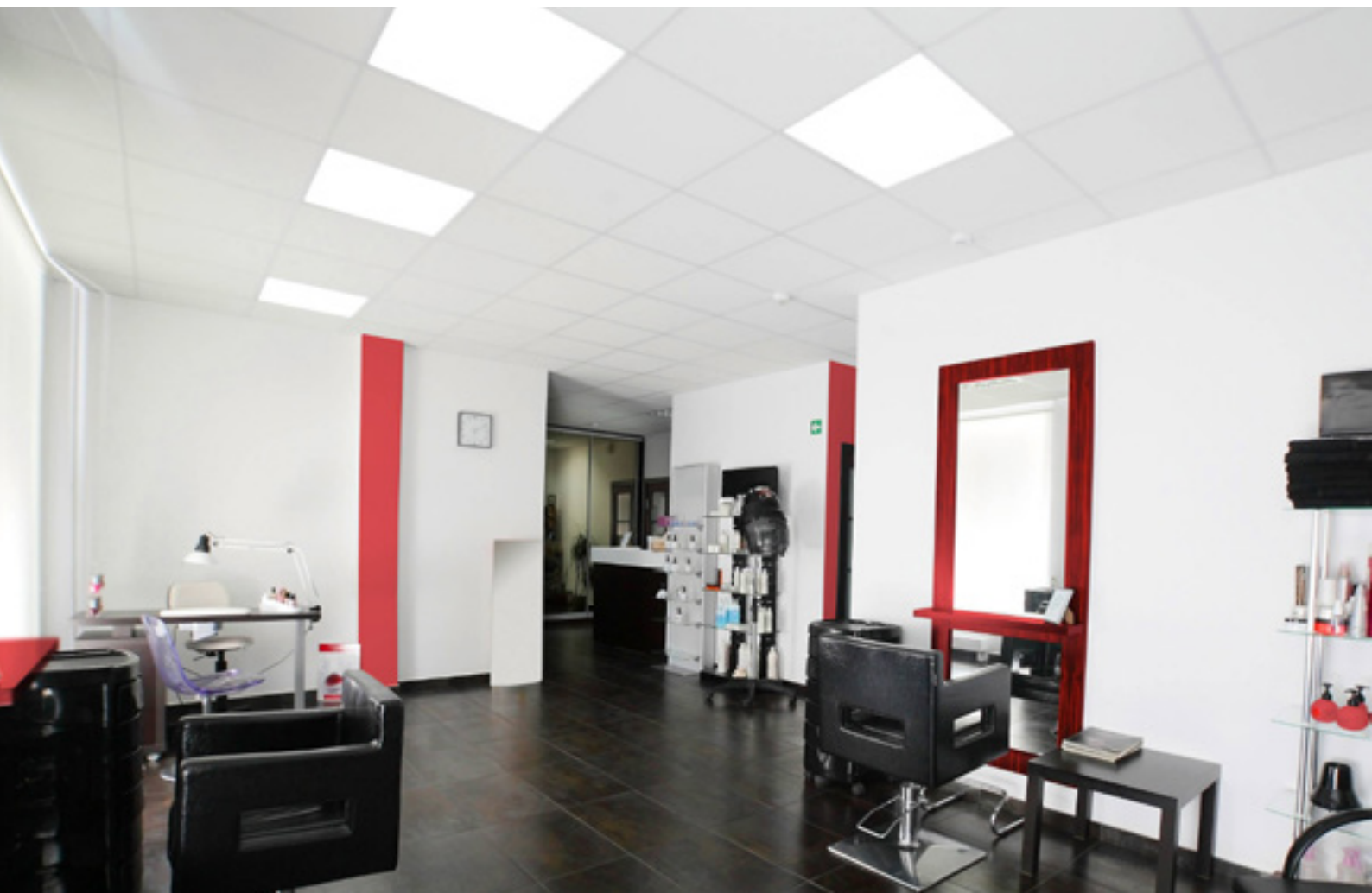

LED PANELS

ELIOS



LED PANELS



Elios donne un rendu naturel et invisible. La lumière est moins agressive et fatigante. Les conditions de travail sont plus agréables.

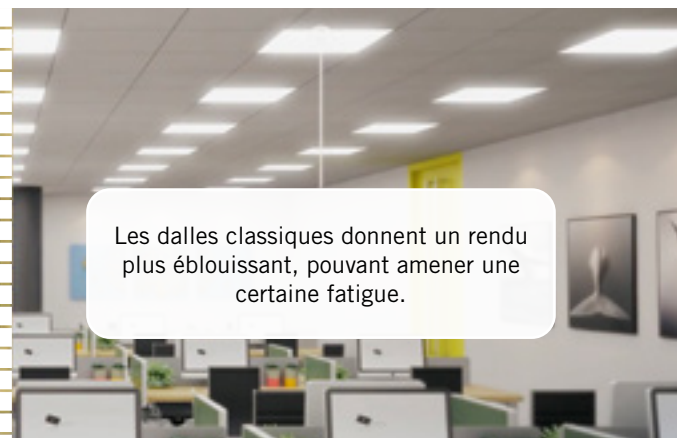

Les dalles classiques donnent un rendu plus éblouissant, pouvant amener une certaine fatigue.



UGR <16



- Convertisseur non dimmable inclus
- 2 modules LED fixés dans une plaque 595 X 595
- Haut rendement supérieur à 126 Lm / W
- Variation DALI ou 1-10 V à commander séparément
- Pas de scintillement
- Fixation encastré ou suspension
- Remplacement de T8 - 3 X 18W / 4 X 18W
- Remplacement de T5 - 3 X 14W / 4 X 14W
- Économie d'énergie de 65 %
- Durée de vie 3X plus longue que pour les tubes fluorescents

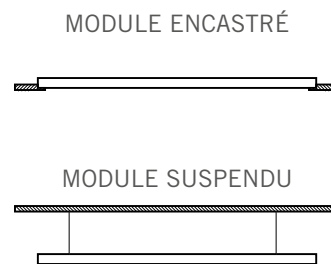
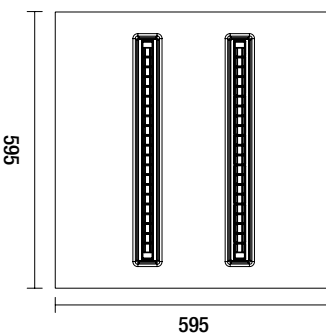

Le conseil de l'éclairagiste:

La valeur UGR (Unified Glare Rating en anglais) est une mesure définie par la Commission internationale de l'éclairage (CIE) pour mesurer le taux d'éblouissement produit par la luminosité dans un environnement précis. Aussi, avec une valeur UGR adaptée au type de travail à exécuter, vous faciliterez la bonne exécution des tâches avec un meilleur confort visuel limitant aussi les effets de fatigue.

RÉF. ID	PUISSANCE	FLUX	T°	DIMENSIONS MM	PRIX HTVA
ID/02602372	28W	3400 LM	3000°K	595 X 595	€ 80,00
ID/02554260	28W	3600 LM	4000°K	595 X 595	€ 80,00
ID/03546858	DRIVER UNIVERSEL DIMMABLE 28W PUSH/0-10V/PWM/DALI				€ 37,00
ID/03546968	DRIVER 50W ZIGBEE				€ 105,00
ID/02554266	KIT SUSPENSION POUR ELIOS- 4 CÂBLES				€ 7,40

QU'EST-CE QUE L'UGR ?

Le facteur UGR donne une idée du taux d'éblouissement ressenti par un observateur dans un espace. Il tient compte de tous les luminaires présents et pouvant participer à cet éblouissement. Ce facteur UGR varie de 6 à 30. Plus la valeur du facteur est élevée, plus la probabilité d'éblouissement est importante.

Des valeurs de référence définissent des classes de qualité :

UGR	Activité
28	Zone de circulation, quais...
25	Salle d'archives, escaliers, ascenseur...
22	Espace d'accueil, industrie, artisanat...
19	Activités de bureau, écoles...
16	Dessins techniques, postes de travail CAO...

Certains facteurs ont un impact sur la valeur UGR :

- la forme et les dimensions du local
- la couleur et la finition des surfaces (plafond, sol, surfaces de travail)
- le type de luminaire
- la luminance de la source
- la disposition des luminaires
- la disposition des postes de travail
- ...



PLAFONNIERS

PAGES 100 À 121

De tous styles, formes, finitions et puissances, les plafonniers procurent une lumière diffuse. Un excellent choix lorsqu'un éclairage avec une répartition de la lumière la plus uniforme possible est demandé.



PLAFONNIERS



SF CIRCULAR
102



NEW
BAMBURGH
102



ALIEN MINI
103



CLX+
103



ANDRIA
104



FOGGIA
105



KORBA
106



DUBLIN
107



NEW
STOCKHOLM
107



NEW
QIJO
108



CERES ROND
108



NEW
GOA
109



CERES CARRÉ
109



MOON 500
110



OSLO
110



NEW
ORKI
110



LA PAZ 20
111



LA PAZ 40
111



NEW
CHIBA
112



TALOWE
113



AURA 3
114



AURA 4
114



ENIMA
115



TRIMLESS
116



RODA C
118



SULLY C
118



LEDLINER 35
119



MANUELA
120



ARTHUR
120



THOR
121

PLAFONNIERS

SF CIRCULAR

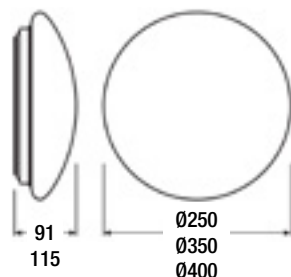

RÉF. ID	PUISSANCE	FLUX	T°	COULEUR	DIMENSIONS MM	MATÉRIAU	PRIX HTVA
ID/02866310	13W	920 LM	3000°K	○ BLANC	Ø 250 X 91	ACIER/PMMA	€ 35,00
ID/02866311	13W	920 LM	4000°K	○ BLANC	Ø 250 X 91	ACIER/PMMA	€ 35,00
ID/02866306	18W	1440 LM	3000°K	○ BLANC	Ø 350 X 115	ACIER/PMMA	€ 42,00
ID/02866307	18W	1440 LM	4000°K	○ BLANC	Ø 350 X 115	ACIER/PMMA	€ 42,00
ID/02866308	24W	1920 LM	3000°K	○ BLANC	Ø 400 X 120	ACIER/PMMA	€ 49,00
ID/02866309	24W	1920 LM	4000°K	○ BLANC	Ø 400 X 120	ACIER/PMMA	€ 49,00

Disponible avec détecteur voir page 292

BAMBURGH

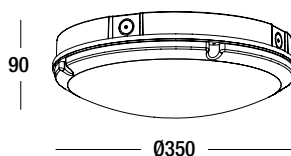
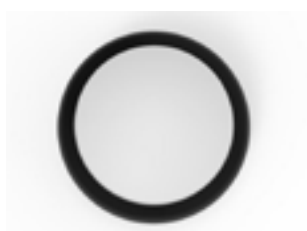





NEW

RÉF. ID	PUISSANCE	FLUX	T°	COULEUR	MATÉRIAU	PRIX HTVA
ID/03473172	12W	1470 LM	4000°K	○ BLANC	ABS	€ 51,00
ID/03473180	12W	1330 LM	4000°K	● NOIR	ABS	€ 51,00
ID/03473176	18W	2100 LM	4000°K	○ BLANC	ABS	€ 63,00
ID/03473184	18W	1900 LM	4000°K	● NOIR	ABS	€ 63,00

Disponible avec détecteur page 292
Disponible avec détecteur et secours page 424

ALIEN MINI

LED IP54    A+ 230V  

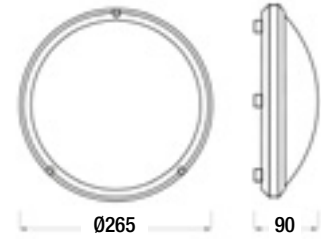

Le conseil de l'éclairagiste:

IK est l'indice de résistance à des chocs mécaniques. Par exemple, un luminaire IK10 résiste à des chocs de 20 joules soit une masse de 5kg tombant sur le luminaire à une hauteur de 400mm. Idéal pour une buanderie, un atelier, un garage et les lieux collectifs.

RÉF. ID	PUISSANCE	FLUX	T°	COULEUR	MATÉRIAU	PRIX HTVA
ID/03136831	13W	1500 LM	3000°K	○ BLANC	POLYCARBONATE	€ 78,00
ID/03136833	13W	1500 LM	3000°K	● NOIR	POLYCARBONATE	€ 78,00
ID/03136827	13W	1500 LM	4000°K	○ BLANC	POLYCARBONATE	€ 78,00
ID/03136829	13W	1500 LM	4000°K	● NOIR	POLYCARBONATE	€ 78,00

Disponible avec détecteur voir page 293

CLX+

LED 5 ANS IP65  IRC 80   A++/A 230V  



- Optique symétrique extra diffusante
- Réglage de la température par Dip-switch

RÉF. ID	PUISSANCE	FLUX	T°	COULEUR	MATÉRIAU	PRIX HTVA
ID/02731368	14,5W	1610 LM	3000 - 4000°K	○ BLANC	TECHNOPOLYMÈRE	€ 65,00

Disponible avec détecteur page 294
Disponible avec détecteur et secours page 425

PLAFONNIERS

ANDRIA

LED

3
ANS

IP40

120°

IRC
80



230V



- Plafonnier rond ultra plat
- Aucune vis apparente
- Diffuseur polycarbonate opalin.



Ø140 - Ø190 - Ø240

RÉF. ID	PUISSANCE	FLUX	T°	COULEUR	DIMENSIONS MM	MATÉRIAU	PRIX HTVA
ID/03383250	12W	960 LM	2700°K	● NOIR	Ø 140 X 24	ALUMINIUM	€ 34,00
ID/02517972	12W	960 LM	3000°K	○ BLANC	Ø 140 X 24	ALUMINIUM	€ 34,00
ID/03383251	12W	960 LM	3000°K	● NOIR	Ø 140 X 24	ALUMINIUM	€ 34,00
ID/02517973	12W	960 LM	4000°K	○ BLANC	Ø 140 X 24	ALUMINIUM	€ 34,00
ID/03383252	18W	1450 LM	2700°K	● NOIR	Ø 190 X 24	ALUMINIUM	€ 44,00
ID/02517974	18W	1450 LM	3000°K	○ BLANC	Ø 190 X 24	ALUMINIUM	€ 44,00
ID/03383253	18W	1450 LM	3000°K	● NOIR	Ø 190 X 24	ALUMINIUM	€ 44,00
ID/02517975	18W	1450 LM	4000°K	○ BLANC	Ø 190 X 24	ALUMINIUM	€ 44,00
ID/03383254	24W	1920 LM	2700°K	● NOIR	Ø 240 X 24	ALUMINIUM	€ 56,00
ID/02517976	24W	2000 LM	3000°K	○ BLANC	Ø 240 X 24	ALUMINIUM	€ 56,00
ID/03383255	24W	1920 LM	3000°K	● NOIR	Ø 240 X 24	ALUMINIUM	€ 56,00
ID/02517977	24W	1920 LM	4000°K	○ BLANC	Ø 240 X 24	ALUMINIUM	€ 56,00

FOGGIA

LED IP40 120° IRC 80    230V 



- Plafonnier carré ultra plat
- Aucune vis apparente
- Diffuseur polycarbonate opalin.

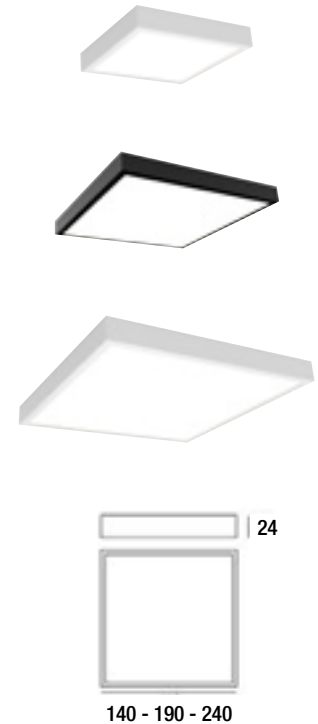

RÉF. ID	PUISSANCE	FLUX	T°	COULEUR	DIMENSIONS MM	MATÉRIAU	PRIX HTVA
ID/03383242	12W	960 LM	2700°K	● NOIR	24 X 140 X 140	ALUMINIUM	€ 34,00
ID/02517964	12W	960 LM	3000°K	○ BLANC	24 X 140 X 140	ALUMINIUM	€ 34,00
ID/03383243	12W	960 LM	3000°K	● NOIR	24 X 140 X 140	ALUMINIUM	€ 34,00
ID/02517965	12W	960 LM	4000°K	○ BLANC	24 X 140 X 140	ALUMINIUM	€ 34,00
ID/03383244	18W	1450 LM	2700°K	● NOIR	24 X 190 X 190	ALUMINIUM	€ 44,00
ID/02517966	18W	1450 LM	3000°K	○ BLANC	24 X 190 X 190	ALUMINIUM	€ 44,00
ID/03383245	18W	1450 LM	3000°K	● NOIR	24 X 190 X 190	ALUMINIUM	€ 44,00
ID/02517967	18W	1450 LM	4000°K	○ BLANC	24 X 190 X 190	ALUMINIUM	€ 44,00
ID/03383246	24W	1920 LM	2700°K	● NOIR	24 X 240 X 240	ALUMINIUM	€ 56,00
ID/02517968	24W	1920 LM	3000°K	○ BLANC	24 X 240 X 240	ALUMINIUM	€ 56,00
ID/03383247	24W	1920 LM	3000°K	● NOIR	24 X 240 X 240	ALUMINIUM	€ 56,00
ID/02517969	24W	1920 LM	4000°K	○ BLANC	24 X 240 X 240	ALUMINIUM	€ 56,00

PLAFONNIERS

KORBA



- Diffuseur opalin
- Maintien du corps du luminaire sur la base par 1/4 de tour (pas de vis apparentes)

RÉF. ID	PUISSANCE	FLUX	T°	COULEUR	DIMENSIONS MM	MATÉRIAU	PRIX HTVA
ID/02484239	13W	950 LM	3000°K	○ BLANC	Ø 147 X 42	ALUMINIUM	€ 53,00
ID/02610030	13W	950 LM	3000°K	● NOIR	Ø 147 X 42	ALUMINIUM	€ 53,00
ID/02484238	13W	1000 LM	4000°K	○ BLANC	Ø 147 X 42	ALUMINIUM	€ 53,00
ID/02610031	13W	1000 LM	4000°K	● NOIR	Ø 147 X 42	ALUMINIUM	€ 53,00
ID/02484243	17W	1350 LM	3000°K	○ BLANC	Ø 182 X 42	ALUMINIUM	€ 63,00
ID/02610036	17W	1350 LM	3000°K	● NOIR	Ø 182 X 42	ALUMINIUM	€ 63,00
ID/02484242	17W	1500 LM	4000°K	○ BLANC	Ø 182 X 42	ALUMINIUM	€ 63,00
ID/02610037	17W	1500 LM	4000°K	● NOIR	Ø 182 X 42	ALUMINIUM	€ 63,00
ID/02484248	24W	1800 LM	3000°K	○ BLANC	Ø 242 X 42	ALUMINIUM	€ 74,00
ID/02610042	24W	1800 LM	3000°K	● NOIR	Ø 242 X 42	ALUMINIUM	€ 74,00
ID/02484247	24W	2000 LM	4000°K	○ BLANC	Ø 242 X 42	ALUMINIUM	€ 74,00
ID/02610043	24W	2000 LM	4000°K	● NOIR	Ø 242 X 42	ALUMINIUM	€ 74,00



DUBLIN

LED 3 ANS IP20 150° IRC 80 230V



- Diffuseur opalin
- Aucune fixation visible pour le 7 et 15W
- Angle de diffusion très large de 150°
- Alimentation dimmable en option

RÉF. ID	PUISSANCE	FLUX	T°	COULEUR	DIMENSIONS MM	MATÉRIAU	PRIX HTVA
ID/01736089	7W	560 LM	3000°K	○ BLANC	Ø 75 X 65	ALUMINIUM	€ 35,00
ID/03174673	7W	560 LM	3000°K	● NOIR	Ø 75 X 65	ALUMINIUM	€ 35,00
ID/01736090	15W	1200 LM	3000°K	○ BLANC	Ø 135 X 75	ALUMINIUM	€ 62,00
ID/03174674	15W	1200 LM	3000°K	● NOIR	Ø 135 X 75	ALUMINIUM	€ 62,00
ID/01736091	25W	2000 LM	3000°K	○ BLANC	Ø 190 X 90	ALUMINIUM	€ 98,00
ID/03174675	25W	2000 LM	3000°K	● NOIR	Ø 190 X 90	ALUMINIUM	€ 98,00
ID/03383220	ALIMENTATION LED POUR DUBLIN 7W DIMMABLE TRIAC						€ 22,00
ID/03383221	ALIMENTATION LED POUR DUBLIN 15W DIMMABLE TRIAC						€ 31,00
ID/03383222	ALIMENTATION LED POUR DUBLIN 25W DIMMABLE TRIAC						€ 37,00

STOCKHOLM

LED 3 ANS IP65 110° IRC 80 230V

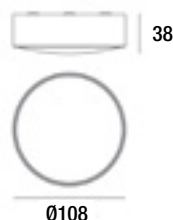

- Diffuseur : lentille en verre

NEW

RÉF. ID	PUISSANCE	FLUX	T°	COULEUR	MATÉRIAU	PRIX HTVA
ID/03383168	6W	420 LM	3000°K	● GRIS ANTHRACITE	ALUMINIUM	€ 81,00
ID/03383169	6W	420 LM	3000°K	● NOIR	ALUMINIUM	€ 81,00

PLAFONNIERS

QIJO

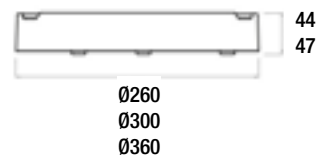

PLAFONNIERS

NEW

RÉF. ID	PUISSANCE	FLUX	T°	COULEUR	DIMENSIONS MM	MATÉRIAU	PRIX HTVA
ID/02877894	15W	1200 LM	3000°K	○ BLANC	Ø 260 X 44	SYNTHÉTIQUE	€ 57,00
ID/02877893	15W	1200 LM	3000°K	● GRIS	Ø 260 X 44	SYNTHÉTIQUE	€ 57,00
ID/03468787	15W	1200 LM	3000°K	● NOIR	Ø 260 X 44	SYNTHÉTIQUE	€ 57,00
ID/02877896	18W	1450 LM	3000°K	○ BLANC	Ø 300 X 44	SYNTHÉTIQUE	€ 67,00
ID/02877895	18W	1450 LM	3000°K	● GRIS	Ø 300 X 44	SYNTHÉTIQUE	€ 67,00
ID/03468788	18W	1450 LM	3000°K	● NOIR	Ø 300 X 44	SYNTHÉTIQUE	€ 67,00
ID/02877898	28W	2100 LM	3000°K	○ BLANC	Ø 360 X 47	SYNTHÉTIQUE	€ 80,00
ID/02877897	28W	2100 LM	3000°K	● GRIS	Ø 360 X 47	SYNTHÉTIQUE	€ 80,00
ID/03468789	28W	2100 LM	3000°K	● NOIR	Ø 360 X 47	SYNTHÉTIQUE	€ 80,00

CERES ROND

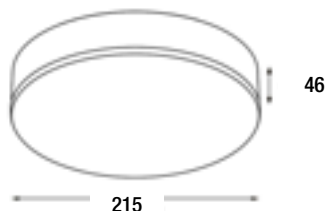

- Diffuseur avec rebord pour une large répartition de la lumière

RÉF. ID	PUISSANCE	FLUX	T°	COULEUR	MATÉRIAU	PRIX HTVA
ID/02695402	30W	2475 LM	3000°K	○ BLANC	ALUMINIUM	€ 91,00
ID/02695401	30W	2475 LM	3000°K	● NOIR	ALUMINIUM	€ 91,00

GOA



- Plafonnier simple, sobre, aux bords arrondis.

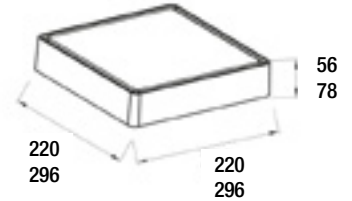

NEW

RÉF. ID	PUISSANCE	FLUX	T°	COULEUR	DIMENSIONS MM	MATÉRIAU	PRIX HTVA
ID/02877890	12W	950 LM	3000°K	○ BLANC	56 X 220 X 220	POLYMÈRE	€ 67,00
ID/02877889	12W	950 LM	3000°K	● GRIS	56 X 220 X 220	POLYMÈRE	€ 67,00
ID/03468785	12W	950 LM	3000°K	● NOIR	56 X 220 X 220	POLYMÈRE	€ 67,00
ID/02877892	16W	1280 LM	3000°K	○ BLANC	78 X 296 X 296	POLYMÈRE	€ 77,00
ID/02877891	16W	1280 LM	3000°K	● GRIS	78 X 296 X 296	POLYMÈRE	€ 77,00
ID/03468786	16W	1280 LM	3000°K	● NOIR	78 X 296 X 296	POLYMÈRE	€ 77,00

CERES CARRÉ



- Diffuseur avec rebord pour une large répartition de la lumière



RÉF. ID	PUISSANCE	FLUX	T°	COULEUR	MATÉRIAU	PRIX HTVA
ID/02695404	30W	2475 LM	3000°K	○ BLANC	ALUMINIUM	€ 91,00
ID/02695403	30W	2475 LM	3000°K	● NOIR	ALUMINIUM	€ 91,00

PLAFONNIERS

MOON 500

LED IP20 IRC 80 230V



HAUT RENDEMENT

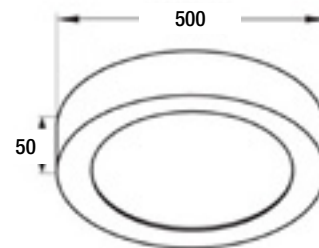

RÉF. ID	PUISSANCE	FLUX	T°	COULEUR	MATÉRIAU	PRIX HTVA
ID/02578889	42W	3100 LM	3000°K	○ BLANC	ALUMINIUM	€ 199,00
ID/03482051	42W	3100 LM	3000°K	● NOIR MAT	ALUMINIUM	€ 199,00

OSLO

LED IP20 230V

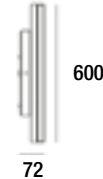

RÉF. ID	PUISSANCE	FLUX	T°	COULEUR	DIMENSIONS MM	MATÉRIAU	PRIX HTVA
ID/01449019	40W	2500 LM	3000°K	○ BLANC BRILLANT	Ø 400 X 72	ALUMINIUM	€ 142,00
ID/02108668	70W	4000LM	3000°K	○ BLANC BRILLANT	Ø 600 X 72	ALUMINIUM	€ 314,00

ORKI

LED 3 ANS IP54 360° IRC 85 IK10 230V



- Plafonnier ou applique murale
- 3000K ou 4000K au choix via un interrupteur à l'arrière du luminaire.
- Convertisseur non dimmable intégré dans l'appareil.

NEW

RÉF. ID	PUISSANCE	FLUX	T°	COULEUR	MATÉRIAU	PRIX HTVA
ID/03286991	18W	2730 LM	3000 - 4000°K	○ BLANC	POLYCARBONATE	€ 75,00

Disponible avec détecteur page 110

LA PAZ 20

LED 3 ANS IP40 140° IRC 75 IK08 ↑ A 230V

- Diffuseur polycarbonate opalin
- Alimentation dimmable Triac sur demande

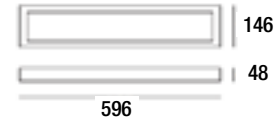

RÉF. ID	PUISSANCE	FLUX	T°	COULEUR	MATÉRIAU	PRIX HTVA
ID/03383195	22W	1300 LM	2700°K	● NOIR	ALUMINIUM	€ 136,00
ID/02122136	22W	1372 LM	3000°K	○ BLANC	ALUMINIUM	€ 136,00
ID/03383194	22W	1372 LM	3000°K	● NOIR	ALUMINIUM	€ 136,00
ID/02122137	22W	1450 LM	4000°K	○ BLANC	ALUMINIUM	€ 136,00

LA PAZ 40

LED 3 ANS IP20 140° IRC 75 IK08 ↑ A 230V

- Diffuseur polycarbonate opalin
- Alimentation dimmable Triac sur demande



RÉF. ID	PUISSANCE	FLUX	T°	COULEUR	MATÉRIAU	PRIX HTVA
ID/03383197	40W	2300 LM	2700°K	● NOIR	ALUMINIUM	€ 209,00
ID/02122138	40W	2428 LM	3000°K	○ BLANC	ALUMINIUM	€ 209,00
ID/03383196	40W	2428 LM	3000°K	● NOIR	ALUMINIUM	€ 209,00
ID/02122139	40W	2698 LM	4000°K	○ BLANC	ALUMINIUM	€ 209,00

PLAFONNIERS

CHIBA

LED 3 ANS IP20 120° IRC 80 TRIAC ↑ A++ A 230V

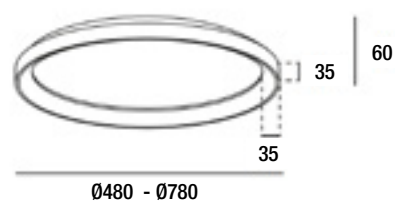

PLAFONNIERS

NEW

RÉF. ID	PUISSANCE	FLUX	T°	COULEUR	DIMENSIONS MM	MATÉRIAU	PRIX HTVA
ID/03383232	38W	2470 LM	3000°K	○ BLANC	Ø 480 X 60	ALUMINIUM / ACRYLIQUE	€ 259,00
ID/03383233	38W	2470 LM	3000°K	● NOIR	Ø 480 X 60	ALUMINIUM / ACRYLIQUE	€ 259,00
ID/03383234	60W	3900 LM	3000°K	○ BLANC	Ø 780 X 60	ALUMINIUM / ACRYLIQUE	€ 495,00
ID/03383235	60W	3900 LM	3000°K	● NOIR	Ø 780 X 60	ALUMINIUM / ACRYLIQUE	€ 495,00



TALOWE

LED 3 ANS IP20 IRC 80 TRIAC ↑ A++ A 230V

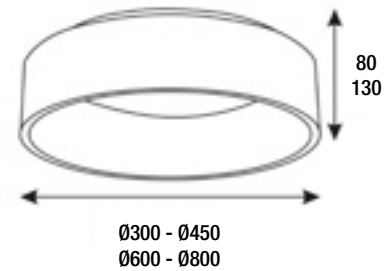

RÉF. ID	PUISSANCE	FLUX	T°	COULEUR	DIMENSIONS MM	MATÉRIAU	PRIX HTVA
ID/02773230	20W	1200 LM	3000°K	○ BLANC	Ø 300 X 80	ALUMINIUM / ACRYLIQUE	€ 94,00
ID/02773229	20W	1200 LM	3000°K	● NOIR	Ø 300 X 80	ALUMINIUM / ACRYLIQUE	€ 107,00
ID/02325580	30W	1800 LM	3000°K	○ BLANC	Ø 450 X 130	ALUMINIUM / ACRYLIQUE	€ 207,00
ID/02773231	30W	1800 LM	3000°K	● NOIR	Ø 450 X 130	ALUMINIUM / ACRYLIQUE	€ 215,00
ID/02773233	42W	2520 LM	3000°K	○ BLANC	Ø 600 X 130	ALUMINIUM / ACRYLIQUE	€ 274,00
ID/02773232	42W	2520 LM	3000°K	● NOIR	Ø 600 X 130	ALUMINIUM / ACRYLIQUE	€ 283,00
ID/02773235	80W	4800 LM	3000°K	○ BLANC	Ø 800 X 130	ALUMINIUM / ACRYLIQUE	€ 479,00
ID/02773234	80W	4800 LM	3000°K	● NOIR	Ø 800 X 130	ALUMINIUM / ACRYLIQUE	€ 496,00

Disponible en suspension page 179

PLAFONNIERS

AURA 3

LED 3 ANS IP20 IRC 80 230V

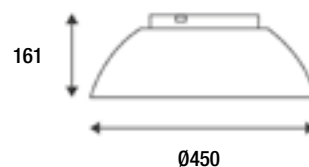
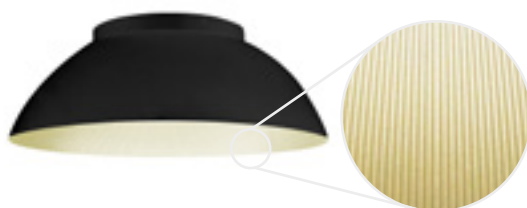

RÉF. ID	PUISSANCE	FLUX	T°	COULEUR	MATÉRIAU	PRIX HTVA
ID/02510162	24W	1680 LM	3000°K	○ BLANC	ALUMINIUM / PMMA	€ 209,00
ID/02510161	24W	1680 LM	3000°K	● NOIR / ● OR	ALUMINIUM / PMMA	€ 209,00

AURA 4

LED 3 ANS IP20 IRC 80 230V

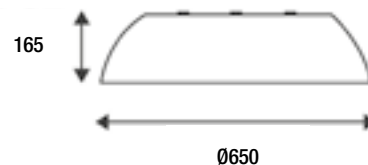

RÉF. ID	PUISSANCE	FLUX	T°	COULEUR	MATÉRIAU	PRIX HTVA
ID/02510164	40W	3000 LM	3000°K	○ BLANC	ALUMINIUM / PMMA	€ 390,00
ID/02510163	40W	3000 LM	3000°K	● NOIR / ● OR	ALUMINIUM / PMMA	€ 390,00



ENIMA

LED
5 ANS
IP40
120°
IRC ≥90
TRIAC
↑
←
A+
230V

- Peinture epoxy blanc structuré
- Cordon de sécurité évitant toute chute
- Système de push, turn and lock.

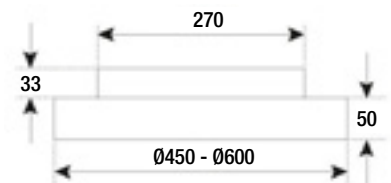

**+ LUMIÈRE
INDIRECTE**

PLAFONNIERS

RÉF. ID	PUISSANCE	FLUX	T°	COULEUR	DIMENSIONS MM	MATÉRIAU	PRIX HTVA
ID/02558616	24W + 7W	2400 LM	3000°K	○ BLANC	Ø 450 X 83	ALUMINIUM	€ 325,00
ID/02558617	31W + 7W	3200 LM	3000°K	○ BLANC	Ø 600 X 83	ALUMINIUM	€ 445,00

Disponible en suspension page 182

TRIMLESS

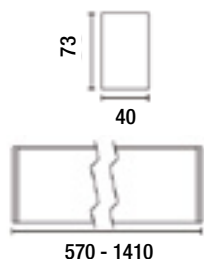

- Corps en aluminium
- Diffuseur en PMMA
- Sur demande : - Alimentation dimmable
- Autres RAL
- Autres dimensions
- 4000°K

Le conseil de l'éclairagiste:

"Certains projets comme des espaces bureaux nécessitent des niveaux d'éclairage variés en fonction de la répartition des espaces. Une collection comme Trimless permet cela tout en garantissant une uniformité de style".

RÉF. ID	PUISSANCE	FLUX	T°	COULEUR	DIMENSIONS MM	PRIX HTVA
ID/02262248	13W	1700 LM	3000°K	○ BLANC	73 X 40 X 570	€ 195,00
ID/02262250	13W	1700 LM	3000°K	● GRIS	73 X 40 X 570	€ 165,00
ID/02262249	13W	1700 LM	3000°K	● NOIR	73 X 40 X 570	€ 195,00
ID/02262242	23W	3250 LM	3000°K	○ BLANC	73 X 40 X 570	€ 165,00
ID/02262244	23W	3250 LM	3000°K	● GRIS	73 X 40 X 570	€ 175,00
ID/02262243	23W	3250 LM	3000°K	● NOIR	73 X 40 X 570	€ 175,00
ID/02262260	19W	2500 LM	3000°K	○ BLANC	73 X 40 X 850	€ 210,00
ID/02262262	19W	2500 LM	3000°K	● GRIS	73 X 40 X 850	€ 210,00
ID/02262261	19W	2500 LM	3000°K	● NOIR	73 X 40 X 850	€ 210,00
ID/02262254	35W	4850 LM	3000°K	○ BLANC	73 X 40 X 850	€ 210,00
ID/02262256	35W	4850 LM	3000°K	● GRIS	73 X 40 X 850	€ 210,00
ID/02262255	35W	4850 LM	3000°K	● NOIR	73 X 40 X 850	€ 210,00
ID/02262272	25W	3400 LM	3000°K	○ BLANC	73 X 40 X 1130	€ 215,00
ID/02262274	25W	3400 LM	3000°K	● GRIS	73 X 40 X 1130	€ 215,00
ID/02262273	25W	3400 LM	3000°K	● NOIR	73 X 40 X 1130	€ 215,00
ID/02262266	46W	6500 LM	3000°K	○ BLANC	73 X 40 X 1130	€ 235,00
ID/02262268	46W	6500 LM	3000°K	● GRIS	73 X 40 X 1130	€ 235,00
ID/02262267	46W	6500 LM	3000°K	● NOIR	73 X 40 X 1130	€ 235,00
ID/02262284	31W	4300 LM	3000°K	○ BLANC	73 X 40 X 1410	€ 225,00
ID/02262286	31W	4300 LM	3000°K	● GRIS	73 X 40 X 1410	€ 245,00
ID/02262285	31W	4300 LM	3000°K	● NOIR	73 X 40 X 1410	€ 245,00
ID/02262278	57W	8100 LM	3000°K	○ BLANC	73 X 40 X 1410	€ 265,00
ID/02262280	57W	8100 LM	3000°K	● GRIS	73 X 40 X 1410	€ 265,00
ID/02262279	57W	8100 LM	3000°K	● NOIR	73 X 40 X 1410	€ 265,00



PLAFONNIERS

RODA C

LED 5 ANS IP20 105° IRC >80 0-10V ↑ A++ 230V



- Diffuseur en polycarbonate
- Convertisseur dimmable 0-10V intégré dans le profil

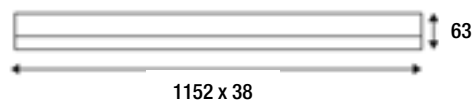

RÉF. ID	PUISSANCE	FLUX	T°	COULEUR	MATÉRIAU	PRIX HTVA
ID/03126151	18W	1900 LM	3000°K	○ BLANC	ALU	€ 175,00
ID/03126150	18W	1900 LM	3000°K	● NOIR	ALU	€ 175,00
ID/03126149	18W	2000 LM	4000°K	○ BLANC	ALU	€ 175,00
ID/03126148	18W	2000 LM	4000°K	● NOIR	ALU	€ 175,00

Disponible en suspension page 188

SULLY C

LED 5 ANS IP20 105° IRC >80 DALI ↑ A++ 230V

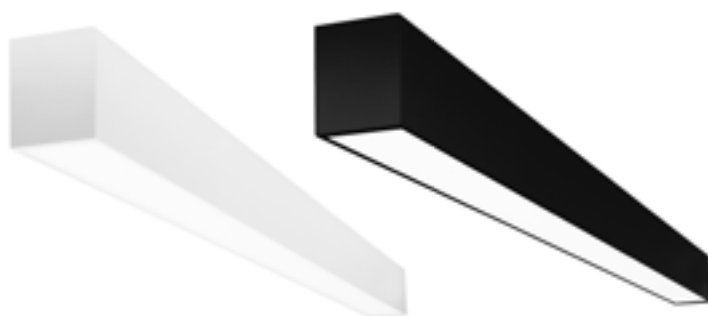

- Diffuseur en polycarbonate
- Convertisseur dimmable DALI intégré dans le profil

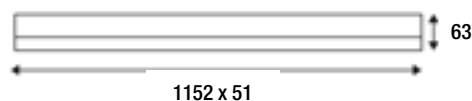

RÉF. ID	PUISSANCE	FLUX	T°	COULEUR	MATÉRIAU	PRIX HTVA
ID/03126155	26W	2850 LM	3000°K	○ BLANC	ALU	€ 320,00
ID/03126154	26W	2850 LM	3000°K	● NOIR	ALU	€ 320,00
ID/03126153	26W	3000 LM	4000°K	○ BLANC	ALU	€ 320,00
ID/03126152	26W	3000 LM	4000°K	● NOIR	ALU	€ 320,00

Disponible en suspension page 188

LEDLINER 35

LED IP20 105° IRC >80 0-10V ↑ A++ A 230V

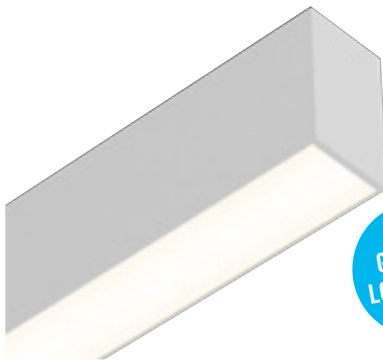

GRANDES LONGUEURS

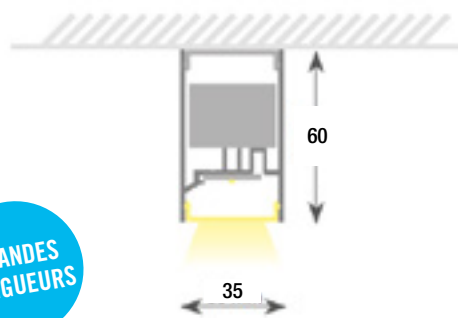

- Diffuseur en polycarbonate
- Convertisseur dimmable 0-10V intégré dans le profil

RÉF. ID	PUISSANCE	FLUX	T°	COULEUR	DIMENSIONS MM	MATÉRIAU	PRIX HTVA
ID/02769195	40.3W	6786 LM	3000°K	○ BLANC	1863 X 60 X 35	ALU	€ 475,00
ID/03000210	40.3W	6786 LM	3000°K	● NOIR	1863 X 60 X 35	ALU	€ 475,00
ID/02769199	52.7W	8874 LM	3000°K	○ BLANC	2424 X 60 X 35	ALU	€ 558,00
ID/03000218	52.7W	8874 LM	3000°K	● NOIR	2424 X 60 X 35	ALU	€ 558,00
ID/02769203	65.1W	10962 LM	3000°K	○ BLANC	2986 X 60 X 35	ALU	€ 756,00
ID/03000226	65.1W	10962 LM	3000°K	● NOIR	2986 X 60 X 35	ALU	€ 756,00
ID/02769210	86.8W	14616 LM	3000°K	○ BLANC	3968 X 60 X 35	ALU	€ 937,00
ID/03000240	86.8W	14616 LM	3000°K	● NOIR	3968 X 60 X 35	ALU	€ 937,00
ID/02769217	108.5W	18270 LM	3000°K	○ BLANC	4952 X 60 X 35	ALU	€ 1088,00
ID/03000254	108.5W	18270 LM	3000°K	● NOIR	4952 X 60 X 35	ALU	€ 1088,00

Disponible en suspension page 191



PLAFONNIERS

MANUELA

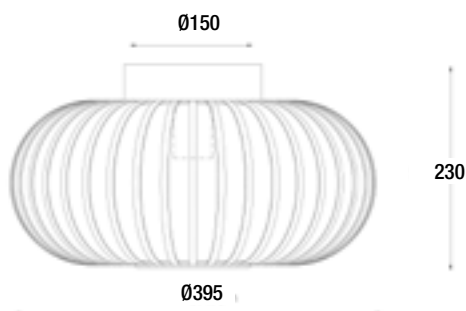
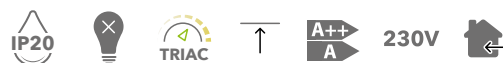

PLAFONNIERS

RÉF. ID	CULOT	PUISSANCE MAX	FLUX MAX	COULEUR	MATÉRIAU	PRIX HTVA
ID/02695451	E27	9W	800 LM	○ BLANC	MÉTAL	€ 66,00
ID/02695450	E27	9W	800 LM	● NOIR	MÉTAL	€ 66,00

Disponible en suspension page 168

ARTHUR

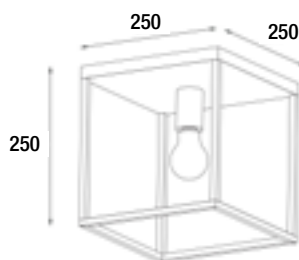
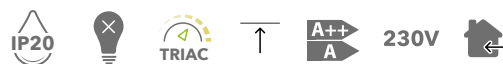

RÉF. ID	CULOT	PUISSANCE MAX	FLUX MAX	COULEUR	MATÉRIAU	PRIX HTVA
ID/02773193	E27	9W	800 LM	● NOIR	MÉTAL	€ 40,00

Disponible en suspension page 165
 Disponible en applique page 206
 Disponible en lampe à poser page 230

THOR



230V

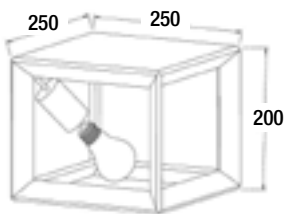

RÉF. ID	CULOT	PUISSANCE MAX	FLUX MAX	COULEUR	MATÉRIAU	PRIX HTVA
ID/02612159	E27	9W	800 LM	● FER GRIS	MÉTAL	€ 97,00

Disponible en suspension page 166
 Disponible en applique page 207
 Disponible en lampe à poser page 231

SPOTS APPARENTS

PAGES 122 À 151

Vous cherchez une solution décorative, pratique pour éclairer des espaces comme un corridor, une cuisine, un salon...? Vous ne pouvez pas ou ne souhaitez pas faire appel aux spots encastrés ? Alors, optez pour des spots apparents fixes ou orientables.



SPOTS APPARENTS

									
BODI ROND 124	BODI 124	BENTOO 125	NEW RIMINI 126	NEW LA ROCHELLE 126	NEW TELA 10/20/30/40 127	RAY 1.0 129	BOX 1.0 130	BOX 2.0 131	
									
NEW KUANA 132	NEW LUPO 1 GU10 133	NEW LUPO 1 133	NEW LUPO 2 133	CUBE LUX 134	CUBE DOUBLE LUX 134	XIRAX 136	ZEFIX 137	NEW TALA 137	
									
NEW MANYL 1 138	NEW MANYL 2 GU10 138	NEW MANYL 2 138	GREG 139	ROTTERDAM 139	CLAC 1 MINI 140	CLAC 2 MINI 140	NEW NIGEL 141	NEW SPLIT 1/2/3 142	
									
XYRUS 143	JASTER LED 144	NEW RILOU 145	NEW TURNON 145	NYSIT 146	LOPAL NEW 147	NAULA SPOT 40 148	NAULA SPOT 60 148	NAULA BASE RONDE 149	
									
NAULA BASE CARRÉE 149	NAULA BASE LINÉAIRE ASYMÉTRIQUE 150	NAULA BASE LINÉAIRE SYMÉTRIQUE 150							

SPOTS APPARENTS

BODI ROND

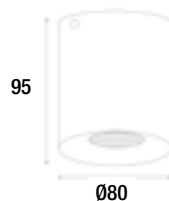

RÉF. ID	CULOT	PUISSANCE MAX	FLUX MAX	COULEUR	PRIX HTVA
ID/01609948	GU10	9W	575LM	○ BLANC	€ 16,50
ID/01609946	GU10	9W	575LM	● ALU	€ 16,50
ID/01609947	GU10	9W	575LM	● NOIR	€ 16,50

BODI

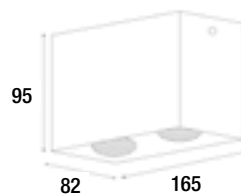
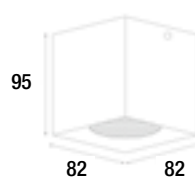
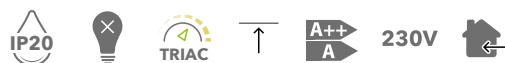

RÉF. ID	CULOT	PUISSANCE MAX	FLUX MAX	COULEUR	PRIX HTVA
ID/01609951	1 X GU10	1 X 9W	1 X 575LM	○ BLANC	€ 16,50
ID/01609950	1 X GU10	1 X 9W	1 X 575LM	● NOIR	€ 16,50
ID/01609954	2 X GU10	2 X 9W	2 X 575LM	○ BLANC	€ 31,00
ID/01609953	2 X GU10	2 X 9W	2 X 575LM	● NOIR	€ 31,00

SPOTS APPARENTS

BENTOO

LED IP20 40° IRC 80 TRIAC   A+ 230V 

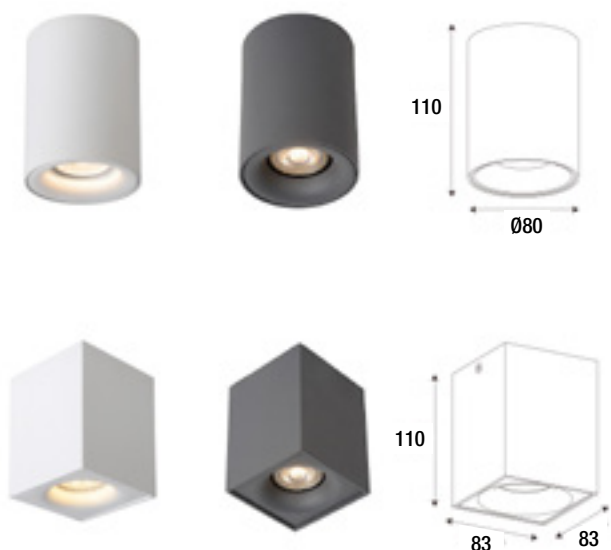

SPOTS APPARENTS

RÉF. ID	CULOT	PUISSANCE	T°	FLUX	COULEUR	FORME	PRIX HTVA
ID/02085345	GU10	4,5W	3000°K	320LM	○ BLANC	ROND	€ 41,00
ID/02085346	GU10	4,5W	3000°K	320LM	● ANTHRACITE	ROND	€ 41,00
ID/02085347	GU10	4,5W	3000°K	320LM	○ BLANC	CARRÉ	€ 41,00
ID/02085348	GU10	4,5W	3000°K	320LM	● ANTHRACITE	CARRÉ	€ 41,00



SPOTS APPARENTS

RIMINI

3 ANS



230V



SPOTS APPARENTS

NEW

RÉF. ID	CULOT	PUISSANCE MAX	FLUX MAX	COULEUR	MATÉRIAU	PRIX HTVA
ID/03383282	GU10	MAX 9W	575 LM	○ BLANC	ALUMINIUM	€ 38,00
ID/03383283	GU10	MAX 9W	575 LM	● NOIR	ALUMINIUM	€ 38,00

LA ROCHELLE

3 ANS



230V

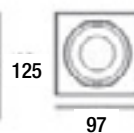
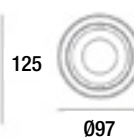

NEW

RÉF. ID	CULOT	PUISSANCE MAX	FLUX MAX	COULEUR	FORME	MATÉRIAU	PRIX HTVA
ID/03174692	GU10	MAX 9W	575 LM	○ BLANC	ROND	ALUMINIUM	€ 42,00
ID/03174693	GU10	MAX 9W	575 LM	● NOIR	ROND	ALUMINIUM	€ 42,00
ID/03174694	GU10	MAX 9W	575 LM	○ BLANC	CARRÉ	ALUMINIUM	€ 42,00
ID/03174695	GU10	MAX 9W	575 LM	● NOIR	CARRÉ	ALUMINIUM	€ 42,00

SPOTS APPARENTS

TELA 10/20/30/40

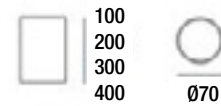

SPOTS APPARENTS

NEW

RÉF. ID	CULOT	PUISSANCE MAX	FLUX MAX	COULEUR	DIMENSIONS MM	MATÉRIAU	PRIX HTVA
ID/03383262	GU10	MAX 9W	575 LM	○ BLANC	Ø 70 X 100	ALUMINIUM	€ 27,00
ID/03383263	GU10	MAX 9W	575 LM	● NOIR	Ø 70 X 100	ALUMINIUM	€ 27,00
ID/03383264	GU10	MAX 9W	575 LM	○ BLANC	Ø 70 X 200	ALUMINIUM	€ 36,00
ID/03383265	GU10	MAX 9W	575 LM	● NOIR	Ø 70 X 200	ALUMINIUM	€ 36,00
ID/03383266	GU10	MAX 9W	575 LM	○ BLANC	Ø 70 X 300	ALUMINIUM	€ 44,00
ID/03383267	GU10	MAX 9W	575 LM	● NOIR	Ø 70 X 300	ALUMINIUM	€ 44,00
ID/03383268	GU10	MAX 9W	575 LM	○ BLANC	Ø 70 X 400	ALUMINIUM	€ 53,00
ID/03383269	GU10	MAX 9W	575 LM	● NOIR	Ø 70 X 400	ALUMINIUM	€ 53,00

RÉF. ID	ACCESSOIRES EN OPTION	PRIX HTVA
ID/03383284	BAGUE DE FINITION BLANCHE	€ 5,30
ID/03383286	BAGUE DE FINITION DOREE	€ 5,30
ID/03383285	BAGUE DE FINITION NOIRE	€ 5,30



RAY 1.0



230V

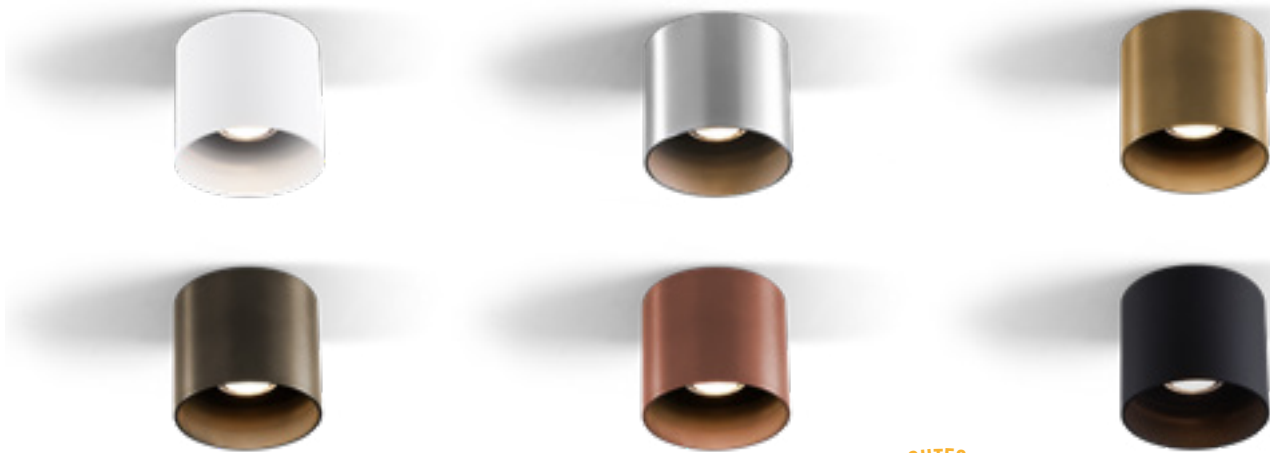

RÉF. ID	CULOT	PUISSANCE MAX	FLUX MAX	COULEUR	PRIX HTVA
ID/01607123	GU10	9W	575 LM	○ BLANC	€ 55,00
ID/01607121	GU10	9W	575 LM	● ALU	€ 57,00
ID/01607120	GU10	9W	575 LM	● DORÉ BROSSÉ	€ 57,00
ID/01607122	GU10	9W	575 LM	● BRONZE BROSSÉ	€ 57,00
ID/01887940	GU10	9W	575 LM	● CUIVRE BROSSÉ	€ 57,00
ID/01607119	GU10	9W	575 LM	● NOIR	€ 55,00

ACCESSOIRES INNER COVER



RÉF. ID	COULEUR	PRIX HTVA
ID/01607127	○ BLANC	€ 19,10
ID/01607126	● OR	€ 19,10
ID/01607124	● NOIR	€ 19,10

SPOTS APPARENTS

BOX 1.0



230V

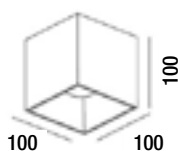
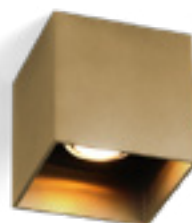

RÉF. ID	CULOT	PUISSANCE MAX	FLUX MAX	COULEUR	PRIX HTVA
ID/01606300	GU10	9W	575 LM	○ BLANC	€ 55,00
ID/01606298	GU10	9W	575 LM	● ALU	€ 57,00
ID/01606297	GU10	9W	575 LM	● DORÉ BROSSÉ	€ 57,00
ID/01606299	GU10	9W	575 LM	● BRONZE BROSSÉ	€ 57,00
ID/01887905	GU10	9W	575 LM	● CUIVRE BROSSÉ	€ 57,00
ID/01606296	GU10	9W	575 LM	● NOIR	€ 55,00

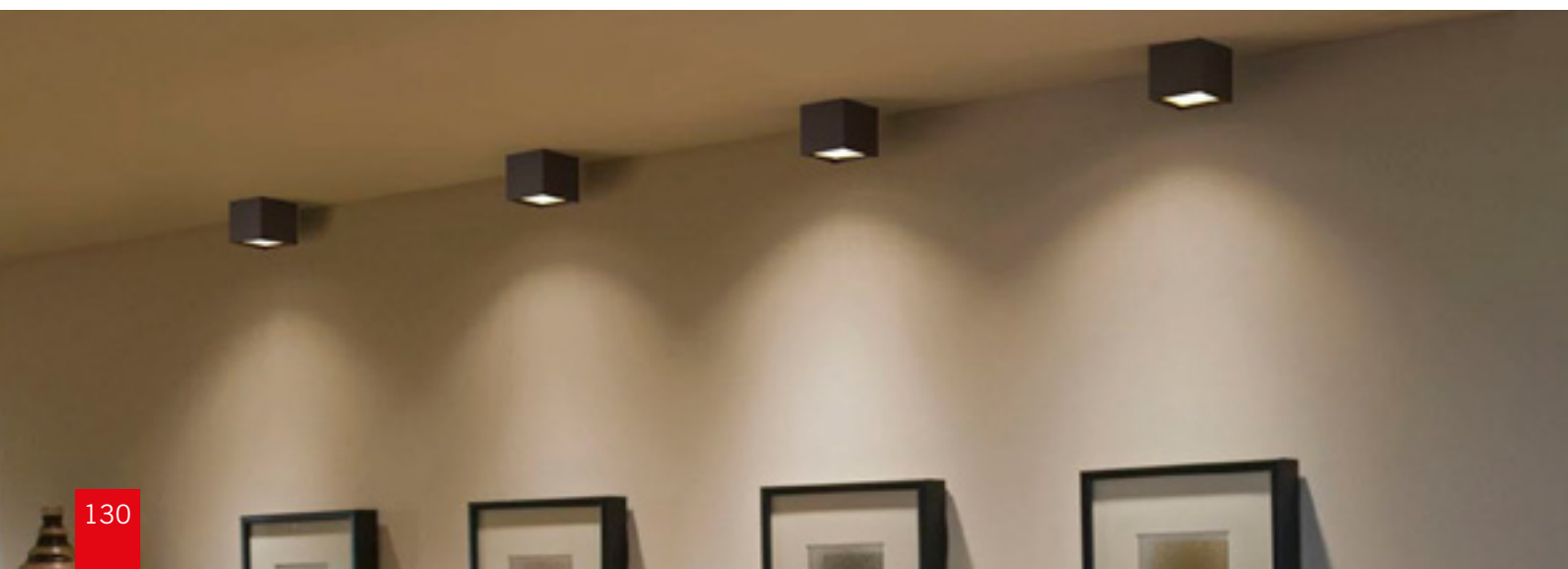

SPOTS APPARENTS

BOX 2.0



230V

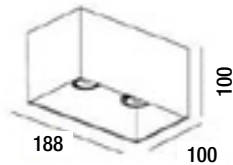

SPOTS APPARENTS

RÉF. ID	CULOT	PUISSANCE MAX	FLUX MAX	COULEUR	PRIX HTVA
ID/01606317	2 X GU10	2 X 9W	2 X 575 LM	○ BLANC	€ 113,00
ID/01606315	2 X GU10	2 X 9W	2 X 575 LM	● ALU	€ 116,00
ID/01606314	2 X GU10	2 X 9W	2 X 575 LM	● DORÉ BROSSÉ	€ 116,00
ID/01606316	2 X GU10	2 X 9W	2 X 575 LM	● BRONZE BROSSÉ	€ 116,00
ID/01887911	2 X GU10	2 X 9W	2 X 575 LM	● CUIVRE BROSSÉ	€ 116,00
ID/01606313	2 X GU10	2 X 9W	2 X 575 LM	● NOIR	€ 113,00

ACCESSOIRES INNER COVER



RÉF. ID	COULEUR	PRIX HTVA
ID/01606322	○ BLANC	€ 19,10
ID/01606321	● OR	€ 19,10
ID/01606319	● NOIR	€ 19,10

SPOTS APPARENTS

KUANA

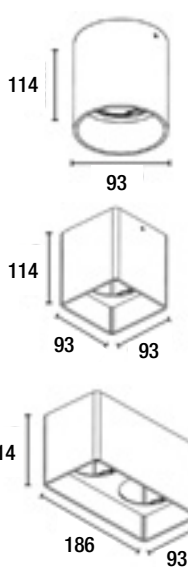

Le luminaire Kuana se compose d'une enveloppe extérieure ronde, carrée simple ou carrée double et d'une ou deux sources lumineuses. A vous de choisir la forme et la finition de la base ainsi que la finition de la source lumineuse.



SPOTS APPARENTS

NEW

RÉF. ID	PUISSANCE	FLUX	T°	COULEUR	MATÉRIAU	PRIX HTVA
ID/03468527	9W	1000 LM	2700°K	○ BLANC	ALUMINIUM	€ 50,00
ID/03468525	9W	1000 LM	2700°K	● CHAMPAGNE	ALUMINIUM	€ 50,00
ID/03468523	9W	1000 LM	2700°K	● NOIR	ALUMINIUM	€ 50,00
ID/03468528	9W	1000 LM	3000°K	○ BLANC	ALUMINIUM	€ 50,00
ID/03468526	9W	1000 LM	3000°K	● CHAMPAGNE	ALUMINIUM	€ 50,00
ID/03468524	9W	1000 LM	3000°K	● NOIR	ALUMINIUM	€ 50,00
RÉF. ID	ACCESSOIRE REQUIS			COULEUR	MATÉRIAU	PRIX HTVA
ID/03582872	BASE APPARENTE RONDE + DRIVER12W			○ BLANC	ALUMINIUM	€ 60,00
ID/03582870	BASE APPARENTE RONDE + DRIVER 12W			● NOIR	ALUMINIUM	€ 60,00
ID/03582871	BASE APPARENTE RONDE + DRIVER 12W			● CHAMPAGNE	ALUMINIUM	€ 60,00
ID/03582877	BASE APPARENTE CARRÉE + DRIVER 12W			○ BLANC	ALUMINIUM	€ 60,00
ID/03582873	BASE APPARENTE CARRÉE + DRIVER 12W			● NOIR	ALUMINIUM	€ 60,00
ID/03582875	BASE APPARENTE CARRÉE + DRIVER 12W			● CHAMPAGNE	ALUMINIUM	€ 60,00
ID/03582878	BASE APPARENTE DOUBLE + DRIVER 20W			○ BLANC	ALUMINIUM	€ 80,00
ID/03582874	BASE APPARENTE DOUBLE + DRIVER 20W			● NOIR	ALUMINIUM	€ 80,00
ID/03582876	BASE APPARENTE DOUBLE + DRIVER 20W			● CHAMPAGNE	ALUMINIUM	€ 80,00

SPOTS APPARENTS

LUPO 1 GU10

3 ANS IP20 20° TRIAC ↑ A++ A 230V

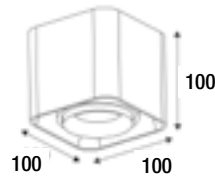

NEW

RÉF. ID	CULOT	PUISSANCE MAX	FLUX MAX	COULEUR	MATÉRIAU	PRIX HTVA
ID/03383032	GU10	MAX 9W	575 LM	○ BLANC MAT	ALUMINIUM	€ 59,00
ID/03383030	GU10	MAX 9W	575 LM	● NOIR MAT	ALUMINIUM	€ 59,00

LUPO 1

LED 3 ANS IP20 15° 38° IRC ≥90 TRIAC ↑ A++ A 230V

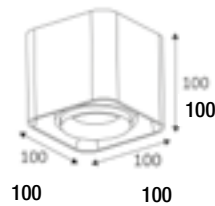

NEW

RÉF. ID	PUISSANCE	FLUX	T°	COULEUR	MATÉRIAU	PRIX HTVA
ID/03383046	10W	435 LM	3000°K	○ BLANC MAT	ALUMINIUM	€ 85,00
ID/03383045	10W	435 LM	3000°K	● NOIR MAT	ALUMINIUM	€ 85,00

LUPO 2

LED 3 ANS IP20 15° 38° IRC ≥90 TRIAC ↑ A++ A 230V

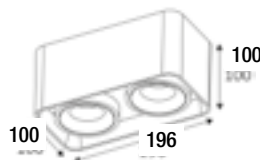

NEW

RÉF. ID	PUISSANCE	FLUX	T°	COULEUR	MATÉRIAU	PRIX HTVA
ID/03383048	2X10W	2 X 435 LM	3000°K	○ BLANC MAT	ALUMINIUM	€ 170,00
ID/03383047	2X10W	2 X 435 LM	3000°K	● NOIR MAT	ALUMINIUM	€ 170,00

SPOTS APPARENTS

CUBE LUX

LED 10 ANS IP21 30° 42° IRC 98 TRIAC ↑ A++ A 230V

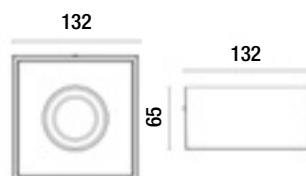

- Convertisseur dimmable par coupure de phase inclus
- Montage sans outils avec connecteur rapide repiquable

RÉF. ID	PUISSANCE	FLUX	T°	COULEUR	MATÉRIAU	PRIX HTVA
ID/02949559	8W	560 LM	3000°K	○ BLANC	ALUMINIUM	€ 85,00
ID/02949565	8W	490 LM	3000°K	● NOIR	ALUMINIUM	€ 85,00

CUBE DOUBLE LUX

LED 10 ANS IP21 30° 42° IRC 98 TRIAC ↑ A++ A 230V

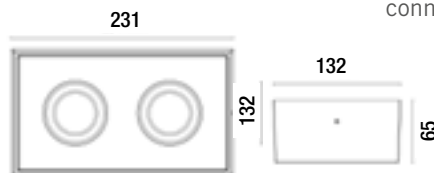

- Convertisseur dimmable par coupure de phase inclus
- Montage sans outils avec connecteur rapide repiquable

RÉF. ID	PUISSANCE	FLUX	T°	COULEUR	MATÉRIAU	PRIX HTVA
ID/02949541	2 X 8W	2X560 LM	3000°K	○ BLANC	ALUMINIUM	€ 130,00
ID/02949547	2 X 8W	2X490 LM	3000°K	● NOIR	ALUMINIUM	€ 130,00



SPOTS APPARENTS

XIRAX

LED



40°

IRC 95



A++
A

230V



DIM-TO-WARM

Le conseil de l'éclairagiste:

Un luminaire équipé de sources Dim-to-Warm, couplé à un variateur, permet de créer des ambiances tamisées avec une couleur de lumière progressivement plus chaude alors que les lampes dimmables traditionnelles permettent d'adapter le flux lumineux mais sans modifier la couleur de lumière.

RÉF. ID	CULOT	PUISSANCE	FLUX	T°	COULEUR	DIMENSIONS MM	PRIX HTVA
ID/03170091	1 X GU10	1 X 5W	1 X 320 LM	2200 - 3000°K	○ BLANC	140 X 140 X 88	€ 50,00
ID/03170090	1 X GU10	1 X 5W	1 X 320 LM	2200 - 3000°K	● NOIR	140 X 140 X 88	€ 50,00
ID/03170093	2 X GU10	2 X 5W	2 X 320 LM	2200 - 3000°K	○ BLANC	250 X 140 X 88	€ 96,00
ID/03170092	2 X GU10	2 X 5W	2 X 320 LM	2200 - 3000°K	● NOIR	250 X 140 X 88	€ 96,00
ID/03170095	3 X GU10	3 X 5W	3 X 320 LM	2200 - 3000°K	○ BLANC	360 X 140 X 88	€ 139,00
ID/03170094	3 X GU10	3 X 5W	3 X 320 LM	2200 - 3000°K	● NOIR	360 X 140 X 88	€ 139,00
ID/03170097	4 X GU10	4 X 5W	4 X 320 LM	2200 - 3000°K	○ BLANC	250 X 250 X 88	€ 190,00
ID/03170096	4 X GU10	4 X 5W	4 X 320 LM	2200 - 3000°K	● NOIR	250 X 250 X 88	€ 190,00



SPOTS APPARENTS

ZEFIX



NEW

RÉF. ID	CULOT	PUISSANCE	FLUX	T°	COULEUR	DIMENSIONS MM	PRIX HTVA
ID/03274700	1 X GU10	1 X 12W	1 X 820 LM	2200 - 3000°K	● NOIR	90 X 185 X 185	€ 81,00
ID/03274701	1 X GU10	1 X 12W	1 X 820 LM	2200 - 3000°K	○ BLANC	90 X 185 X 185	€ 81,00
ID/03274702	2 X GU10	2 X 12W	2 X 820 LM	2200 - 3000°K	● NOIR	90 X 185 X 340	€ 157,00
ID/03274703	2 X GU10	2 X 12W	2 X 820 LM	2200 - 3000°K	○ BLANC	90 X 185 X 340	€ 157,00

TALA



- Source LED au design d'une lampe halogène AR111



NEW

RÉF. ID	CULOT	PUISSANCE	FLUX	T°	COULEUR	DIMENSIONS MM	PRIX HTVA
ID/03382643	1 X GU10	1 X 12W	1 X 820 LM	2200 - 3000°K	● NOIR	200 X 120 X 120	€ 103,00
ID/03382644	1 X GU10	1 X 12W	1 X 820 LM	2200 - 3000°K	○ BLANC	200 X 120 X 120	€ 103,00
ID/03382645	2 X GU10	2 X 12W	2 X 820 LM	2200 - 3000°K	● NOIR	160 X 120 X 280	€ 165,00
ID/03382646	2 X GU10	2 X 12W	2 X 820 LM	2200 - 3000°K	○ BLANC	160 X 120 X 280	€ 165,00
ID/03382647	3 X GU10	3 X 12W	3 X 820 LM	2200 - 3000°K	● NOIR	200 X 120 X 450	€ 223,00
ID/03382648	3 X GU10	3 X 12W	3 X 820 LM	2200 - 3000°K	○ BLANC	200 X 120 X 450	€ 223,00

SPOTS APPARENTS

MANYL 1

LED 3 ANS IP20 355° 36° IRC ≥90 TRIAC ↑ A++ A 230V

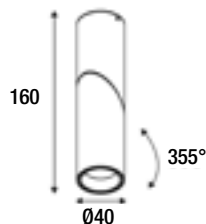

NEW

RÉF. ID	PUISSANCE	FLUX	T°	COULEUR	MATÉRIAU	PRIX HTVA
ID/03383011	5W	449 LM	3000°K	○ BLANC MAT	ALUMINIUM	€ 99,00
ID/03383010	5W	449 LM	3000°K	● NOIR MAT	ALUMINIUM	€ 99,00

MANYL 2 GU10

3 ANS IP20 355° 36° IRC ≥90 TRIAC ↑ A++ A 230V

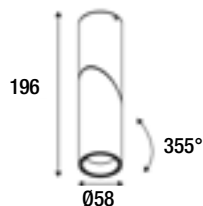

NEW

RÉF. ID	CULOT	PUISSANCE MAX	FLUX MAX	COULEUR	MATÉRIAU	PRIX HTVA
ID/03383029	GU10	MAX 9W	575 LM	○ BLANC MAT	ALUMINIUM	€ 90,00
ID/03383028	GU10	MAX 9W	575 LM	● NOIR MAT	ALUMINIUM	€ 90,00

MANYL 2

LED 3 ANS IP20 355° 36° IRC ≥90 TRIAC ↑ A++ A 230V

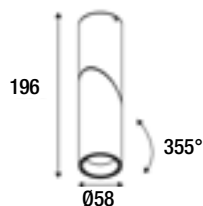

NEW

RÉF. ID	PUISSANCE	FLUX	T°	COULEUR	MATÉRIAU	PRIX HTVA
ID/03383044	11W	938 LM	3000°K	○ BLANC MAT	ALUMINIUM	€ 139,00
ID/03383043	11W	938 LM	3000°K	● NOIR MAT	ALUMINIUM	€ 139,00

SPOTS APPARENTS

GREG

LED 5 ANS IP20 90° 45° IRC >80 A++ A 230V

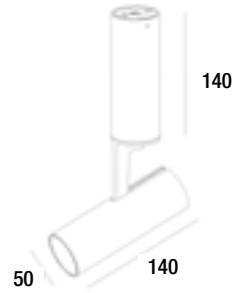

RÉF. ID	PUISSANCE	FLUX	T°	COULEUR	PRIX HTVA
ID/02325534	13W	870 LM	3000°K	○ BLANC	€ 90,00
ID/02325533	13W	870 LM	3000°K	● NOIR	€ 90,00

ROTTERDAM

LED 3 ANS IP20 85° 45° IRC >80 A++ A 230V

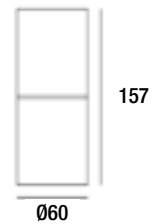

RÉF. ID	PUISSANCE	FLUX	T°	UGR	COULEUR	PRIX HTVA
ID/02517910	12W	1100 LM	3000°K	< 19	○ BLANC	€ 60,00
ID/03174633	12W	1100 LM	3000°K	< 19	● NOIR	€ 60,00

SPOTS APPARENTS

CLAC 1 MINI

LED 3 ANS IP20 90° 38° IRC >90 TRIAC ← ↑ A++ A 230V

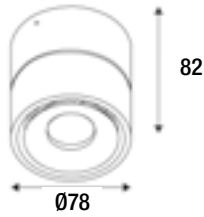

RÉF. ID	PUISSANCE	FLUX	T°	COULEUR	MATÉRIAU	PRIX HTVA
ID/02786425	8W	470 LM	3000°K	○ BLANC	ALUMINIUM	€ 105,00
ID/02786424	8W	470 LM	3000°K	● NOIR	ALUMINIUM	€ 105,00

CLAC 2 MINI

LED 3 ANS IP20 90° 38° IRC >90 TRIAC ← ↑ A++ A 230V

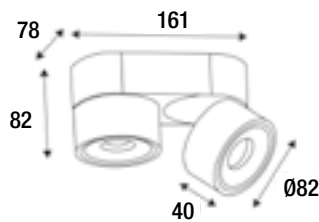

RÉF. ID	PUISSANCE	FLUX	T°	COULEUR	MATÉRIAU	PRIX HTVA
ID/02786427	2 X 8W	2 X 470 LM	3000°K	○ BLANC	ALUMINIUM	€ 150,00
ID/02786426	2 X 8W	2 X 470 LM	3000°K	● NOIR	ALUMINIUM	€ 150,00

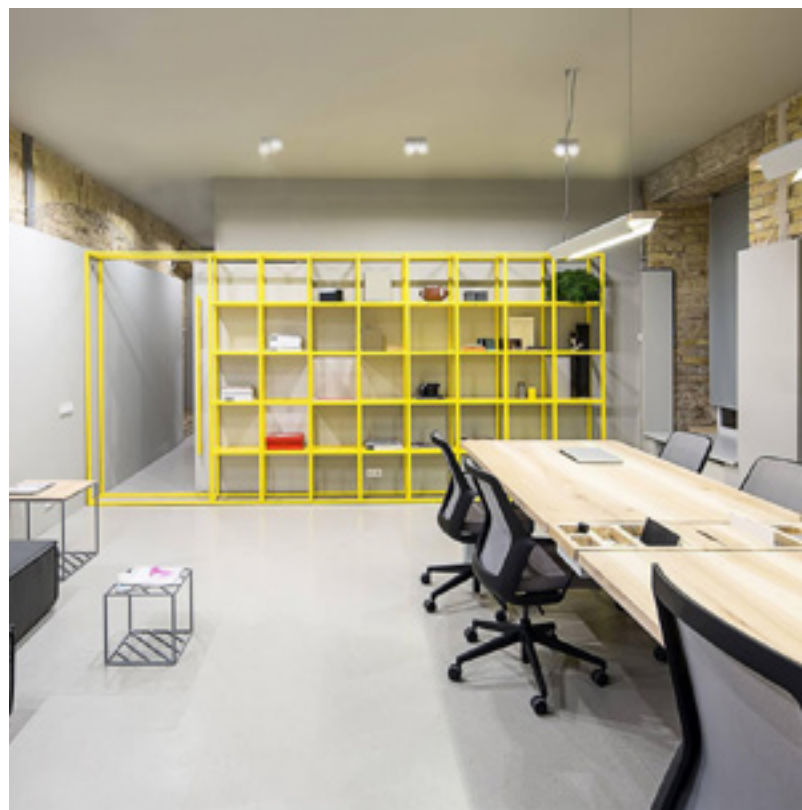

SPOTS APPARENTS

NIGEL



DIM-TO-WARM

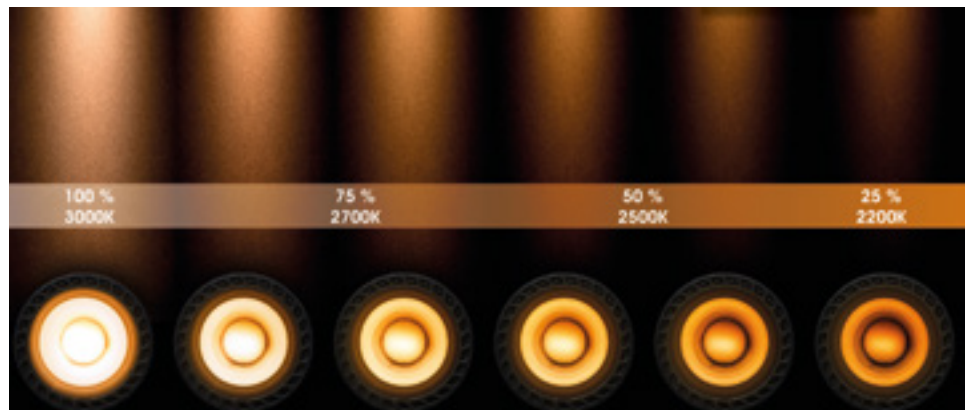

NEW

RÉF. ID	CULOT	PUISSANCE	FLUX	T°	COULEUR	DIMENSIONS MM	MATÉRIAU	PRIX HTVA
ID/03274728	1 X GU10	1 X 5W	1 X 320 LM	2200 - 3000°K	○ BLANC	120 X 100 X 100	ALUMINIUM	€ 36,00
ID/03274727	1 X GU10	1 X 5W	1 X 320 LM	2200 - 3000°K	● NOIR	120 X 100 X 100	ALUMINIUM	€ 36,00
ID/03274730	2 X GU10	2 X 5W	2 X 320 LM	2200 - 3000°K	○ BLANC	120 X 100 X 200	ALUMINIUM	€ 73,00
ID/03274729	2 X GU10	2 X 5W	2 X 320 LM	2200 - 3000°K	● NOIR	120 X 100 X 200	ALUMINIUM	€ 73,00
ID/03274732	3 X GU10	3 X 5W	3 X 320 LM	2200 - 3000°K	○ BLANC	120 X 100 X 300	ALUMINIUM	€ 107,00
ID/03274731	3 X GU10	3 X 5W	3 X 320 LM	2200 - 3000°K	● NOIR	120 X 100 X 300	ALUMINIUM	€ 107,00
ID/03274734	4 X GU10	4 X 5W	4 X 320 LM	2200 - 3000°K	○ BLANC	120 X 200 X 200	ALUMINIUM	€ 132,00
ID/03274733	4 X GU10	4 X 5W	4 X 320 LM	2200 - 3000°K	● NOIR	120 X 200 X 200	ALUMINIUM	€ 132,00

SPOTS APPARENTS

SPOTS APPARENTS

SPLIT 1/2/3

3 ANS

IP20

90°

TRIAC

A++
A

230V

230V

230V

230V

SPOTS APPARENTS

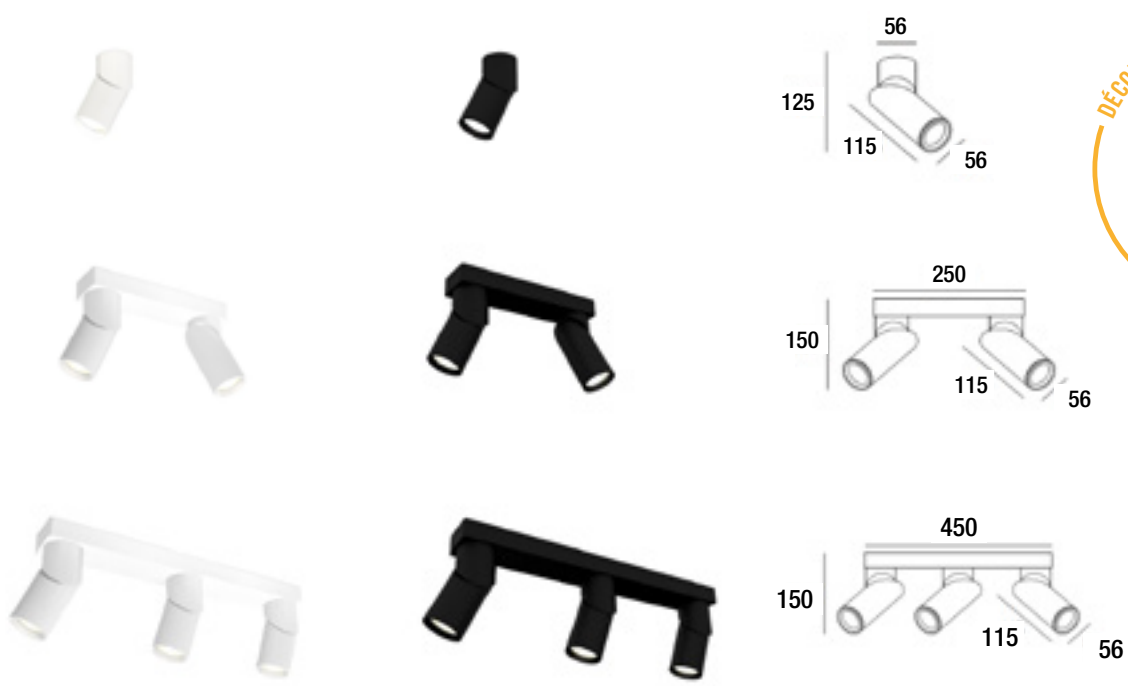

NEW

RÉF. ID	CULOT	PUISSANCE MAX	FLUX MAX	COULEUR	MATÉRIAU	PRIX HTVA
ID/03383276	1 X GU10	MAX 1 X 9W	1 X 575 LM	○ BLANC STRUCTURE	ALUMINIUM	€ 33,00
ID/03383277	1 X GU10	MAX 1 X 9W	1 X 575 LM	● NOIR STRUCTURE	ALUMINIUM	€ 33,00
ID/03383278	2 X GU10	MAX 2 X 9W	2 X 575 LM	○ BLANC STRUCTURE	ALUMINIUM	€ 66,00
ID/03383279	2 X GU10	MAX 2 X 9W	2 X 575 LM	● NOIR STRUCTURE	ALUMINIUM	€ 66,00
ID/03383280	3 X GU10	MAX 3 X 9W	3 X 575 LM	○ BLANC STRUCTURE	ALUMINIUM	€ 100,00
ID/03383281	3 X GU10	MAX 3 X 9W	3 X 575 LM	● NOIR STRUCTURE	ALUMINIUM	€ 100,00

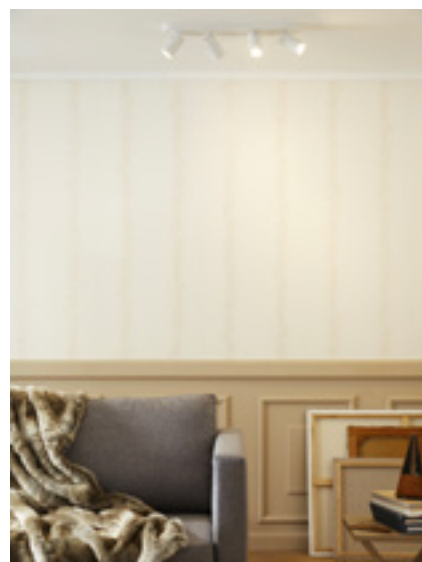
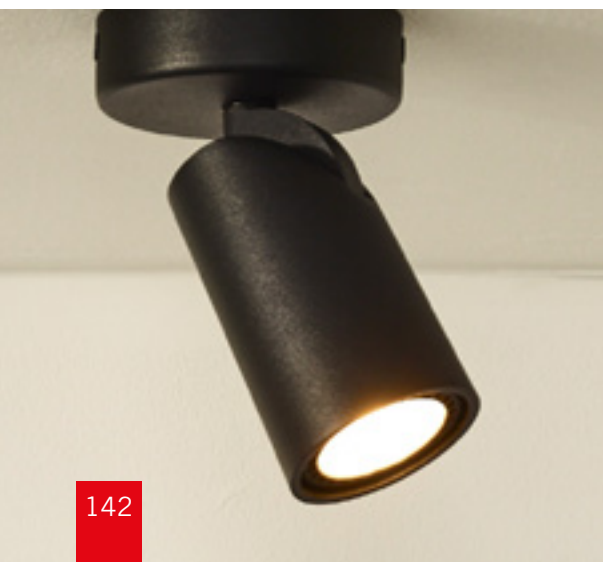

SPOTS APPARENTS

XYRUS



Le conseil de l'éclairagiste:

Augmenter la chaleur de la lumière en diminuant l'intensité lumineuse, c'est désormais possible grâce aux spots led Dim-to-Warm. Top pour créer des ambiances cocoon et chaleureuses !

RÉF. ID	CULOT	SOURCE INCULSE	FLUX	T°	COULEUR	DIMENSIONS MM	PRIX HTVA
ID/03170142	1 X GU10	1 X 5W	1 X 320 LM	2200°K- 3000°K	○ BLANC	Ø 90 X 125	€ 55,00
ID/03170141	1 X GU10	1 X 5W	1 X 320 LM	2200°K- 3000°K	● NOIR	Ø 90 X 125	€ 55,00
ID/03170144	2 X GU10	2 X 5W	2 X 320 LM	2200°K- 3000°K	○ BLANC	200 X 90 X 125	€ 106,00
ID/03170143	2 X GU10	2 X 5W	2 X 320 LM	2200°K- 3000°K	● NOIR	200 X 90 X 125	€ 106,00
ID/03170146	4 X GU10	4 X 5W	4 X 320 LM	2200°K- 3000°K	○ BLANC	600 X 90 X 125	€ 182,00
ID/03170145	4 X GU10	4 X 5W	4 X 320 LM	2200°K- 3000°K	● NOIR	600 X 90 X 125	€ 182,00
ID/03170148	6 X GU10	6 X 5W	6 X 320 LM	2200°K- 3000°K	○ BLANC	854 X 140 X 125	€ 283,00
ID/03170147	6 X GU10	6 X 5W	6 X 320 LM	2200°K- 3000°K	● NOIR	854 X 140 X 125	€ 283,00

SPOTS APPARENTS

SPOTS APPARENTS

JASTER LED



SPOTS APPARENTS

RÉF. ID	CULOT	PUISANCE	FLUX	T°	COULEUR	DIMENSIONS MM	MATÉRIAU	PRIX HTVA
ID/02227549	1 X GU10	1 X 5W	1 X 350 LM	3000°K	○ BLANC	50 X 60 X 155	MÉTAL	€ 19,00
ID/02227548	1 X GU10	1 X 5W	1 X 350 LM	3000°K	● NOIR	50 X 60 X 155	MÉTAL	€ 19,00
ID/02227551	2 X GU10	2 X 5W	2 X 350 LM	3000°K	○ BLANC	200 X 60 X 155	MÉTAL	€ 38,00
ID/02227550	2 X GU10	2 X 5W	2 X 350 LM	3000°K	● NOIR	200 X 60 X 155	MÉTAL	€ 38,00
ID/02227553	3 X GU10	3 X 5W	3 X 350 LM	3000°K	○ BLANC	∅ 200 X 155	MÉTAL	€ 56,00
ID/02227552	3 X GU10	3 X 5W	3 X 350 LM	3000°K	● NOIR	∅ 200 X 155	MÉTAL	€ 56,00
ID/02227555	4 X GU10	4 X 5W	4 X 350 LM	3000°K	○ BLANC	500 X 60 X 155	MÉTAL	€ 74,00
ID/02227554	4 X GU10	4 X 5W	4 X 350 LM	3000°K	● NOIR	500 X 60 X 155	MÉTAL	€ 74,00

SPOTS APPARENTS

RILOU



NEW

RÉF. ID	CULOT	PUISSANCE	FLUX	T°	COULEUR	DIMENSIONS MM	MATÉRIAU	PRIX HTVA
ID/01610081	1 X GU10	1 X 5W	1 X 320 LM	3000°K	○ BLANC MAT	150 X 100 X 100	MÉTAL	€ 37,00
ID/01610082	2 X GU10	2 X 5W	2 X 320 LM	3000°K	○ BLANC MAT	150 X 90 X 300	MÉTAL	€ 59,00
ID/01610083	3 X GU10	3 X 5W	3 X 320 LM	3000°K	○ BLANC MAT	150 X 90 X 440	MÉTAL	€ 90,00
ID/01610084	4 X GU10	4 X 5W	4 X 320 LM	3000°K	○ BLANC MAT	150 X 260 X 260	MÉTAL	€ 128,00

TURNON

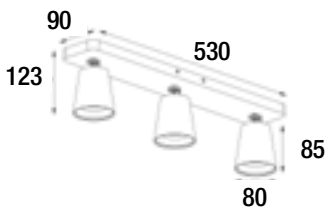
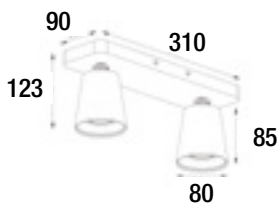

NEW

RÉF. ID	CULOT	PUISSANCE	FLUX	T°	COULEUR	MATÉRIAU	PRIX HTVA
ID/03274725	2 X GU10	2 X 5W	2 X 320 LM	2200 - 3000°K	● NOIR/DORE	ALUMINIUM	€ 73,00
ID/03274726	3 X GU10	3 X 5W	3 X 320 LM	2200 - 3000°K	● NOIR/DORE	ALUMINIUM	€ 107,00

SPOTS APPARENTS

SPOTS APPARENTS

NYSIT

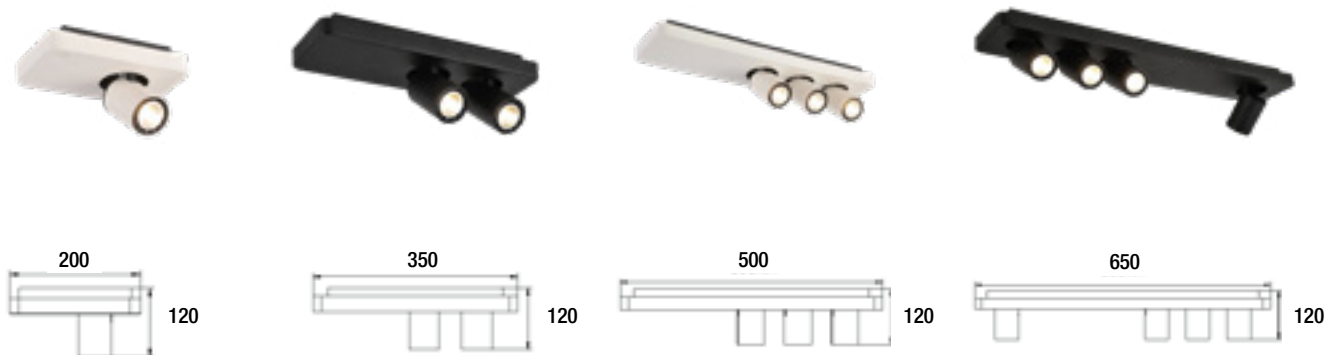

SPOTS APPARENTS

RÉF. ID	CULOT	SOURCE INCLUSE	FLUX	T°	COULEUR	MATÉRIAU	PRIX HTVA
ID/02878461	1 X GU10	1 X 4,5W	1 X 380 LM	2700°K	○ BLANC	ALU / ACIER	€ 66,00
ID/02878465	1 X GU10	1 X 4,5W	1 X 380 LM	2700°K	● NOIR	ALU / ACIER	€ 66,00
ID/02878462	2 X GU10	2 X 4,5W	2 X 380 LM	2700°K	○ BLANC	ALU / ACIER	€ 112,00
ID/02878466	2 X GU10	2 X 4,5W	2 X 380 LM	2700°K	● NOIR	ALU / ACIER	€ 112,00
ID/02878463	3 X GU10	3 X 4,5W	3 X 380 LM	2700°K	○ BLANC	ALU / ACIER	€ 170,00
ID/02878467	3 X GU10	3 X 4,5W	2 X 380 LM	2700°K	● NOIR	ALU / ACIER	€ 170,00
ID/02878464	4 X GU10	4 X 4,5W	4 X 380 LM	2700°K	○ BLANC	ALU / ACIER	€ 220,00
ID/02878468	4 X GU10	4 X 4,5W	4 X 380 LM	2700°K	● NOIR	ALU / ACIER	€ 220,00



SPOTS APPARENTS

LOPAL NEW

LED IP20 35° IRC >90 TRIAC ↑ A++ A 230V

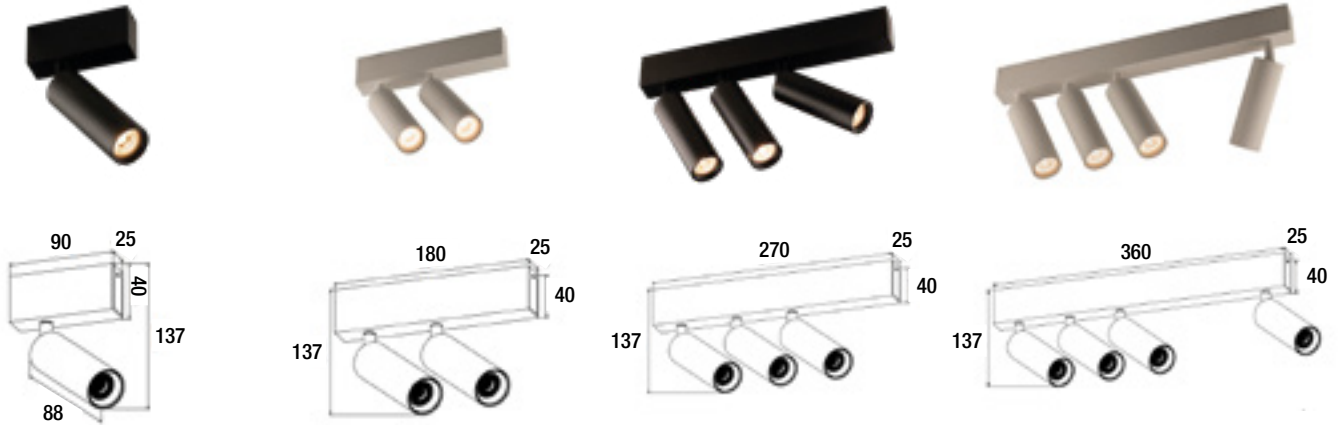

RÉF. ID	PUISSANCE	FLUX	T°	COULEUR	PRIX HTVA
ID/02879153	1 X 4W	1 X 360 LM	2700°K	○ BLANC	€ 44,00
ID/02879159	1 X 4 W	1 X 360LM	2700°K	● NOIR MAT	€ 44,00
ID/02879154	2 X 4W	2 X 360 LM	2700°K	○ BLANC	€ 80,00
ID/02879160	2 X 4 W	2 X 360LM	2700°K	● NOIR MAT	€ 80,00
ID/02879155	3 X 4W	3 X 360 LM	2700°K	○ BLANC	€ 120,00
ID/02879161	3 X 4 W	3 X 360LM	2700°K	● NOIR MAT	€ 120,00
ID/02879156	4 X 4W	4 X 360 LM	2700°K	○ BLANC	€ 160,00
ID/02879162	4 X 4 W	4 X 360LM	2700°K	● NOIR MAT	€ 160,00



SPOTS APPARENTS

SPOTS APPARENTS

NAULA SPOT 40



COMPOSEZ VOTRE LUMINAIRE



Le conseil de l'éclairagiste:

Pouvoir composer son luminaire en fonction de ses besoins et de ses envies, cela permet de trouver une réponse fonctionnelle et stylistiquement cohérente, surtout dans de grands espaces de vie comme un salon-cuisine-salle à manger, par exemple, dans lesquels vous pourrez créer différentes combinaisons/versions.

RÉF. ID	PUISSANCE	FLUX	T°	COULEUR	PRIX HTVA
ID/02609984	9,2W	750 LM	2700°K	○ BLANC	€ 53,00
ID/02609978	9,2W	750 LM	2700°K	● NOIR	€ 53,00
ID/02609985	9,2W	750 LM	3000°K	○ BLANC	€ 53,00
ID/02609979	9,2W	750 LM	3000°K	● NOIR	€ 53,00

NAULA 40 ACCESSOIRES



RÉF. ID	DIAMÈTRE MM	COULEUR	PRIX HTVA
ID/02609976	Ø 40	○ BLANC	€ 6,00
ID/02609975	Ø 40	● OR	€ 6,00
ID/02609974	Ø 40	● NOIR	€ 6,00

NAULA SPOT 60



COMPOSEZ VOTRE LUMINAIRE



- À combiner avec une base Naula

RÉF. ID	PUISSANCE	FLUX	T°	COULEUR	PRIX HTVA
ID/02610005	9,2W	750 LM	2700°K	○ BLANC	€ 58,00
ID/02609999	9,2W	750 LM	2700°K	● NOIR	€ 58,00
ID/02610006	9,2W	750 LM	3000°K	○ BLANC	€ 58,00
ID/02610000	9,2W	750 LM	3000°K	● NOIR	€ 58,00

Disponible en suspension page 154

NAULA 60 ACCESSOIRES



RÉF. ID	DIAMÈTRE MM	COULEUR	PRIX HTVA
ID/02609996	Ø 60	○ BLANC	€ 6,00
ID/02609994	Ø 60	● OR	€ 6,00
ID/02609992	Ø 60	● NOIR	€ 6,00

NAULA BASE RONDE



RÉF. ID	PUISSANCE	COULEUR	DIMENSIONS MM	PRIX HTVA
ID/02609956	1 X 10W	○ BLANC	Ø 100 X 28	€ 71,00
ID/02609954	1 X 10W	● NOIR	Ø 100 X 28	€ 71,00
ID/02609971	3 X 10W	○ BLANC	Ø 260 X 37	€ 126,00
ID/02609968	3 X 10W	● NOIR	Ø 260 X 37	€ 126,00

NAULA BASE CARRÉE



RÉF. ID	PUISSANCE	COULEUR	DIMENSIONS MM	PRIX HTVA
ID/02609967	2 X 10W	○ BLANC	160 X 160 X 35	€ 95,00
ID/02609964	2 X 10W	● NOIR	160 X 160 X 35	€ 95,00
ID/02609991	4 X 10W	○ BLANC	320 X 160 X 35	€ 168,00
ID/02609990	4 X 10W	● NOIR	320 X 160 X 35	€ 168,00

SPOTS APPARENTS

NAULA BASE LINÉAIRE ASYMÉTRIQUE

5
ANS

IP20

TRIAC

↑

230V



RÉF. ID	PUISSANCE	COULEUR	DIMENSIONS MM	PRIX HTVA
ID/02609957	1 X 10W	○ BLANC	175 X 50 X 40	€ 71,00
ID/02609955	1 X 10W	● NOIR	175 X 50 X 40	€ 71,00
ID/02609965	2 X 10 W	○ BLANC	360 X 50 X 40	€ 95,00
ID/02609962	2 X 10 W	● NOIR	360 X 50 X 40	€ 95,00
ID/02609972	3 X 10 W	○ BLANC	560 X 50 X 40	€ 126,00
ID/02609969	3 X 10 W	● NOIR	560 X 50 X 40	€ 126,00

NAULA BASE LINÉAIRE SYMÉTRIQUE

5
ANS

IP20

TRIAC

↑

230V



RÉF. ID	PUISSANCE	COULEUR	DIMENSIONS MM	PRIX HTVA
ID/02609966	2 X 10 W	○ BLANC	360 X 50 X 40	€ 95,00
ID/02609963	2 X 10 W	● NOIR	360 X 50 X 40	€ 95,00
ID/02609973	3 X 10 W	○ BLANC	560 X 50 X 40	€ 126,00
ID/02609970	3 X 10 W	● NOIR	560 X 50 X 40	€ 126,00



SPOTS APPARENTS





SUSPENSIONS

PAGES 152 À 193

Choisir une suspension, ce n'est pas tant éclairer un espace que de lui donner une touche déco qui reflète vos goûts et votre personnalité.



SUSPENSIONS

 NAULA 40 154	 NAULA 60 155	 NEW NOIA 156	 SCOPE 157	 NEW LORENZ 158	 NEW MARGARY 158	 NEW TUBULE 159	 NEW SELIN 159	 NEW ODREY 1 160
 NEW LESTER 162	 NEW LEANNE 163	 NEW TANNER 164	 ARTHUR 165	 THOR 166	 ORIS 167	 RICKY 168	 MANUELA 168	 BOUNDE 169
 BODO 169	 ETTA 170	 JULIUS 171	 ORRIN 172	 DELTA 174	 NEW BASE RONDE 176	 NEW BASE LINEAIRE 177	 NEW TOKYO 178	 TALOWE 179
 BOA 180	 TRINITI 181	 NEW GURI 182	 ENIMA SUSPENSION 182	 PURE LINE 183	 SIGMA 184	 RAYA 185	 SYTZE 185	 NEW IZAK 186
 NEW DARF 1 187	 RODA P 188	 SULLY P 188	 OZORA 189	 PROLINE ROW 1 189	 TRIMLESS 190	 LEDLINER 35 191	 NEW INDIVILED 192	

SUSPENSIONS

NAULA 40



COMPOSEZ VOTRE LUMINAIRE

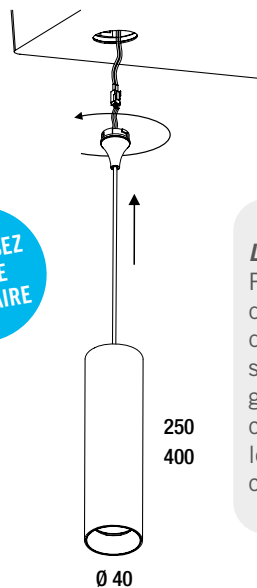

- À combiner avec une base Naula voir p. 149 - 150
- Câble de 1500 mm

Le conseil de l'éclairagiste:

Pouvoir composer son luminaire en fonction de ses besoins et de ses envies, cela permet de trouver une réponse fonctionnelle et stylistiquement cohérente, surtout dans de grands espaces de vie comme un salon-cuisine-salle à manger, par exemple, dans lesquels vous pourrez créer différentes combinaisons/versions.

RÉF. ID	PUISSANCE	FLUX	T°	COULEUR	DIMENSIONS MM	PRIX HTVA
ID/02609986	9,2 W	750 LM	2700°K	○ BLANC	Ø 40 X 250	€ 79,00
ID/02609980	9,2 W	750 LM	2700°K	● NOIR	Ø 40 X 250	€ 79,00
ID/02609987	9,2 W	750 LM	3000°K	○ BLANC	Ø 40 X 250	€ 79,00
ID/02609981	9,2 W	750 LM	3000°K	● NOIR	Ø 40 X 250	€ 79,00
ID/02609988	9,2 W	750 LM	2700°K	○ BLANC	Ø 40 X 400	€ 89,00
ID/02609982	9,2 W	750 LM	2700°K	● NOIR	Ø 40 X 400	€ 89,00
ID/02609989	9,2 W	750 LM	3000°K	○ BLANC	Ø 40 X 400	€ 89,00
ID/02609983	9,2 W	750 LM	3000°K	● NOIR	Ø 40 X 400	€ 89,00

Disponible en spots apparents page 148

NAULA 40 BAGUES DE FINITION (OPTION)



RÉF. ID	DIAMÈTRE MM	COULEUR	PRIX HTVA
ID/02609976	Ø 40	○ BLANC	€ 6,00
ID/02609975	Ø 40	● OR	€ 6,00
ID/02609974	Ø 40	● NOIR	€ 6,00

NAULA 60



COMPOSEZ VOTRE LUMINAIRE

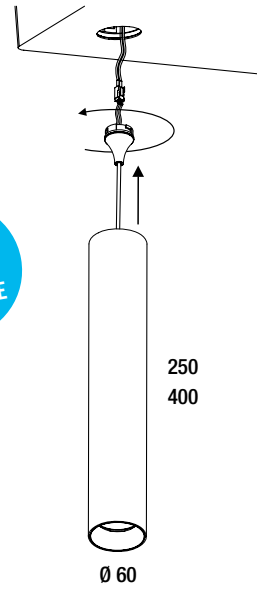

- À combiner avec une base Naula voir p. 149 - 150
- Câble de 1500 mm

SUSPENSIONS

RÉF. ID	PUISSANCE	FLUX	T°	COULEUR	DIMENSIONS MM	PRIX HTVA
ID/02610007	9,2 W	750 LM	2700°K	○ BLANC	Ø 60 X 250	€ 84,00
ID/02610001	9,2 W	750 LM	2700°K	● NOIR	Ø 60 X 250	€ 84,00
ID/02610008	9,2 W	750 LM	3000°K	○ BLANC	Ø 60 X 250	€ 84,00
ID/02610002	9,2 W	750 LM	3000°K	● NOIR	Ø 60 X 250	€ 84,00
ID/02610009	9,2 W	750 LM	2700°K	○ BLANC	Ø 60 X 400	€ 95,00
ID/02610003	9,2 W	750 LM	2700°K	● NOIR	Ø 60 X 400	€ 95,00
ID/02610010	9,2 W	750 LM	3000°K	○ BLANC	Ø 60 X 400	€ 95,00
ID/02610004	9,2 W	750 LM	3000°K	● NOIR	Ø 60 X 400	€ 95,00

NAULA 60 BAGUES DE FINITION (OPTION)



RÉF. ID	DIAMÈTRE MM	COULEUR	PRIX HTVA
ID/02609996	Ø 60	○ BLANC	€ 6,00
ID/02609994	Ø 60	● OR	€ 6,00
ID/02609992	Ø 60	● NOIR	€ 6,00

SUSPENSIONS

NOIA

3 ANS

IP20



TRIAC



A++
A

230V



Conçue pour recevoir une lampe GU10, Noia est aussi belle seule qu'en groupe de plusieurs dimensions différentes. Elle permet ainsi à votre imagination de créer des compositions sans fins, selon vos envies.

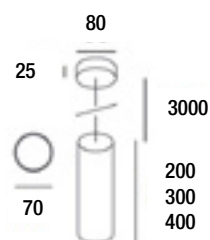

NEW

RÉF. ID	CULOT	PUISSANCE MAX	FLUX MAX	COULEUR	DIMENSIONS MM	MATÉRIAU	PRIX HTVA
ID/03383270	GU10	MAX 9W	575 LM	○ BLANC STRUCTURE	Ø 70 X 200	ALUMINIUM	€ 55,00
ID/03383271	GU10	MAX 9W	575 LM	● NOIR STRUCTURE	Ø 70 X 200	ALUMINIUM	€ 55,00
ID/03383272	GU10	MAX 9W	575 LM	○ BLANC STRUCTURE	Ø 70 X 300	ALUMINIUM	€ 64,00
ID/03383273	GU10	MAX 9W	575 LM	● NOIR STRUCTURE	Ø 70 X 300	ALUMINIUM	€ 64,00
ID/03383274	GU10	MAX 9W	575 LM	○ BLANC STRUCTURE	Ø 70 X 400	ALUMINIUM	€ 72,00
ID/03383275	GU10	MAX 9W	575 LM	● NOIR STRUCTURE	Ø 70 X 400	ALUMINIUM	€ 72,00

SCOPE

LED 3 ANS IP20 40° IRC >90 TRIAC ↑ A++ A 230V

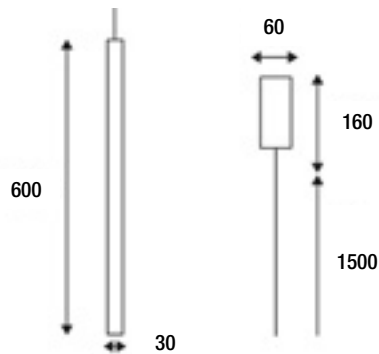

- Livrée avec câble d'alimentation 1.50m max
- Convertisseur dimmable intégré dans la base.
- Compatible avec variateur début et fin de phase.

Le conseil de l'éclairagiste:

Une suspension longiligne souligne la hauteur sous-plafond d'une pièce; elle l'étire.



RÉF. ID	PUISSANCE	FLUX	T°	COULEUR	DIMENSIONS MM	PRIX HTVA
ID/02682236	7,5W	370 LM	3000°K	○ BLANC	Ø 30 X 600	€ 165,00
ID/02682234	7,5W	370 LM	3000°K	● NOIR	Ø 30 X 600	€ 165,00
ID/02682235	7,5W	370 LM	3000°K	● BRONZE ANTIQUE	Ø 30 X 600	€ 165,00

SUSPENSIONS

LORENZ

LED 3 ANS IP20 IRC 80 A++ A 230V

- Câbles entourés de tissus

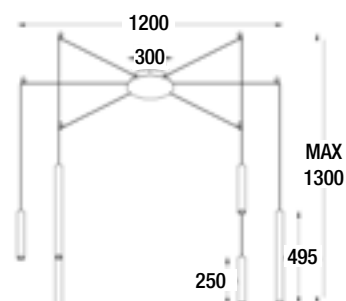
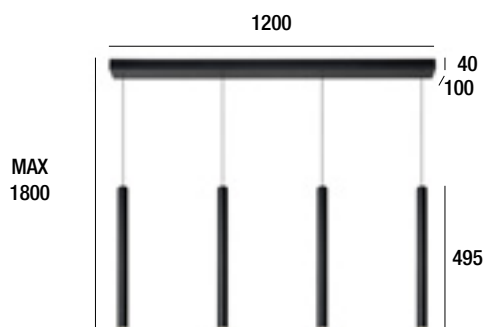

SUSPENSIONS

NEW

RÉF. ID	PUISSANCE	FLUX	T°	COULEUR	MATÉRIAU	PRIX HTVA
ID/03170195	4 X 4W	4 X 100 LM	3000°K	● NOIR	ALUMINIUM	€ 190,00
ID/03170196	4 X 4W	4 X 100 LM	3000°K	● CUIVRE SATINÉ	ALUMINIUM	€ 190,00
ID/03170197	6 X 4W	6 X 100 LM	3000°K	● NOIR MAT	ALUMINIUM	€ 240,00
ID/03170198	6 X 4W	6 X 100 LM	3000°K	● CUIVRE SATINÉ	ALUMINIUM	€ 240,00

MARGARY

LED 3 ANS IP20 IRC 80 A++ A 230V

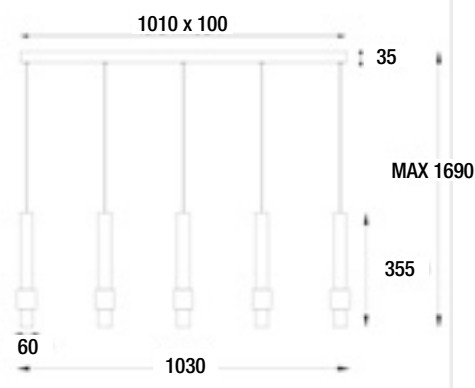
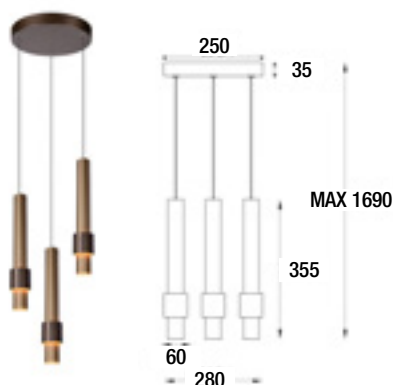

NEW

RÉF. ID	PUISSANCE	FLUX	T°	COULEUR	MATÉRIAU	PRIX HTVA
ID/03382628	3 X 5W	3 X 100 LM	2700°K	● CAFE/DORE/LAITON	ALUMINIUM	€ 140,00
ID/03382629	5 X 5W	5 X 100 LM	2700°K	● CAFE/DORE/LAITON	ALUMINIUM	€ 248,00

TUBULE

LED 3 ANS IP20 IRC 80 A++ A 230V



Parfaitement dans la tendance actuelle, Tubule propose un design sobre, minimaliste tout en fournissant un éclairage chaleureux.

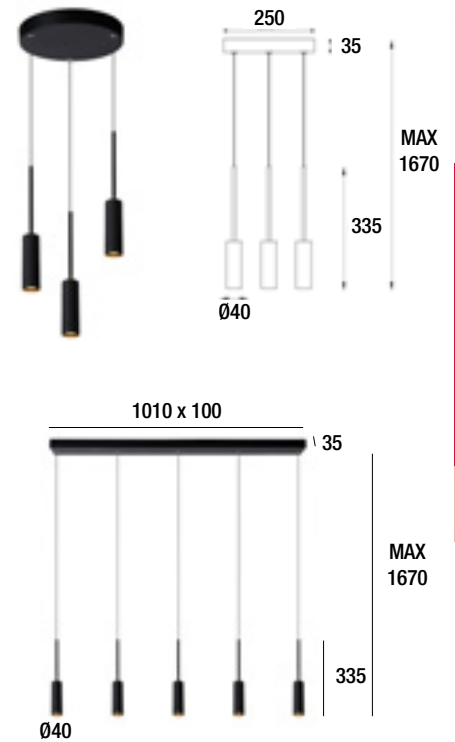

NEW

RÉF. ID	PUISSANCE	FLUX	T°	COULEUR	MATÉRIAU	PRIX HTVA
ID/03382630	3 X 7W	3 X 200 LM	2700°K	● NOIR	ALUMINIUM	€ 116,00
ID/03382631	5 X 7W	5 X 200 LM	2700°K	● NOIR	ALUMINIUM	€ 207,00

SELIN

IP20 TRIAC A++ A 230V

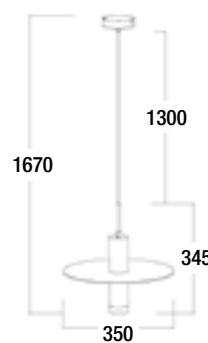

La suspension Selin respire la simplicité et l'élégance. Cette lampe rétro-chic avec une touche dorée saura parfaitement s'intégrer dans n'importe quel type d'intérieur.



NEW

RÉF. ID	CULOT	PUISSANCE MAX	FLUX MAX	COULEUR	MATÉRIAU	PRIX HTVA
ID/03170075	GU10	MAX 9W	575 LM	● NOIR/LAITON	MÉTAL	€ 95,00

SUSPENSIONS

ODREY 1



230V



Large famille composée de suspensions et d'appliques, Odrey propose une multitude d'abats-jours dans des coloris or ou noir. Idéal pour créer des compositions originales.

- Base plafond à commander séparément
- Peut être combiné avec les bases p.176 - 177



SUSPENSIONS

NEW

RÉF. ID	CULOT	PUISSANCE MAX	FLUX MAX	COULEUR	MATÉRIAU	PRIX HTVA
ID/03361712	GU10	MAX 9W	575 LM	● NOIR	ALUMINIUM	€ 73,00
ID/03361713	GU10	MAX 9W	575 LM	● OR	ALUMINIUM	€ 73,00
ID/02229567		BASE PLAFOND BLANCHE POUR 1 SUSPENSION				€ 16,50
ID/02229568		BASE PLAFOND NOIRE POUR 1 SUSPENSION				€ 16,50

*Disponible en applique page 210
Disponible sur tracklight page 254*

ODREY INNER COVER 1.0 (OPTIONNEL)

- Compatible avec les Odrey shade 6.0, 7.0 et 8.0



SHADE 8.0
+ INNER COVER

NEW

RÉF. ID	COULEUR	MATÉRIAU	PRIX HTVA
ID/03361714	● NOIR	ALUMINIUM	€ 26,00
ID/03361715	● OR	ALUMINIUM	€ 26,00

ODREY SHADE (REQUIS)



SHADE 1.0



SHADE 2.0



SHADE 3.0



SHADE 4.0



SHADE 5.0



SHADE 6.0



SHADE 7.0



SHADE 8.0

NEW

RÉF. ID	FORME	COULEUR	DIMENSIONS MM	MATÉRIAU	PRIX HTVA
ID/03361718	SHADE 1.0	● NOIR	Ø 55 X 50	ALUMINIUM	€ 31,00
ID/03361719	SHADE 1.0	● OR	Ø 55 X 50	ALUMINIUM	€ 31,00
ID/03598529	SHADE 2.0	● NOIR + INNER COVER ● NOIR	Ø 250 X 44	ALUMINIUM	€ 88,00
ID/03598528	SHADE 2.0	● NOIR + INNER COVER ● OR	Ø 250 X 44	ALUMINIUM	€ 88,00
ID/03598526	SHADE 2.0	● OR + INNER COVER ● OR	Ø 250 X 44	ALUMINIUM	€ 88,00
ID/03598527	SHADE 2.0	● OR + INNER COVER ● NOIR	Ø 250 X 44	ALUMINIUM	€ 88,00
ID/03361722	SHADE 3.0	● NOIR	Ø 100 X 85	ALUMINIUM	€ 27,00
ID/03361723	SHADE 3.0	● OR	Ø 100 X 85	ALUMINIUM	€ 27,00
ID/03361724	SHADE 4.0	● NOIR	Ø 124 X 120	ALUMINIUM	€ 37,00
ID/03361725	SHADE 4.0	● OR	Ø 124 X 120	ALUMINIUM	€ 37,00
ID/03361726	SHADE 5.0	● NOIR	Ø 115 X 160	ALUMINIUM	€ 49,00
ID/03361727	SHADE 5.0	● OR	Ø 115 X 160	ALUMINIUM	€ 49,00
ID/03361728	SHADE 6.0	● NOIR	Ø 190 X 75	ALUMINIUM	€ 39,00
ID/03361729	SHADE 6.0	● OR	Ø 190 X 75	ALUMINIUM	€ 39,00
ID/03361730	SHADE 7.0	● NOIR	Ø 150 X 50	ALUMINIUM	€ 41,00
ID/03361731	SHADE 7.0	● OR	Ø 150 X 50	ALUMINIUM	€ 41,00
ID/03361732	SHADE 8.0	● NOIR	Ø 250 X 50	ALUMINIUM	€ 63,00
ID/03361733	SHADE 8.0	● OR	Ø 250 X 50	ALUMINIUM	€ 63,00



SUSPENSIONS

LESTER



230V



SUSPENSIONS

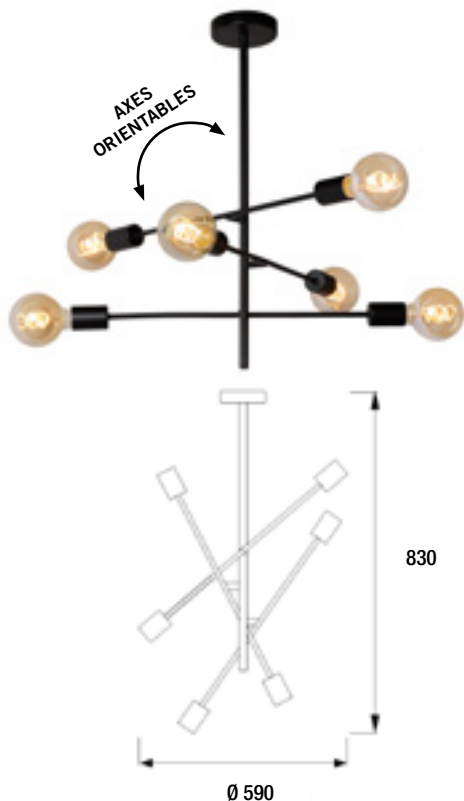

MAX
1770

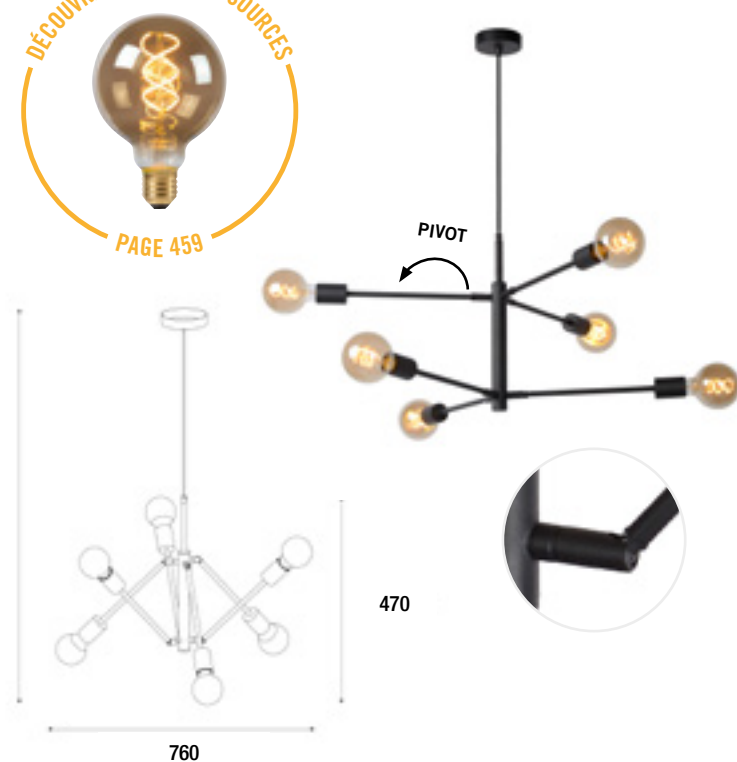

RÉF. ID	CULOT	PUISSANCE MAX	FLUX MAX	COULEUR	DIMENSIONS MM	MATÉRIAU	PRIX HTVA
ID/02772924	6 X E27	MAX 6 X 9W	6 X 800 LM	● NOIR	Ø 590 X 830	MÉTAL	€ 56,00
ID/03382621	6 X E27	MAX 6 X 9W	6 X 800 LM	● NOIR	Ø 760 X 470	MÉTAL	€ 60,00

LEANNE



230V



SUSPENSIONS

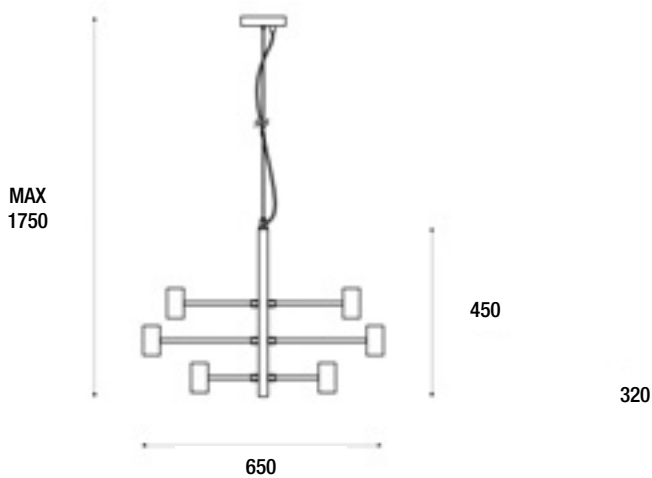

Le conseil de l'éclairagiste:

Opter pour une suspension avec culot(s) E27, c'est se permettre d'adapter son flux lumineux ainsi que de varier l'esthétique générale du luminaire en l'équipant d'une ampoule décorative de son choix.

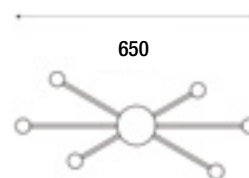

NEW

RÉF. ID	CULOT	PUISSANCE MAX	FLUX MAX	COULEUR	MATÉRIAU	PRIX HTVA
ID/03170132	6 X E27	MAX 6 X 9W	6 X 800 LM	● NOIR	MÉTAL	€ 83,00

SUSPENSIONS

TANNER



230V



Avec une finition béton ou bois, Tanner apporte une touche de modernité à votre intérieur. Placez-y une source lumineuse déco et l'effet sera maximal.

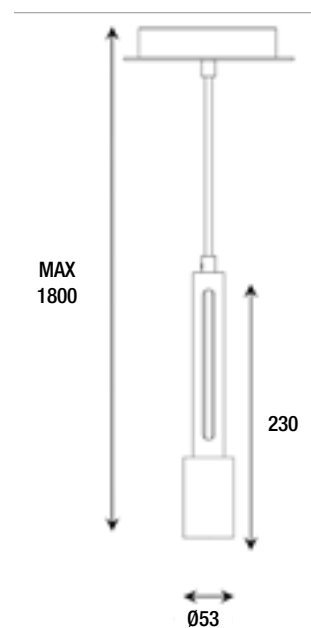

NEW

RÉF. ID	CULOT	PUISSANCE MAX	FLUX MAX	COULEUR	MATÉRIAU	PRIX HTVA
ID/03382659	E27	MAX 9W	800 LM	● NOIR/GRIS	ALUMINIUM/BETON	€ 29,00
ID/03382660	E27	MAX 9W	800 LM	● NOIR/BOIS	ALUMINIUM/BOIS	€ 30,00

Disponible en applique page 203
Disponible en lampe à poser page 229

ARTHUR



230V

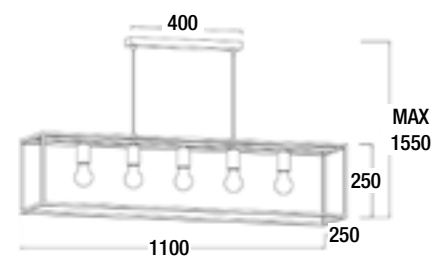
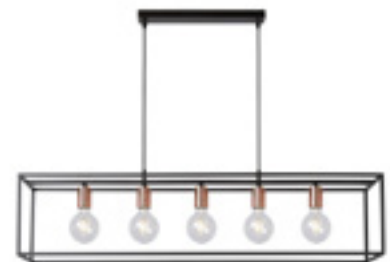
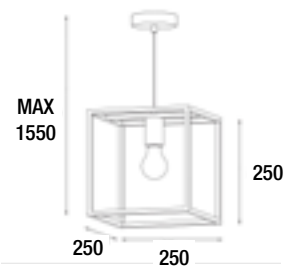

SUSPENSIONS



RÉF. ID	CULOT	PUISSANCE MAX	FLUX MAX	COULEUR	PRIX HTVA
ID/02611983	1 X E27	MAX 1 X 9W	1 X 800 LM	● NOIR / CUIVRE ●	€ 40,00
ID/02611984	5 X E27	MAX 5 X 9W	5 X 800 LM	● NOIR / CUIVRE ●	€ 132,00

Disponible en plafonnier page 120
 Disponible en applique page 206
 Disponible en lampe à poser page 230

SUSPENSIONS

THOR

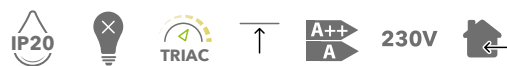

SUSPENSIONS

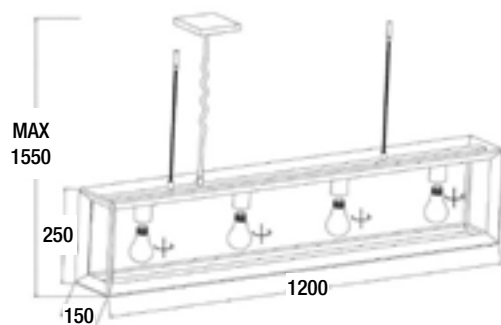

RÉF. ID	CULOT	PUISSANCE MAX	FLUX MAX	COULEUR	PRIX HTVA
ID/02612163	4 X E27	4 X 9W	4 X 800 LM	● GRIS FER ANTIQUE	€ 207,00

Disponible en plafonnier page 121
 Disponible en applique page 207
 Disponible en lampe à poser page 231

ORIS



230V

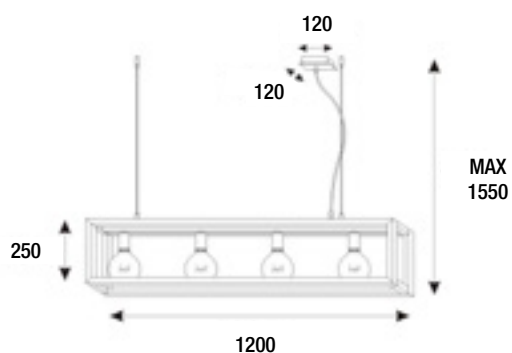
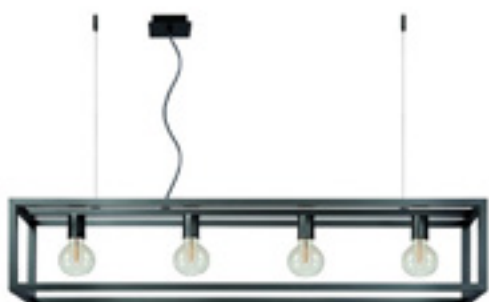

SUSPENSIONS



RÉF. ID	CULOT	PUISSANCE MAX	FLUX MAX	COULEUR	PRIX HTVA
ID/02085433	4 X E27	4 X 9W	4 X 800 LM	● GRAPHITE	€ 309,00
ID/02227749	4 X E27	4 X 9W	4 X 800 LM	● BOIS NATUREL	€ 309,00

SUSPENSIONS

RICKY



230V



390



min 600
max 1600

375

RÉF. ID	CULOT	PUISSANCE MAX	FLUX MAX	COULEUR	PRIX HTVA
ID/01609893	E27	MAX 9W	800 LM	● NOIR	€ 62,00
ID/01609892	E27	MAX 9W	800 LM	● CUIVRE	€ 62,00

MANUELA



230V



420

Ø 500



520

Ø 650



RÉF. ID	CULOT	PUISSANCE MAX	FLUX MAX	COULEUR	DIMENSIONS MM	PRIX HTVA
ID/02325626	E27	MAX 9W	800 LM	● NOIR	Ø 500 X 420 X 1720	€ 132,00
ID/02227889	E27	MAX 9W	800 LM	● NOIR	Ø 650 X 520 X 1820	€ 165,00
ID/02325625	E27	MAX 9W	800 LM	● CUIVRE	Ø 500 X 420 X 1720	€ 157,00
ID/02227888	E27	MAX 9W	800 LM	● CUIVRE	Ø 650 X 520 X 1820	€ 182,00

Disponible en plafonnier page 120

BOUNDE

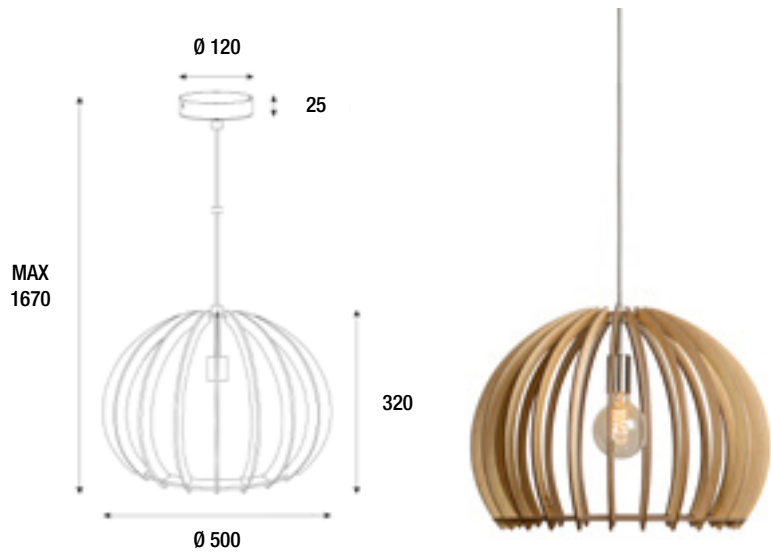

RÉF. ID	CULOT	PUISSANCE MAX	FLUX MAX	COULEUR	DIMENSIONS MM	PRIX HTVA
ID/01908816	E27	MAX 9W	800 LM	● BOIS NATUREL	Ø 500 X 500 X 1670	€ 182,00



BODO

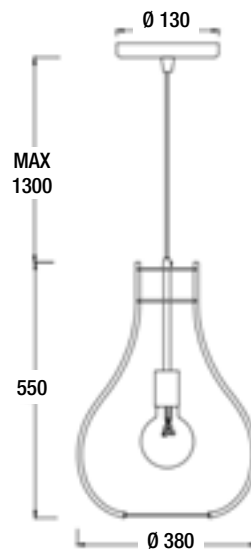

Bodo combine des matériaux naturels avec un design apaisant. L'utilisation du bois dans cette version contemporaine se rapproche des tendances scandinaves. Le beau jeu de formes fines en bois courbé combinées avec l'espace ouvert sauront créer une ambiance moderne.

RÉF. ID	CULOT	PUISSANCE MAX	FLUX MAX	COULEUR	PRIX HTVA
ID/02085330	E27	MAX 9W	800 LM	● BOIS NATUREL	€ 248,00

SUSPENSIONS

ETTA



230V



SUSPENSIONS

RÉF. ID	CULOT	PUISSANCE MAX	FLUX MAX	COULEUR	DIMENSIONS MM	PRIX HTVA
ID/02612097	E27	MAX 9W	800 LM	● BOIS NATUREL	Ø 290 X 160 X 1460	€ 50,00
ID/02612099	E27	MAX 9W	800 LM	● BOIS NATUREL	Ø 390 X 220 X 1520	€ 66,00



JULIUS

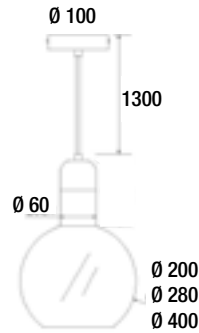

Le conseil de l'éclairagiste:

Une famille de luminaires déclinés dans différentes tailles et compositions constitue une solution d'éclairage pratique pour obtenir une belle cohérence de style, surtout dans le cas de grands espaces de vie ouverts avec plusieurs points d'éclairage.



NEW

RÉF. ID	CULOT	PUISSANCE MAX	FLUX MAX	COULEUR	DIMENSIONS MM	MATÉRIAU	PRIX HTVA
ID/02772939	1 X E27	1 X MAX 9W	1 X 800 LM	● VERRE FUME	Ø 200 X 1500	MÉTAL/VERRE	€ 48,00
ID/02772940	1 X E27	1 X MAX 9W	1 X 800 LM	● VERRE FUME	Ø 280 X 1580	MÉTAL/VERRE	€ 72,00
ID/02772941	1 X E27	1 X MAX 9W	1 X 800 LM	● VERRE FUME	Ø 400 X 1700	MÉTAL/VERRE	€ 97,00
ID/03382649	3 X E27	3 X MAX 9W	3 X 800 LM	● VERRE FUME	1650 X 270 X 1050	MÉTAL/VERRE	€ 198,00
ID/03382650	5 X E27	5 X MAX 9W	5 X 800 LM	● VERRE FUME	Ø 500 X 1500	MÉTAL/VERRE	€ 372,00

SUSPENSIONS

ORRIN



230V



SUSPENSIONS

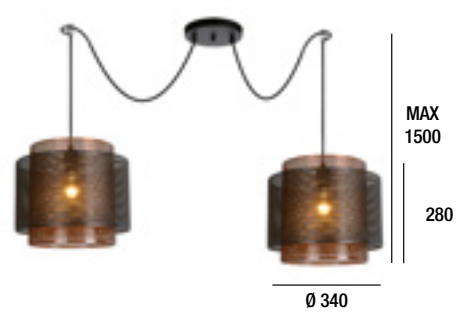
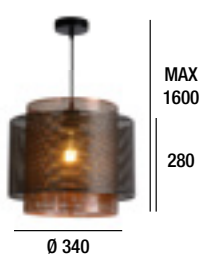

RÉF. ID	CULOT	PUISSANCE MAX	FLUX MAX	COULEUR	PRIX HTVA
ID/02695324	1 X E27	1 X MAX 9W	1 X 800 LM	● NOIR & CUIVRE	€ 63,00
ID/02695325	2 X E27	2 X MAX 9W	2 X 800 LM	● NOIR & CUIVRE	€ 124,00
ID/02695326	3 X E27	3 X MAX 9W	3 X 800 LM	● NOIR & CUIVRE	€ 128,00

Disponible en lampe à poser page 232



SUSPENSIONS

DELTA

LED 3 ANS IP20 IRC >80    230V 



SUSPENSIONS



- Diffuseur en PMMA
- Livrée avec câble d'alimentation textile blanc réglable 1.50m max
- Convertisseur non dimmable intégré dans la base

RÉF. ID	PUISSANCE	FLUX	T°	COULEUR	PRIX HTVA
ID/01872492	24W	1330 LM	3000°K	○ BLANC	€ 196,00
ID/02786404	24W	1330 LM	3000°K	● GRIS	€ 196,00
ID/02786405	24W	1330 LM	3000°K	● JAUNE	€ 196,00
ID/02786406	24W	1330 LM	3000°K	● VERT	€ 196,00
ID/02786407	24W	1330 LM	3000°K	● ROSE	€ 196,00
ID/02786408	24W	1330 LM	3000°K	● VERT CLAIR	€ 196,00
ID/02786409	24W	1330 LM	3000°K	● ROSE CLAIR	€ 196,00
ID/02786410	24W	1330 LM	3000°K	● BLEU CLAIR	€ 196,00
ID/02786411	24W	1330 LM	3000°K	● BLEU PETROLE	€ 196,00



SUSPENSIONS

BASE RONDE

IP20 ↑ 230V

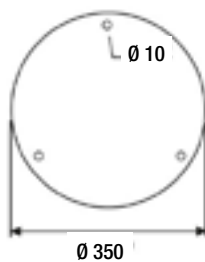

Le conseil de l'éclairagiste:

Vous souhaitez créer une composition de plusieurs petites suspensions mais en utilisant une seule arrivée électrique ? Utilisez une patère qui peut regrouper plusieurs luminaires fonctionnant en 230v, vous obtiendrez un résultat original avec une finition impeccable.

NEW

RÉF. ID	COULEUR	NOMBRE DE SUSPENSIONS	DIMENSIONS MM	MATÉRIAU	PRIX HTVA
ID/03468845	○ BLANC MAT	3	Ø 350 X 25	ACIER	€ 26,00
ID/03224838	● NOIR MAT	3	Ø 350 X 25	ACIER	€ 26,00



BASE LINEAIRE



230V



900

- Suspensions non comprises

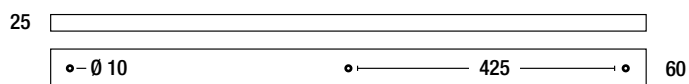

1200

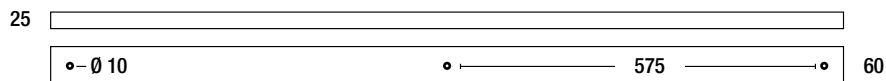

1500

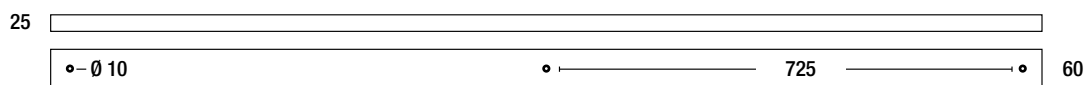

1800

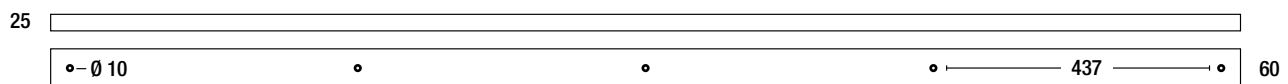

NEW

RÉF. ID	COULEUR	NOMBRE DE SUSPENSIONS	DIMENSIONS MM	MATÉRIAU	PRIX HTVA
ID/03468849	○ BLANC	3	25 X 900 X 60	ACIER	€ 35,00
ID/03224839	● NOIR	3	25 X 900 X 60	ACIER	€ 35,00
ID/03468850	○ BLANC	3	25 X 1 200 X 60	ACIER	€ 44,00
ID/03468846	● NOIR	3	25 X 1 200 X 60	ACIER	€ 44,00
ID/03468851	○ BLANC	3	25 X 1 500 X 60	ACIER	€ 58,00
ID/03468847	● NOIR	3	25 X 1 500 X 60	ACIER	€ 58,00
ID/03468852	○ BLANC	5	25 X 1 800 X 60	ACIER	€ 66,00
ID/03468848	● NOIR	5	25 X 1 800 X 60	ACIER	€ 66,00



SUSPENSIONS

TOKYO

LED 3 ANS IP20 120° IRC 80 TRIAC ↑ A++ A 230V

SUSPENSIONS



NEW

RÉF. ID	PUISSANCE	FLUX	T°	COULEUR	MATÉRIAU	PRIX HTVA
ID/03383236	38W	2280 LM	3000°K	○ BLANC	ALUMINIUM	€ 259,00
ID/03383237	38W	2280 LM	3000°K	● NOIR	ALUMINIUM	€ 259,00
ID/03383238	60W	3600 LM	3000°K	○ BLANC	ALUMINIUM	€ 495,00
ID/03383239	60W	3600 LM	3000°K	● NOIR	ALUMINIUM	€ 495,00

TALOWE

LED 3 ANS IP20 IRC 80 TRIAC ↑ A++ A 230V



Suspension circulaire avec un seul point de fixation pour faciliter le placement.



RÉF. ID	PUISSANCE	FLUX	T°	COULEUR	MATÉRIAU	PRIX HTVA
ID/02325583	39W	2340 LM	3000°K	○ BLANC	ALUMINIUM	€ 248,00
ID/02773238	39W	2340 LM	3000°K	● NOIR	ALUMINIUM	€ 295,00

Disponible en plafonnier page 113

SUSPENSIONS

BOA

LED IP20 IRC 80 TRIAC ↑ A++ A 230V

SUSPENSIONS

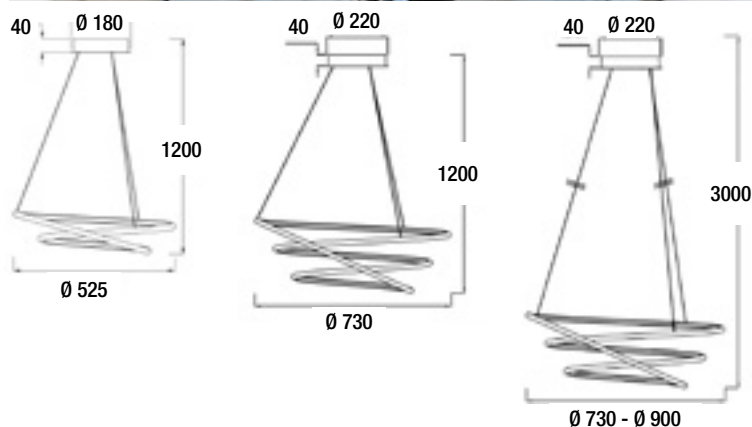

NEW

RÉF. ID	PUISSANCE	FLUX	T°	COULEUR	DIMENSIONS MM	MATÉRIAU	PRIX HTVA
ID/02878681	47W	3055 LM	3000°K	○ BLANC	Ø 525 X 1200	ALUMINIUM	€ 240,00
ID/02878678	47W	1645 LM	3000°K	● NOIR	Ø 525 X 1200	ALUMINIUM	€ 240,00
ID/02878682	88W	5720 LM	3000°K	○ BLANC	Ø 730 X 1200	ALUMINIUM	€ 440,00
ID/02878679	88W	3080 LM	3000°K	● NOIR	Ø 730 X 1200	ALUMINIUM	€ 440,00
ID/03224856	88W	5720 LM	3000°K	○ BLANC	Ø 730 X 3000	ALUMINIUM	€ 450,00
ID/03224854	88W	3080 LM	3000°K	● NOIR	Ø 730 X 3000	ALUMINIUM	€ 450,00
ID/03224857	105W	6825 LM	3000°K	○ BLANC	Ø 900 X 3000	ALUMINIUM	€ 625,00
ID/03224855	105W	3675 LM	3000°K	● NOIR	Ø 900 X 3000	ALUMINIUM	€ 625,00

TRINITI

LED IP20 IRC 80 TRIAC ↑ A++ A 230V

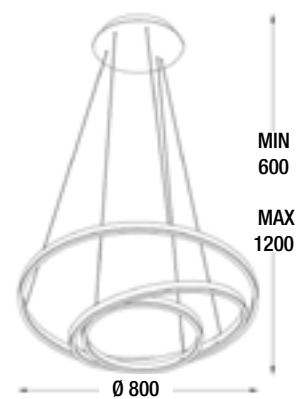

SUSPENSIONS



RÉF. ID	PUISSANCE	FLUX	T°	COULEUR	DIMENSIONS MM	PRIX HTVA
ID/02773239	136W	8160 LM	3000°K	● NOIR	Ø 800 X 1200	€ 578,00

SUSPENSIONS

GURI

LED IP20 IRC 80 TRIAC ↑ A++ 230V



SUSPENSIONS

NEW

RÉF. ID	PUISSANCE	FLUX	T°	COULEUR	DIAMETRE MM	MATÉRIAU	PRIX HTVA
ID/03468878	54W	1890 LM	3000°K	● NOIR	Ø 600	ALUMINIUM/PLEXI	€ 290,00
ID/03468879	76W	2660 LM	3000°K	● NOIR	Ø 900	ALUMINIUM/PLEXI	€ 480,00
ID/03468880	125W	4125 LM	3000°K	● NOIR	Ø 1200	ALUMINIUM/PLEXI	€ 580,00

ENIMA SUSPENSION

LED 5 ANS IP40 IRC ≥90 TRIAC ↑ A+

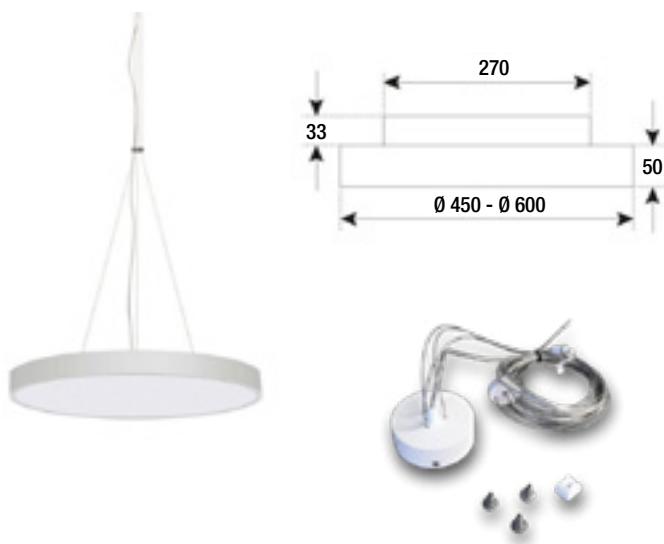

RÉF. ID	PUISSANCE	FLUX	T°	COULEUR	DIAMETRE MM	MATÉRIAU	PRIX HTVA
ID/02558616	24W + 7W	2400 LM	3000°K	○ BLANC	Ø 450	ALUMINIUM	€ 325,00
ID/02558617	33W + 6W	3200 LM	3000°K	○ BLANC	Ø 600	ALUMINIUM	€ 445,00
ID/02558618	KIT DE SUSPENSION 2M + ROSACE BLANC (REQUIS)						€ 50,00

PURE LINE

LED IP20 IRC >80 TRIAC ↑ A++ A 230V

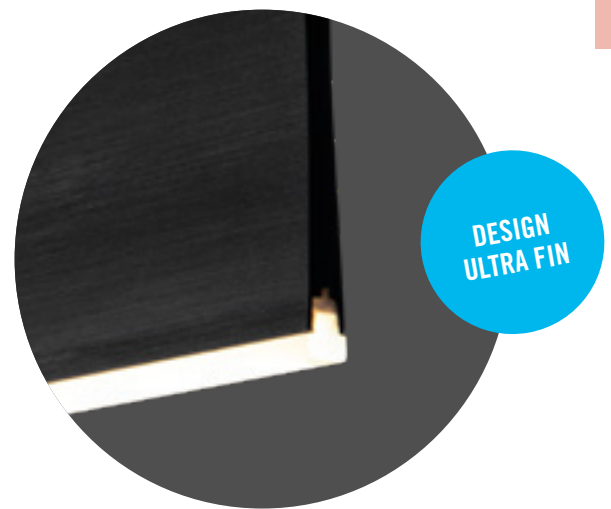
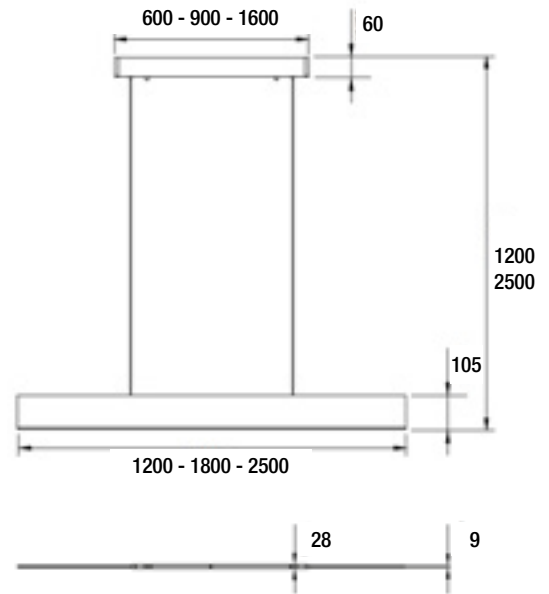

SUSPENSIONS

RÉF. ID	PUISSANCE	FLUX	T°	COULEUR	DIMENSIONS MM	MATÉRIAU	PRIX HTVA
ID/02877799	26W	1820 LM	3000°K	○ BLANC	9 X 1200 X 1200	ALUMINIUM	€ 280,00
ID/02877804	26W	1820 LM	3000°K	● NOIR	9 X 1200 X 1200	ALUMINIUM	€ 280,00
ID/02877795	26W	1820 LM	3000°K	● BRONZE	9 X 1200 X 1200	ALUMINIUM	€ 280,00
ID/02877800	37W	2590 LM	3000°K	○ BLANC	9 X 1800 X 1200	ALUMINIUM	€ 475,00
ID/02877805	37W	2590 LM	3000°K	● NOIR	9 X 1800 X 1200	ALUMINIUM	€ 475,00
ID/02879044	42W	2940 LM	3000°K	○ BLANC	9 X 2500 X 1200	ALUMINIUM	€ 1 290,00
ID/02879048	42W	2940 LM	3000°K	● NOIR	9 X 2500 X 1200	ALUMINIUM	€ 1 290,00

SIGMA

LED 5 ANS IP20 IRC ≥90 TRIAC ↑ A+ 230V



SUSPENSIONS



RÉF. ID	PUISSANCE	FLUX	T°	COULEUR	DIMENSIONS MM	PRIX HTVA
ID/02772930	30W	2764 LM	2700°K	○ BLANC	35 X 20 X 1185	€ 175,00
ID/02772929	30W	2764 LM	2700°K	● ALU	35 X 20 X 1185	€ 205,00
ID/02773200	30W	2764 LM	2700°K	● NOIR	35 X 20 X 1185	€ 175,00
ID/02772932	34W	3132 LM	2700°K	○ BLANC	35 X 20 X 1475	€ 227,00
ID/02772931	34W	3132 LM	2700°K	● ALU	35 X 20 X 1475	€ 245,00
ID/02773201	34W	3132 LM	2700°K	● NOIR	35 X 20 X 1475	€ 227,00

RAYA

LED 5 ANS IP20 IRC 80 TRIAC ↑ A++ A 230V

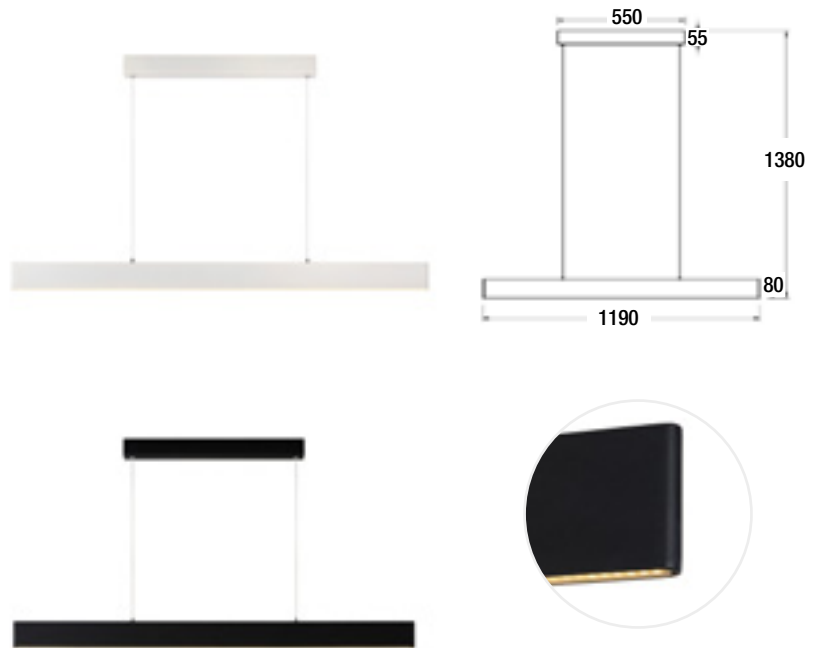

NEW

RÉF. ID	PUISSANCE	FLUX	T°	COULEUR	PRIX HTVA
ID/02509853	36W	3420 LM	2700°K	○ BLANC	€ 207,00
ID/02509852	36W	3420 LM	2700°K	● NOIR	€ 207,00

SYTZE

LED 5 ANS IP20 IRC 80 TRIAC ↑ A++ A 230V

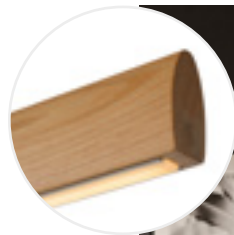
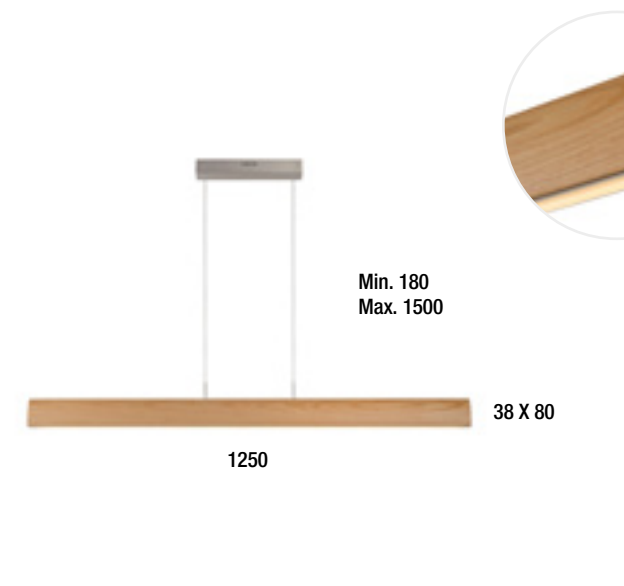

RÉF. ID	PUISSANCE	FLUX	T°	COULEUR	PRIX HTVA
ID/02612138	32W	2560 LM	3000°K	● BOIS NATUREL	€ 273,00

SUSPENSIONS

SUSPENSIONS

IZAK

LED 5 ANS IP20 IRC ≥90 TRIAC ↑ A++ A 230V

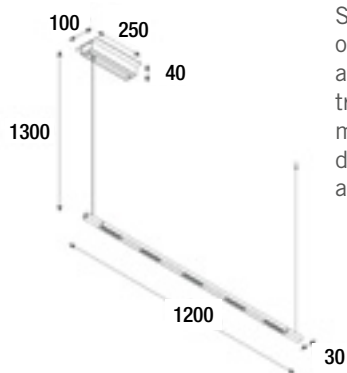
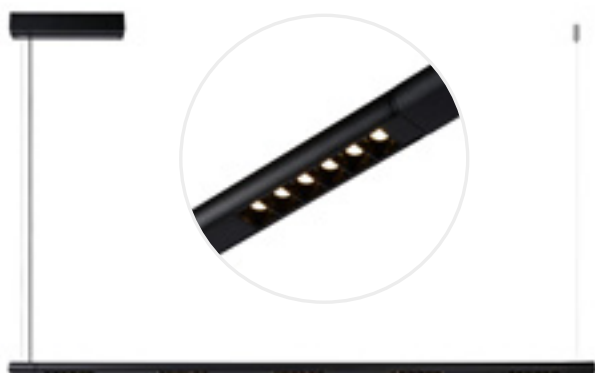

Sobre, design et fonctionnelle, Izak offre un éclairage uniforme, idéal autant au-dessus d'une surface de travail que d'une table de salle à manger. Izak est également équipée d'un capteur de mouvement pour un allumage on/off de la main.

SUSPENSIONS



NEW

RÉF. ID	PUISSANCE	FLUX	T°	COULEUR	MATÉRIAU	PRIX HTVA
ID/03382624	4 X 30W	4 X 3660 LM	2700°K	● NOIR	ALUMINIUM	€ 256,00

DARF 1

LED IP20 IRC 80        230V 

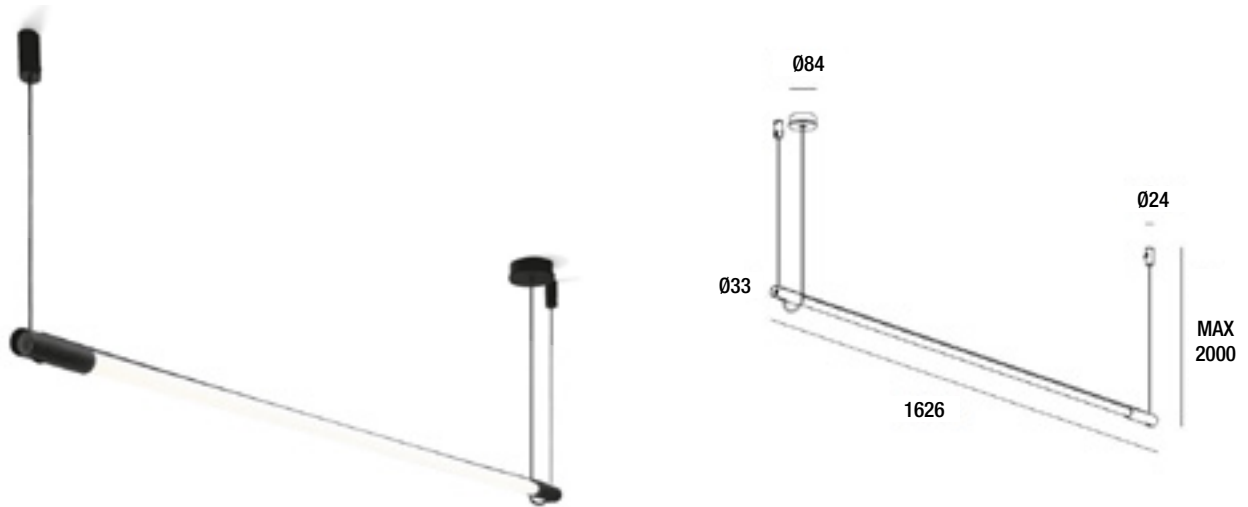

Le conseil de l'éclairagiste:

Il est fréquent qu'une arrivée électrique ne soit pas centrée par rapport à la partie d'espace (plan de travail, table...) à éclairer. Lorsque ce décalage ne dépasse pas 1m, une suspension avec un câble d'alimentation indépendant de ses câbles de suspension représente, dans bien des cas, une solution très pratique et non moins esthétique.

NEW

RÉF. ID	PUISSANCE	FLUX	T°	COULEUR	MATÉRIAU	PRIX HTVA
ID/03361314	25W	3300 LM	3000°K	● NOIR	ALUMINIUM	€ 207,00
ID/03361315	25W	3700 LM	4000°K	● NOIR	ALUMINIUM	€ 207,00

Disponible en applique page 212



SUSPENSIONS

RODA P

LED 5 ANS IP20 IRC >80 0-10V ↑ A++ 230V

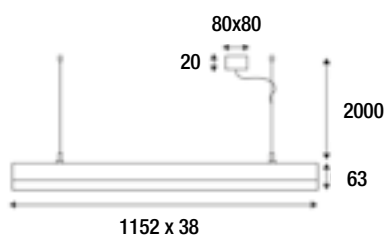

- Diffuseur en polycarbonate
- Livrée avec câbles de suspension en acier (réglable 2.00m max), base carrée et câble d'alimentation blanc ou noir
- Convertisseur dimmable inclus dans le profil

SUSPENSIONS

RÉF. ID	PUISSANCE	FLUX	T°	COULEUR	MATÉRIAU	PRIX HTVA
ID/03126141	18W	1900 LM	3000°K	○ BLANC	ALUMINIUM	€ 210,00
ID/03126140	18W	1900 LM	3000°K	● NOIR	ALUMINIUM	€ 210,00
ID/03126139	18W	2000 LM	4000°K	○ BLANC	ALUMINIUM	€ 210,00
ID/03126138	18W	2000 LM	4000°K	● NOIR	ALUMINIUM	€ 210,00

Disponible en plafonnier page 118

SULLY P

LED 5 ANS IP20 IRC 80 DALI ↑ A++ 230V

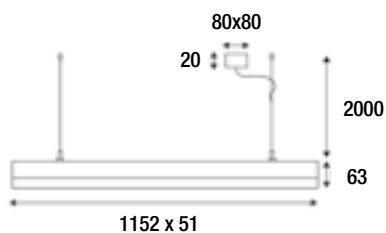

- Diffuseur en polycarbonate
- Livrée avec câbles de suspension en acier (réglable 2.00m max), base carrée et câble d'alimentation blanc ou noir
- Convertisseur dimmable DALI inclus dans le profil

RÉF. ID	PUISSANCE	FLUX	T°	COULEUR	MATÉRIAU	PRIX HTVA
ID/03126145	26W	2850 LM	3000°K	○ BLANC	ALUMINIUM	€ 350,00
ID/03126144	26W	2850 LM	3000°K	● NOIR	ALUMINIUM	€ 350,00
ID/03126143	26W	3000 LM	4000°K	○ BLANC	ALUMINIUM	€ 350,00
ID/03126142	26W	3000 LM	4000°K	● NOIR	ALUMINIUM	€ 350,00

Disponible en plafonnier page 118

OZORA

LED 5 ANS IP20 33° IRC >80 0-10V ↑ A++

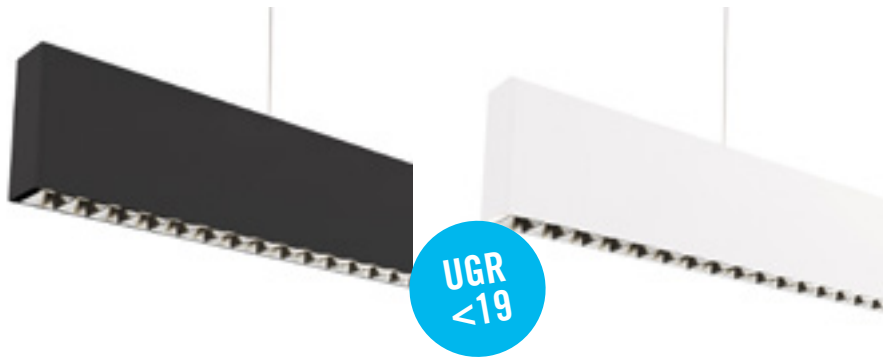

- Réflecteur basse luminance

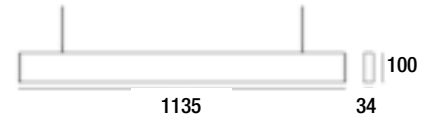

RÉF. ID	PUISSANCE	FLUX	T°	UGR	COULEUR	MATÉRIAU	PRIX HTVA
ID/03174687	30W	3480 LM	3000°K	< 19	○ BLANC	ALUMINIUM	€ 314,00
ID/03174686	30W	3480 LM	3000°K	< 19	● NOIR	ALUMINIUM	€ 314,00

SUSPENSIONS

PROLINE ROW 1

LED 5 ANS IP20 50° IRC 80 1-10V ↑ A++



- Sans scintillement

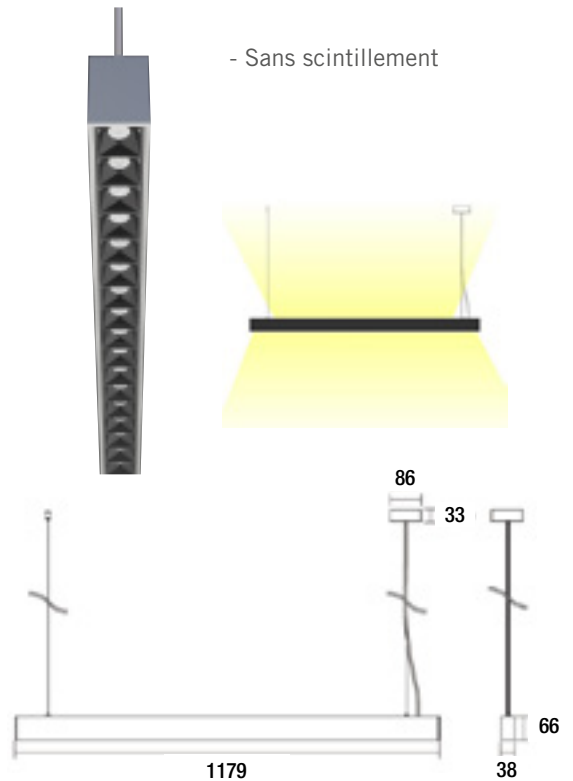

RÉF. ID	PUISSANCE	FLUX	T°	UGR	COULEUR	MATÉRIAU	PRIX HTVA
ID/02752539	2 X 25W	2 X 3250 LM	3000°K	<6	○ BLANC	ALUMINIUM	€ 335,00
ID/02752543	2 X 25W	2 X 3250 LM	3000°K	<6	● NOIR	ALUMINIUM	€ 335,00

SUSPENSIONS

TRIMLESS

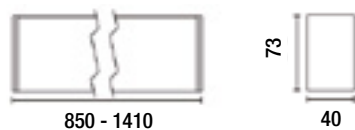

- Kit de suspension en option
- Possibilité 4000°K sur demande
- Possibilité dimmable DALI sur demande
- Connexion aisée de plusieurs plafonniers/ suspensions trimless en ligne sans besoin d'accessoires optionnels



SUSPENSIONS

RÉF. ID	PUISSANCE	FLUX	T°	COULEUR	LONGUEUR MM	MATÉRIAU	PRIX HTVA
ID/02262260	19W	2500 LM	3000°K	○ BLANC	850	ALUMINIUM	€ 210,00
ID/02262261	19W	2500 LM	3000°K	● NOIR	850	ALUMINIUM	€ 210,00
ID/02262262	19W	2500 LM	3000°K	● GRIS	850	ALUMINIUM	€ 210,00
ID/02262254	35W	4850 LM	3000°K	○ BLANC	850	ALUMINIUM	€ 210,00
ID/02262255	35W	4850 LM	3000°K	● NOIR	850	ALUMINIUM	€ 210,00
ID/02262256	35W	4850 LM	3000°K	● GRIS	850	ALUMINIUM	€ 210,00
ID/02262272	25W	3400 LM	3000°K	○ BLANC	1130	ALUMINIUM	€ 215,00
ID/02262273	25W	3400 LM	3000°K	● NOIR	1130	ALUMINIUM	€ 215,00
ID/02262274	25W	3400 LM	3000°K	● GRIS	1130	ALUMINIUM	€ 215,00
ID/02262266	46W	6500 LM	3000°K	○ BLANC	1130	ALUMINIUM	€ 235,00
ID/02262267	46W	6500 LM	3000°K	● NOIR	1130	ALUMINIUM	€ 235,00
ID/02262268	46W	6500 LM	3000°K	● GRIS	1130	ALUMINIUM	€ 235,00
ID/02262284	31W	4300 LM	3000°K	○ BLANC	1410	ALUMINIUM	€ 225,00
ID/02262285	31W	4300 LM	3000°K	● NOIR	1410	ALUMINIUM	€ 245,00
ID/02262286	31W	4300 LM	3000°K	● GRIS	1410	ALUMINIUM	€ 245,00
ID/02262278	57W	8100 LM	3000°K	○ BLANC	1410	ALUMINIUM	€ 265,00
ID/02262279	57W	8100 LM	3000°K	● NOIR	1410	ALUMINIUM	€ 265,00
ID/02262280	57W	8100 LM	3000°K	● GRIS	1410	ALUMINIUM	€ 265,00
RÉF. ID							PRIX HTVA

ID/00817696



KIT 2 X CABLES DE SUSPENSION 2M + CABLE TRANSPARENT 2M 3 X 0,75MM²
+ CABLE BASE 54 X 54 X 35

€ 25,00

Disponible en plafonnier page 116

LEDLINER 35

LED IP20 IRC ≥90 0-10V ↑ A++ A 230V

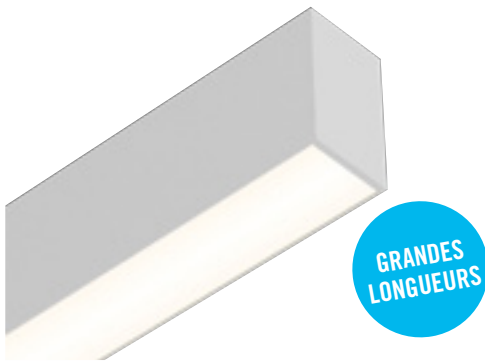

GRANDES LONGUEURS



- Diffuseur en polycarbonate
- Convertisseur intégré dans le profil
- Possibilité 4000°K sur demande
- Possibilité dimmable DALI sur demande
- Possibilité de longueurs sur mesure sur demande

RÉF. ID	PUISSANCE	FLUX	T°	COULEUR	LONGUEUR MM	MATÉRIAU	PRIX HTVA
ID/02769324	40.3W	6786 LM	3000°K	○ BLANC	1863	ALUMINIUM	€ 531,00
ID/03004737	40.3W	6786 LM	3000°K	● NOIR	1863	ALUMINIUM	€ 531,00
ID/02769328	52.7W	8874 LM	3000°K	○ BLANC	2424	ALUMINIUM	€ 630,00
ID/03004745	52.7W	8874 LM	3000°K	● NOIR	2424	ALUMINIUM	€ 630,00
ID/02769332	65.1W	10962 LM	3000°K	○ BLANC	2986	ALUMINIUM	€ 827,00
ID/03004753	65.1W	10962 LM	3000°K	● NOIR	2986	ALUMINIUM	€ 827,00

Disponible en plafonnier page 119



SUSPENSIONS

INDIVILED

LED 5 ANS IP20 70° IRC 80 230V

- Possibilité dimmable DALI sur demande



UGR <16

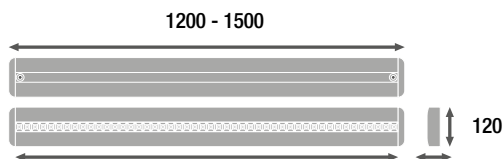





NEW

SUSPENSIONS

RÉF. ID	PUISSANCE	FLUX	T°	COULEUR	LONGUEUR MM	FAISCEAU	AVEC SENSOR	PRIX HTVA
ID/02866132	34W	3800 LM	3000°K	○ BLANC	1200	DOWNLIGHT	NON	€ 210,00
ID/02866133	34W	4200 LM	4000°K	○ BLANC	1200	DOWNLIGHT	NON	€ 210,00
ID/02866162	34W	3800 LM	3000°K	○ BLANC	1200	DOWNLIGHT	OUI	€ 262,00
ID/02866163	34W	4200 LM	4000°K	○ BLANC	1200	DOWNLIGHT	OUI	€ 262,00
ID/02866138	42W	4650 LM	3000°K	○ BLANC	1200	UP/DOWNLIGHT	NON	€ 280,00
ID/02866139	42W	5050 LM	4000°K	○ BLANC	1200	UP/DOWNLIGHT	NON	€ 280,00
ID/02866168	42W	4650 LM	3000°K	○ BLANC	1200	UP/DOWNLIGHT	OUI	€ 332,00
ID/02866169	42W	5050 LM	4000°K	○ BLANC	1200	UP/DOWNLIGHT	OUI	€ 332,00
ID/02866134	25W	3100 LM	3000°K	○ BLANC	1500	DOWNLIGHT	NON	€ 210,00
ID/02866135	25W	3300 LM	4000°K	○ BLANC	1500	DOWNLIGHT	NON	€ 210,00
ID/02866164	25W	3100 LM	3000°K	○ BLANC	1500	DOWNLIGHT	OUI	€ 262,00
ID/02866165	25W	3300 LM	4000°K	○ BLANC	1500	DOWNLIGHT	OUI	€ 262,00
ID/02866136	48W	5300 LM	3000°K	○ BLANC	1500	DOWNLIGHT	NON	€ 280,00
ID/02866137	48W	5700 LM	4000°K	○ BLANC	1500	DOWNLIGHT	NON	€ 280,00
ID/02866166	48W	5300 LM	3000°K	○ BLANC	1500	DOWNLIGHT	OUI	€ 332,00
ID/02866167	48W	5700 LM	4000°K	○ BLANC	1500	DOWNLIGHT	OUI	€ 332,00
ID/02866140	56W	6150 LM	3000°K	○ BLANC	1500	UP/DOWNLIGHT	NON	€ 350,00
ID/02866141	56W	6550 LM	4000°K	○ BLANC	1500	UP/DOWNLIGHT	NON	€ 350,00
ID/02866170	56W	6150 LM	3000°K	○ BLANC	1500	UP/DOWNLIGHT	OUI	€ 400,00
ID/02866171	56W	6550 LM	4000°K	○ BLANC	1500	UP/DOWNLIGHT	OUI	€ 400,00

ACCESSOIRES INDIVILED

NEW RÉF. ID	ACCESSOIRES EN OPTION	PRIX HTVA
ID/02866449	 KIT CABLAGE TRAVERSANT INDIVILED 1200	€ 32,00
ID/02866445	 KIT CABLAGE TRAVERSANT INDIVILED 1500	€ 35,00
ID/02866444	 FIXATION POUR INSTALLATION EN LIGNE CONTINUE	€ 18,00
ID/02866441	 KIT SUSPENSION (ALIM 1,5M 3X0,75MM ² + 2 CABLES SUSP. Y 1,5M)	€ 88,00
ID/02866443	 CÂBLE SUSPENSION Y 1,5M)	€ 18,00







































APPLIQUES MURALES

PAGES 194 À 225











Liseuse, éclairage tableau, à diffusion directe, indirecte... les appliques murales sont aussi diverses que les lieux où elles peuvent remplir une fonction d'éclairage classique ou plus spécifique comme dans le cas d'une liseuse par exemple. Associées à un variateur, la plupart d'entre elles permettent une modulation agréable et très pratique des ambiances intérieures.



APPLIQUES MURALES

								
SHEFFIELD 196	CHAMONIX 197	MILO 198	MILO 2 198	GALEN 198	CROBAT 199	MIZUKO 199	BOXER 200	LOPAL 200
								
ATKIN 201	SEBO 202	TANNER 203	FIX WALL 203	NEW TURNON 204	NEW OREGON 204	NEW SARA SNOOZE 205	ARTHUR 206	THOR 207
								
MYRA 207	EKLYPS LED 208	OVALIS 209	GLAM 209	NEW ODREY WALL 210	NEW DARF 1 212	MALTA 212	MALTA 2 213	STEP 213
								
KUPA 214	KAVA 214	CUSCO 215	FULLA 215	HEDI 216	LONGA 217	THIN 217	BOX MINI 2.0 218	RAY MINI 2.0 219

APPLIQUES SALLE DE BAINS

								
VIEW 220	VIEW 900 221	NEW AMUR 221	BETHAN 222	NEW EVIA 222	JEDI 223	MIRO 223	NEW MIRBA 1 224	NEW MIRBA 2 225
								
NEW MIRBA 3 225								

APPLIQUES MURALES

SHEFFIELD

LED 3 ANS IP20 IRC >80 A++ 230V



APPLIQUES MURALES

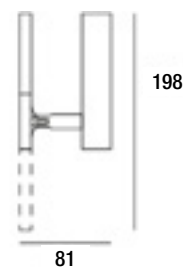
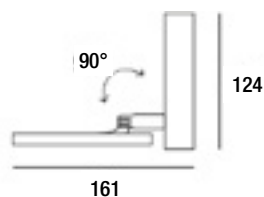
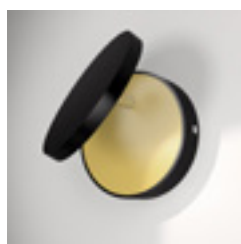
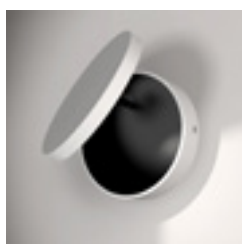
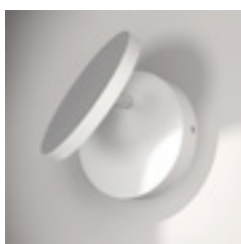

RÉF. ID	PUISSANCE	FLUX	T°	COULEUR	PRIX HTVA
ID/01448933	7 W	680 LM	3000°K	○ BLANC	€ 145,00
ID/01448934	7 W	680 LM	3000°K	◐ BLANC / NOIR	€ 145,00
ID/01448935	7 W	680 LM	3000°K	◑ NOIR / OR	€ 145,00

APPLIQUES MURALES

CHAMONIX

LED 3 ANS IP20 SWITCH O I IRC >80 A++ 230V



APPLIQUES MURALES

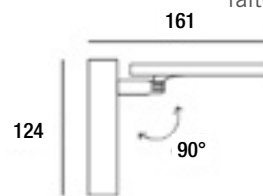
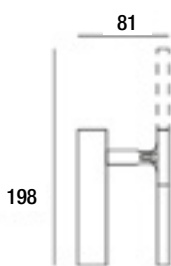

A l'aide de l'interrupteur, passez du mode applique au mode liseuse et faites varier l'intensité

RÉF. ID	PUISSANCE	FLUX	T°	COULEUR	PRIX HTVA
ID/02679188	7 W + 2,7W DIM	680 LM	3000°K	○ BLANC	€ 199,00
ID/02679189	7 W + 2,7W DIM	680 LM	3000°K	● NOIR	€ 199,00

APPLIQUES MURALES

MILO

LED 3 ANS IP20 SWITCH O I 90° 40° IRC >90 A++ A 230V

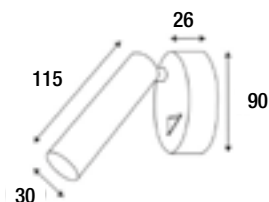

RÉF. ID	PUISSANCE	FLUX	T°	COULEUR	PRIX HTVA
ID/02510137	5W	320 LM	3000°K	○ BLANC MAT	€ 109,00
ID/02510136	5W	320 LM	3000°K	● NOIR MAT	€ 109,00
ID/02510138	5W	320 LM	3000°K	● LAITON BROSSE	€ 115,00

MILO 2

LED 3 ANS IP20 SWITCH O I 90° 40° IRC >90 A++ A 230V



2 PORTS USB

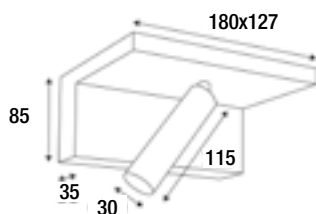

- Trois niveaux d'éclairage (25%, 50% et 100%)
- Deux prises USB (5VDC, 2A)

RÉF. ID	PUISSANCE	FLUX	T°	COULEUR	PRIX HTVA
ID/02682258	5W	330 LM	3000°K	○ BLANC MAT	€ 140,00
ID/02682257	5W	330 LM	3000°K	● NOIR MAT	€ 140,00

GALEN

LED 5 ANS IP20 SWITCH O I 90° A++ A 230V

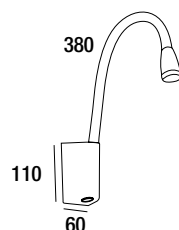

BRAS FLEXIBLE

RÉF. ID	PUISSANCE	FLUX	T°	COULEUR	PRIX HTVA
ID/02539720	3W	260 LM	3000°K	○ BLANC	€ 78,00
ID/02539719	3W	260 LM	3000°K	● NOIR	€ 78,00

APPLIQUES MURALES

CROBAT

LED 5 ANS IP20 SWITCH O I IRC 80 230V

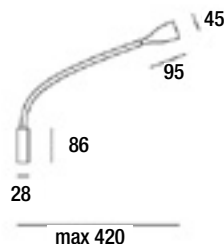

BRAS FLEXIBLE

RÉF. ID	PUISSANCE	FLUX	T°	COULEUR	PRIX HTVA
ID/02612579	3,8W	311 LM	3000°K	○ BLANC	€ 39,00
ID/02612580	3,8W	311 LM	3000°K	● NOIR	€ 39,00

MIZUKO

IP20 SWITCH O I TRIAC 230V



- Bras articulé au 1er tiers sur l'axe horizontal
- Tête articulée pour rotation gauche/droite

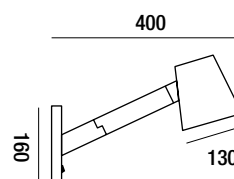

RÉF. ID	CULOT	PUISSANCE MAX	FLUX MAX	COULEUR	PRIX HTVA
ID/02509817	E14	6W	600 LM	● NOIR	€ 104,00



APPLIQUES MURALES

BOXER

LED 3 ANS IP20 SWITCH O I ← A++ A 230V

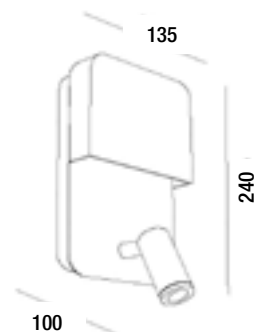
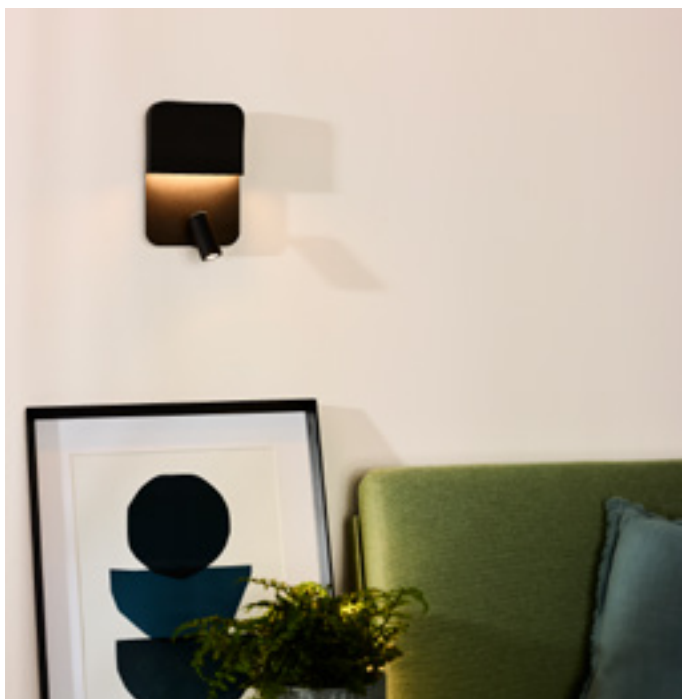

APPLIQUES MURALES

RÉF. ID	PUISSANCE	FLUX	T°	COULEUR	PRIX HTVA
ID/02773006	5W + 3W	375 LM + 225 LM	3000°K	○ BLANC MAT	€ 79,00
ID/02773005	5W + 3W	375 LM + 225 LM	3000°K	● NOIR MAT	€ 79,00

LOPAL

LED IP20 SWITCH O I IRC >90 ← A++ A 230V



BRAS FLEXIBLE

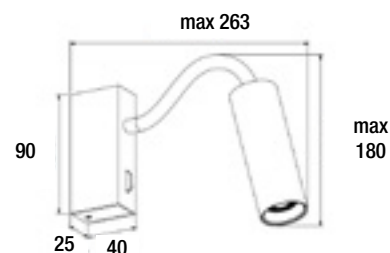

RÉF. ID	PUISSANCE	FLUX	T°	COULEUR	PRIX HTVA
ID/02879157	4W	360 LM	2700°K	○ BLANC MAT	€ 58,00
ID/02879163	4W	360 LM	2700°K	● NOIR MAT	€ 58,00

APPLIQUES MURALES

ATKIN

LED 3 ANS IP20 SWITCH O I A++ 230V

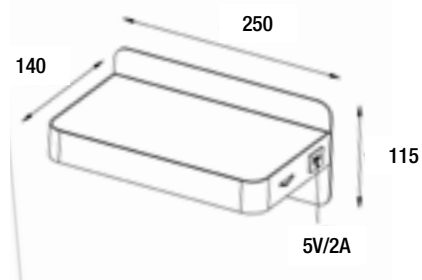

RÉF. ID	PUISSANCE	FLUX	T°	COULEUR	PRIX HTVA
ID/02612177	5W	350 LM	2700°K	○ BLANC	€ 83,00
ID/02612176	5W	350 LM	2700°K	● NOIR	€ 83,00

APPLIQUES MURALES



APPLIQUES MURALES

SEBO



PIED DE
LAMPE
MAGNÉTIQUE

AVEC FICHE

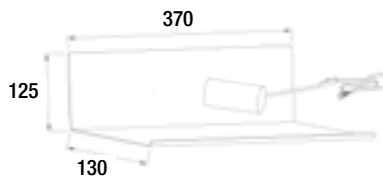

RÉF. ID	CULOT	PUISSANCE MAX	FLUX MAX	COULEUR	PRIX HTVA
ID/02611980	E27	MAX 9W	800 LM	○ BLANC	€ 39,00
ID/02611979	E27	MAX 9W	800 LM	● NOIR	€ 39,00

APPLIQUES MURALES



APPLIQUES MURALES

TANNER

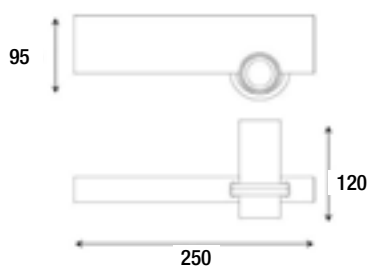

NEW

RÉF. ID	CULOT	PUISSANCE MAX	FLUX MAX	COULEUR	MATÉRIAU	PRIX HTVA
ID/03382657	E27	MAX 9W	800 LM	● NOIR/GRIS	ALUMINIUM/BETON	€ 46,00
ID/03382658	E27	MAX 9W	800 LM	● NOIR/BOIS	ALUMINIUM/BOIS	€ 39,00

Disponible en suspension page 164
Disponible en lampe à poser page 229

FIX WALL

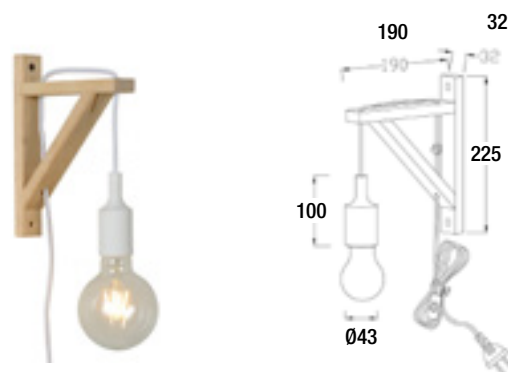

RÉF. ID	CULOT	PUISSANCE MAX	FLUX MAX	COULEUR	PRIX HTVA
ID/02611981	E27	MAX 9W	800 LM	○ BLANC	€ 16,50
ID/02604376	E27	MAX 9W	800 LM	● NOIR	€ 16,50

APPLIQUES MURALES

TURNON

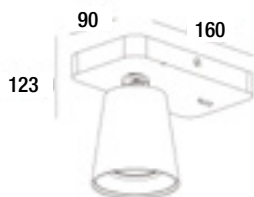

Avec son intérieur d'abat-jour en laiton qui contraste avec la finition noire de l'ensemble, Turnon est un modèle d'élégance. Munie d'un interrupteur on/off, Turnon est livrée avec une lampe Dim-to-warm qui peut être connectée à un variateur.

NEW

RÉF. ID	CULOT	PUISSANCE	FLUX	T°	COULEUR	MATÉRIAU	PRIX HTVA
ID/03274724	GU10	5W	320 LM	2200 - 3000°K	● NOIR/LAITON	ALUMINIUM	€ 36,00

OREGON

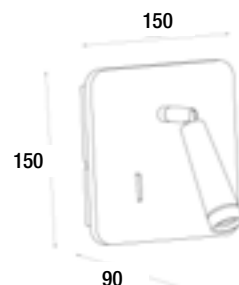
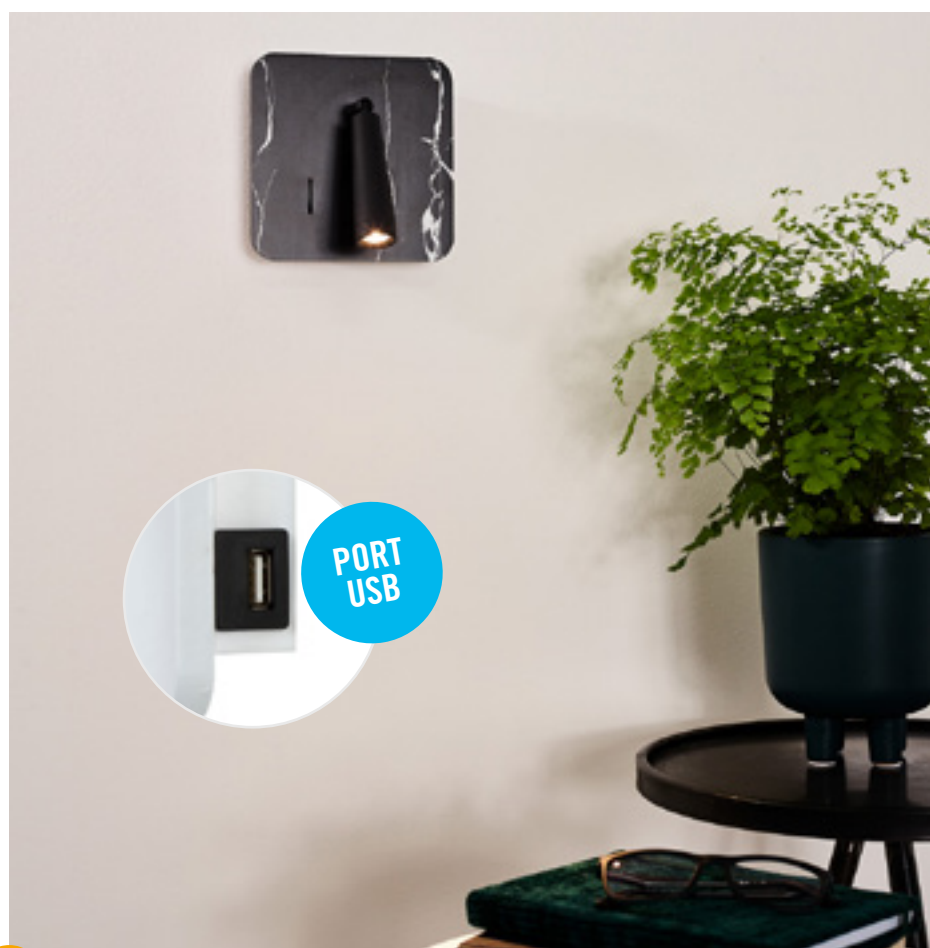

NEW

RÉF. ID	PUISSANCE	FLUX	T°	COULEUR	MATÉRIAU	PRIX HTVA
ID/03170199	3W	240 LM	3000°K	● NOIR	METAL	€ 49,00
ID/03170200	3W	240 LM	3000°K	○ BLANC	METAL	€ 49,00

APPLIQUES MURALES

SARA SNOOZE



Spot orientable disponible en plusieurs coloris, Sara Snooze possède un interrupteur on/off et est orientable pour placer la lumière là où vous le souhaitez.

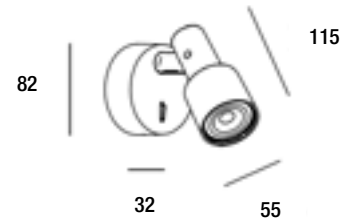

NEW

RÉF. ID	CULOT	PUISSANCE MAX	FLUX MAX	COULEUR	MATÉRIAU	PRIX HTVA
ID/03362134	GU10	MAX 9W	575 LM	○ BLANC	ALUMINIUM	€ 133,00
ID/03362131	GU10	MAX 9W	575 LM	● NOIR	ALUMINIUM	€ 133,00
ID/03362132	GU10	MAX 9W	575 LM	● DORE	ALUMINIUM	€ 140,00
ID/03362133	GU10	MAX 9W	575 LM	● NOIR/DORE	ALUMINIUM	€ 141,00

APPLIQUES MURALES



APPLIQUES MURALES

ARTHUR



230V

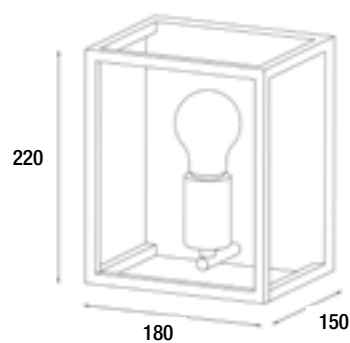

RÉF. ID	CULOT	PUISSANCE MAX	FLUX MAX	COULEUR	MATÉRIAU	PRIX HTVA
ID/02773194	E27	MAX 9W	800 LM	● NOIR	MÉTAL	€ 35,00

Disponible en plafonnier page 120
Disponible en suspension page 165
Disponible en lampe à poser page 230

APPLIQUES MURALES

THOR

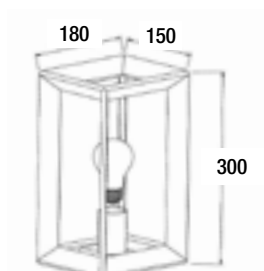

RÉF. ID	CULOT	PUISSANCE MAX	FLUX MAX	COULEUR	MATÉRIAU	PRIX HTVA
ID/02612161	E27	MAX 9W	800 LM	● FER GRIS	MÉTAL	€ 97,00

Disponible en plafonnier page 121
 Disponible en suspension page 166
 Disponible en lampe à poser page 231

MYRA

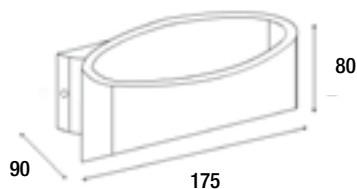
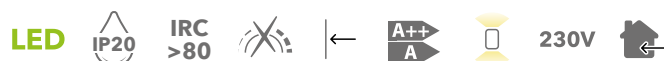

Le conseil de l'éclairagiste:

La finition intérieure d'un abat-jour ou d'un diffuseur influence sur la chaleur de la lumière qui s'en échappe. Ainsi une finition dorée apportera à l'éclairage du luminaire une touche plus chaude qu'une finition blanche.

RÉF. ID	PUISSANCE	FLUX	T°	COULEUR	PRIX HTVA
ID/02878402	5W	410 LM	3000°K	○ BLANC MAT	€ 130,00
ID/02878404	5W	410 LM	3000°K	● NOIR MAT/OR	€ 130,00

APPLIQUES MURALES

EKLYPS LED

LED 3 ANS IP20 IRC >80



A++

230V

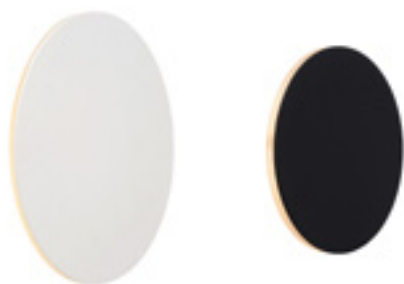

Le conseil de l'éclairagiste:

Les appliques à diffusion lumineuse indirecte sont idéales dans une pièce comme un salon ou une chambre. Elles créent une ambiance lumineuse douce et sans aucun éblouissement pour l'œil. Ajoutez-leur un variateur pour encore en augmenter leurs qualités d'utilisation.

APPLIQUES MURALES

RÉF. ID	PUISSANCE	FLUX	T°	COULEUR	DIMENSIONS MM	PRIX HTVA
ID/02325581	6W	360 LM	3000°K	○ BLANC MAT	Ø 150 X 30	€ 66,00
ID/02773236	6W	360 LM	3000°K	● NOIR	Ø 150 X 30	€ 76,00
ID/02325582	8W	480 LM	3000°K	○ BLANC MAT	Ø 250 X 30	€ 83,00
ID/02773237	8W	480 LM	3000°K	● NOIR	Ø 250 X 30	€ 95,00



APPLIQUES MURALES

OVALIS

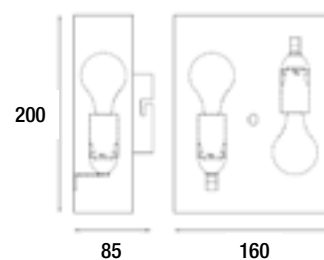

APPLIQUES MURALES

RÉF. ID	CULOT	PUISSANCE MAX	FLUX MAX	COULEUR	PRIX HTVA
ID/02085358	2 X E14	MAX 2 X 9W	2 X 800 LM	○ BLANC	€ 40,00
ID/02085357	2 X E14	MAX 2 X 9W	2 X 800 LM	● NOIR	€ 40,00

GLAM

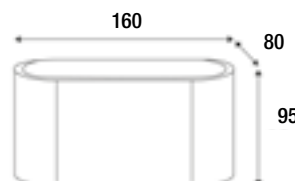

RÉF. ID	PUISSANCE	FLUX	T°	COULEUR	PRIX HTVA
ID/02682278	10W	450 LM	3000°K	● NOIR / OR	€ 119,00
ID/02682277	10W	680 LM	3000°K	● NOIR / ARGENT	€ 119,00

APPLIQUES MURALES

ODREY WALL



230V



Famille d'appliques simples ou doubles, Odrey permet une grande variété de déclinaisons dans des tons et des formes très tendances actuellement. Elles se marieront à la perfection avec la série de suspensions composables du même nom.

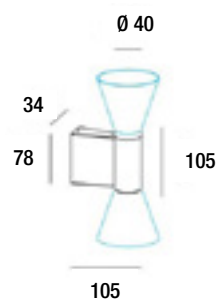
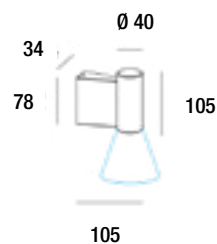

NEW

RÉF. ID	CULOT	PUISSANCE MAX	FLUX MAX	COULEUR	MATÉRIAU	PRIX HTVA
ID/03361742	GU10	MAX 9W	575 LM	● NOIR	ALUMINIUM	€ 84,00
ID/03361743	GU10	MAX 9W	575 LM	● DORE	ALUMINIUM	€ 84,00
ID/03361735	2 X GU10	MAX 2 X 9W	2 X 575 LM	● NOIR	ALUMINIUM	€ 94,00
ID/03361737	2 X GU10	MAX 2 X 9W	2 X 575 LM	● DORE	ALUMINIUM	€ 94,00

Disponible en suspension page 160
Disponible sur tracklight page 254

ODREY SHADE (REQUIS)



SHADE 3.0



SHADE 4.0



SHADE 5.0

NEW

RÉF. ID	FORME	COULEUR	DIMENSIONS MM	MATÉRIAU	PRIX HTVA
ID/03361722	SHADE 3.0	● NOIR	Ø 100 X 85	ALUMINIUM	€ 27,00
ID/03361723	SHADE 3.0	● OR	Ø 100 X 85	ALUMINIUM	€ 27,00
ID/03361724	SHADE 4.0	● NOIR	Ø 124 X 120	ALUMINIUM	€ 37,00
ID/03361725	SHADE 4.0	● OR	Ø 124 X 120	ALUMINIUM	€ 37,00
ID/03361726	SHADE 5.0	● NOIR	Ø 115 X 160	ALUMINIUM	€ 49,00
ID/03361727	SHADE 5.0	● OR	Ø 115 X 160	ALUMINIUM	€ 49,00



APPLIQUES MURALES

DARF 1

LED IP20 SWITCH O I IRC 80 ◀ A++ A ▶ 230V

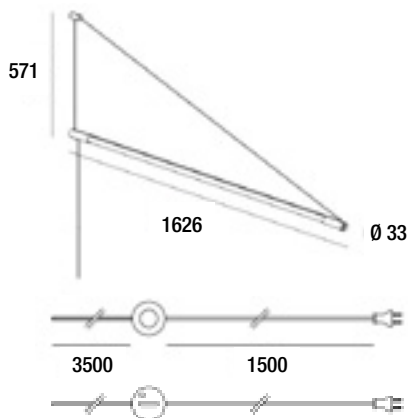

APPLIQUES MURALES

NEW

RÉF. ID	PUISSANCE	FLUX	T°	COULEUR	MATÉRIAU	DIMMABLE	PRIX HTVA
ID/03361317	25W	3300 LM	3000°K	● NOIR	ALUMINIUM	OUI	€ 275,00
ID/03361318	25W	3300 LM	3000°K	● NOIR	ALUMINIUM	NON	€ 222,00
ID/03361319	25W	3700 LM	4000°K	● NOIR	ALUMINIUM	NON	€ 222,00

Disponible en suspension page 187

MALTA

LED 3 ANS IP20 IRC ≥90 ✕ ◀ A++ A ▶ 230V

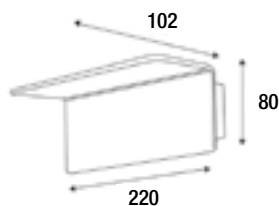

RÉF. ID	PUISSANCE	FLUX	T°	COULEUR	PRIX HTVA
ID/02223722	17W	1950 LM	3000°K	○ BLANC MAT	€ 170,00

APPLIQUES MURALES

MALTA 2

LED 3 ANS IP20 IRC ≥90 A++ A 230V

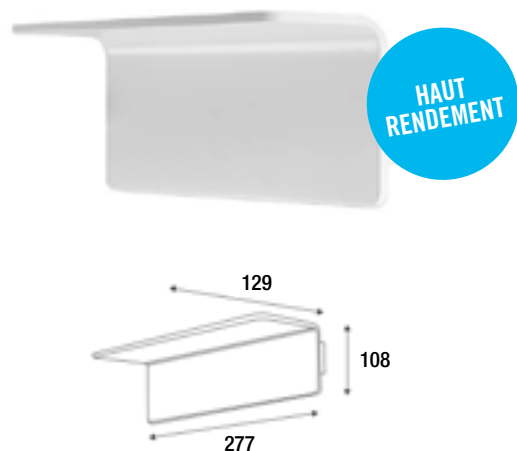

RÉF. ID	PUISSANCE	FLUX	T°	COULEUR	PRIX HTVA
ID/02682256	30W	3500 LM	3000°K	○ BLANC MAT	€ 190,00

STEP

LED IP20 IRC ≥90 A+ 230V

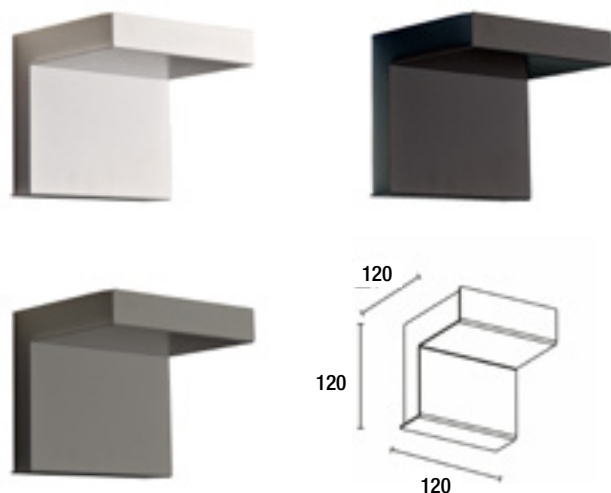

Le conseil de l'éclairagiste:

Dans certains espaces, il est difficile de placer un éclairage au plafond. C'est le cas, par exemple, d'une pièce avec un plafond en voutes. C'est alors qu'une applique à éclairage indirect puissant représente une solution de choix.

RÉF. ID	PUISSANCE	FLUX	T°	COULEUR	PRIX HTVA
ID/01881184	26W	3300 LM	3000°K	○ BLANC MAT	€ 289,00
ID/01881186	26W	3300 LM	3000°K	● NOIR MAT	€ 289,00
ID/01881188	26W	3300 LM	3000°K	● GRIS CIMENT	€ 289,00

APPLIQUES MURALES

KUPA

LED 3 ANS IP20 IRC ≥90     230V 



RÉF. ID	PUISSANCE	FLUX	T°	COULEUR	MATÉRIAU	PRIX HTVA
ID/02682261	3,5W	275 LM	3000°K	○ BLANC	ALUMINIUM	€ 65,00
ID/03383009	3.5W	275 LM	3000°K	● BLANC MAT/DORE	ALUMINIUM	€ 75,00
ID/03383008	3.5W	275 LM	3000°K	● NOIR/DORE	ALUMINIUM	€ 75,00

APPLIQUES MURALES

KAVA

LED 3 ANS IP20 IRC ≥90     230V 



RÉF. ID	PUISSANCE	FLUX	T°	COULEUR	MATÉRIAU	PRIX HTVA
ID/01089551	5W	320 LM	3000°K	○ BLANC	ALUMINIUM	€ 125,00
ID/03383042	5W	390 LM	3000°K	● BLANC MAT/DORE	ALUMINIUM	€ 125,00
ID/03383041	5W	390 LM	3000°K	● NOIR/DORE	ALUMINIUM	€ 125,00

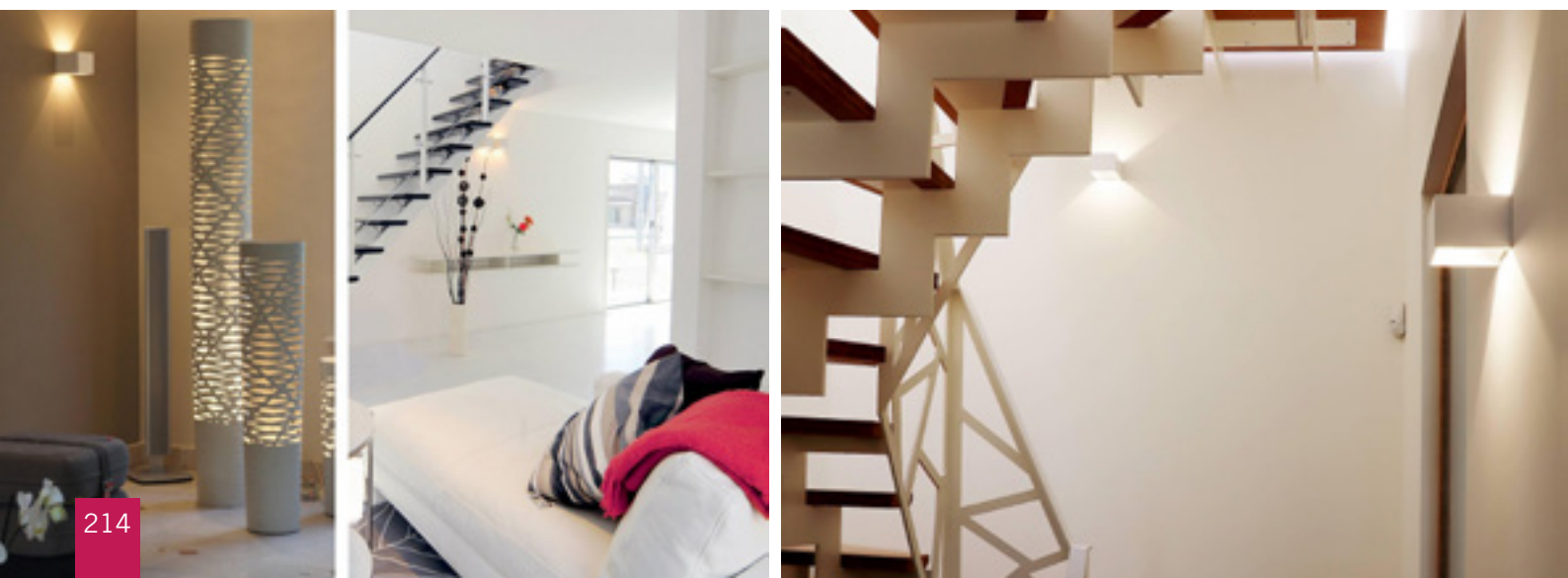

APPLIQUES MURALES

CUSCO

LED 5 ANS IP43 IRC ≥90 TRIAC ← A+ → 230V

- Angle de faisceau réglable de 1 à 60°

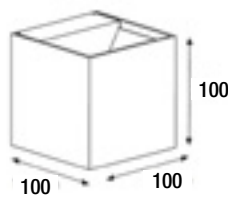

RÉF. ID	PUISSANCE	FLUX	T°	COULEUR	MATÉRIAU	PRIX HTVA
ID/02609960	2 X 5W	2 X 400 LM	2700°K	○ BLANC	ALUMINIUM	€ 95,00
ID/02609958	2 X 5W	2 X 400 LM	2700°K	● NOIR	ALUMINIUM	€ 95,00
ID/02609961	2 X 5W	2 X 400 LM	3000°K	○ BLANC	ALUMINIUM	€ 95,00
ID/02609959	2 X 5W	2 X 400 LM	3000°K	● NOIR	ALUMINIUM	€ 95,00

FULLA

LED 3 ANS IP20 IRC >90 TRIAC ← A++ A → 230V

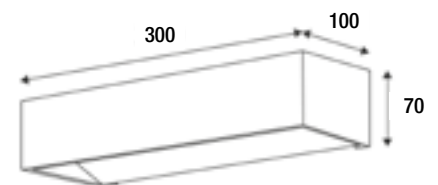

RÉF. ID	PUISSANCE	FLUX	T°	COULEUR	MATÉRIAU	PRIX HTVA
ID/02682263	2 X 7,5W	1200 LM	3000°K	○ BLANC	ALUMINIUM	€ 160,00

APPLIQUES MURALES

HEDI

LED 3 ANS IP20 IRC ≥90 DIM TO WARM TRIAC ← A++ A 230V

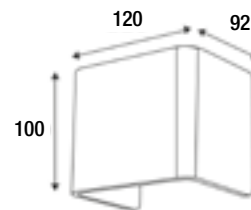

DIM-TO-WARM



APPLIQUES MURALES

RÉF. ID	PUISSANCE	FLUX	T°	COULEUR	MATÉRIAU	PRIX HTVA
ID/02682268	6W	440 LM	2000 - 3000°K	● MARBRE	ALUMINIUM	€ 130,00
ID/02682266	6W	440 LM	2000 - 3000°K	● BOIS CLAIR	ALUMINIUM	€ 120,00
ID/02682267	6W	440 LM	2000 - 3000°K	● BOIS FONCE	ALUMINIUM	€ 120,00
ID/02682264	6W	440 LM	2000 - 3000°K	○ BLANC MAT	ALUMINIUM	€ 120,00
ID/02682265	6W	440 LM	2000 - 3000°K	● ALUMINIUM POLI	ALUMINIUM	€ 130,00

APPLIQUES MURALES

LONGA

LED 3 ANS IP20 IRC >90 TRIAC ← A++ A 230V

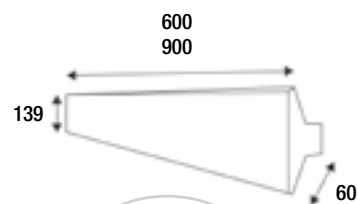

APPLIQUES MURALES

RÉF. ID	PUISSANCE	FLUX	T°	COULEUR	DIMENSIONS MM	PRIX HTVA
ID/02786421	2 X 12W	2600 LM	3000°K	○ BLANC	600 X 139 X 60	€ 220,00
ID/02786420	2 X 12W	2600 LM	3000°K	● NOIR	600 X 139 X 60	€ 220,00
ID/02786423	2 X 15W	3000 LM	3000°K	○ BLANC	900 X 139 X 60	€ 266,00
ID/02786422	2 X 15W	3000 LM	3000°K	● NOIR	900 X 139 X 60	€ 266,00

THIN

LED 5 ANS IP20 IRC 80 ← A++ A 230V

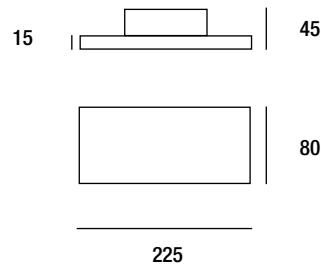

NEW

RÉF. ID	PUISSANCE	FLUX	T°	COULEUR	MATÉRIAU	PRIX HTVA
ID/03328586	6,4W	215 LM	3000°K	● NOIR	ALUMINIUM	€ 75,00

APPLIQUES MURALES

BOX MINI 2.0

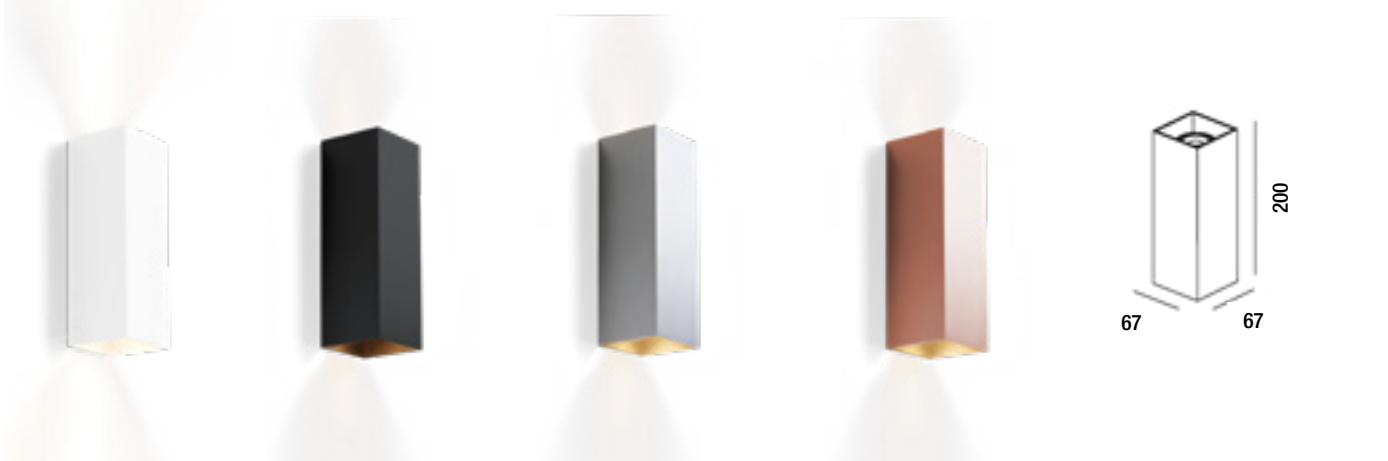

APPLIQUES MURALES



RÉF. ID	CULOT	PUISSANCE MAX	FLUX MAX	COULEUR	PRIX HTVA
ID/01606328	2 X GU10	MAX 2 X 9W	2 X 575 LM	○ BLANC	€ 75,00
ID/01606326	2 X GU10	MAX 2 X 9W	2 X 575 LM	● NOIR	€ 75,00
ID/01606327	2 X GU10	MAX 2 X 9W	2 X 575 LM	● ALU BROSSÉ	€ 77,00
ID/01888022	2 X GU10	MAX 2 X 9W	2 X 575 LM	● CUIVRE	€ 77,00

APPLIQUES MURALES

○ RAY MINI 2.0



APPLIQUES MURALES

RÉF. ID	CULOT	PUISSANCE MAX	FLUX MAX	COULEUR	PRIX HTVA
ID/01607133	2 X GU10	MAX 2 X 9W	2 X 575 LM	○ BLANC	€ 75,00
ID/01607131	2 X GU10	MAX 2 X 9W	2 X 575 LM	● NOIR	€ 75,00
ID/01607132	2 X GU10	MAX 2 X 9W	2 X 575 LM	● ALU BROSSÉ	€ 77,00
ID/01888023	2 X GU10	MAX 2 X 9W	2 X 575 LM	● CUIVRE	€ 77,00

APPLIQUES SALLE DE BAINS

VIEW

LED 5 ANS IP44 IRC >90 TRIAC A++ A 230V



APPLIQUES MURALES

RÉF. ID	PUISSANCE	FLUX	T°	COULEUR	MATÉRIAU	PRIX HTVA
ID/02628784	16W	870 LM	2700°K	○ BLANC	ALUMINIUM	€ 106,00
ID/02628787	16W	680 LM	2700°K	● NOIR	ALUMINIUM	€ 106,00
ID/02628782	16W	770 LM	2700°K	● ALUMINIUM BROSSÉ	ALUMINIUM	€ 134,00
ID/02628785	16W	930 LM	3000°K	○ BLANC	ALUMINIUM	€ 106,00
ID/02628788	16W	730 LM	3000°K	● NOIR	ALUMINIUM	€ 106,00
ID/02628783	16W	820 LM	3000°K	● ALUMINIUM BROSSÉ	ALUMINIUM	€ 134,00
ID/02628786	16W	1010 LM	4000°K	○ BLANC	ALUMINIUM	€ 106,00
ID/02949774	16W	790 LM	4000°K	● NOIR	ALUMINIUM	€ 106,00

VIEW FIXATION ÉTAGÈRE



RÉF. ID	COULEUR	PRIX HTVA
ID/02628791	○ BLANC	€ 9,00

APPLIQUES SALLE DE BAINS

VIEW 900

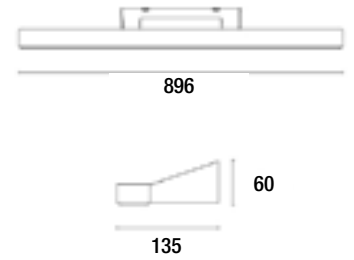

RÉF. ID	PUISSANCE	FLUX	T°	COULEUR	MATÉRIAU	PRIX HTVA
ID/03298584	30W	1820 LM	2700°K	○ BLANC	ALUMINIUM	€ 155,00
ID/03298586	30W	1360 LM	2700°K	● NOIR	ALUMINIUM	€ 155,00
ID/02628789	30W	1880 LM	3000°K	○ BLANC	ALUMINIUM	€ 155,00
ID/02628790	30W	1460 LM	3000°K	● NOIR	ALUMINIUM	€ 155,00
ID/03298585	30W	1970 LM	4000°K	○ BLANC	ALUMINIUM	€ 155,00
ID/02949773	30W	1580 LM	4000°K	● NOIR	ALUMINIUM	€ 155,00

APPLIQUES MURALES

AMUR

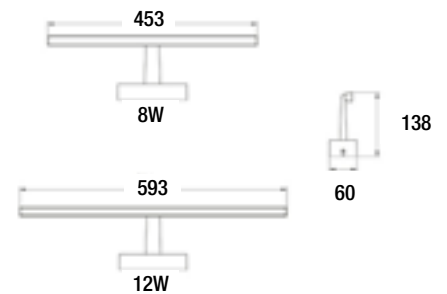

NEW

RÉF. ID	PUISSANCE	FLUX	T°	COULEUR	MATÉRIAU	PRIX HTVA
ID/02878254	8W	450 LM	3000°K	○ BLANC	SYNTHÉTIQUE	€ 57,00
ID/02878253	8W	450 LM	3000°K	● NOIR	SYNTHÉTIQUE	€ 57,00
ID/02878255	8W	450 LM	3000°K	● CHROME	SYNTHÉTIQUE	€ 65,00
ID/02878257	12W	795 LM	3000°K	○ BLANC	SYNTHÉTIQUE	€ 65,00
ID/02878256	12W	795 LM	3000°K	● NOIR	SYNTHÉTIQUE	€ 65,00
ID/02878258	12W	795 LM	3000°K	● CHROME	SYNTHÉTIQUE	€ 75,00

APPLIQUES SALLE DE BAINS

BETHAN

LED IP21  IRC 80  ←   230V 

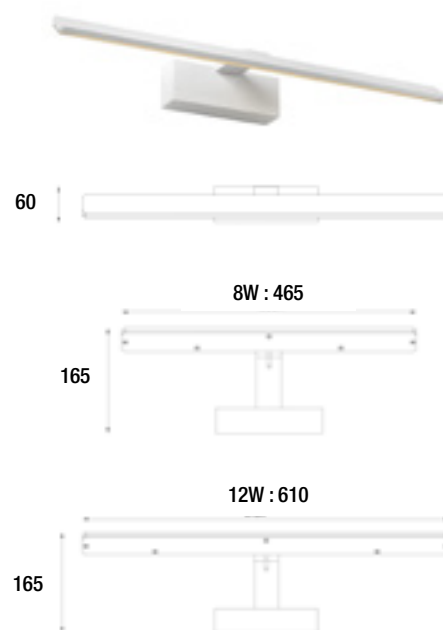

RÉF. ID	PUISSANCE	FLUX	T°	COULEUR	MATÉRIAU	PRIX HTVA
ID/02539726	8W	685 LM	3000°K	○ BLANC MAT	ALUMINIUM	€ 78,00
ID/02539725	12W	1008 LM	3000°K	○ BLANC MAT	ALUMINIUM	€ 97,00

EVIA

LED IP44  IRC ≥90  ←   230V 







NEW

RÉF. ID	PUISSANCE	FLUX	T°	COULEUR	MATÉRIAU	PRIX HTVA
ID/03224865	5W	350 LM	2700°K	○ BLANC	ABS	€ 29,00
ID/03224864	5W	350 LM	2700°K	● NOIR	ABS	€ 29,00
ID/03224863	5W	350 LM	2700°K	● CHROME	ABS	€ 29,00
ID/03224868	8W	600 LM	2700°K	○ BLANC	ABS	€ 49,00
ID/03224867	8W	600 LM	2700°K	● NOIR	ABS	€ 49,00
ID/03224866	8W	600 LM	2700°K	● CHROME	ABS	€ 49,00

APPLIQUES SALLE DE BAINS

JEDI

LED IP54   ←   230V 

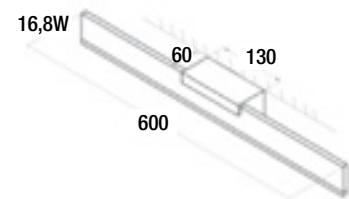
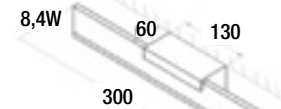

APPLIQUES MURALES

RÉF. ID	PUISSANCE	FLUX	T°	COULEUR	MATÉRIAU	PRIX HTVA
ID/01554766	8,4W	840 LM	3000°K	○ BLANC MAT	ALUMINIUM	€ 171,00
ID/01554767	16,8W	1680 LM	3000°K	○ BLANC MAT	ALUMINIUM	€ 214,00

MIRO

LED 3 ANS IP20  IRC >80  ←   230V 

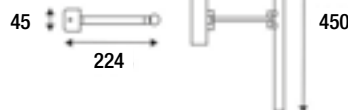

-Orientation verticale pour un maximum de 190°

RÉF. ID	PUISSANCE	FLUX	T°	COULEUR	MATÉRIAU	PRIX HTVA
ID/02510160	9W	560 LM	3000°K	○ BLANC MAT	ALUMINIUM	€ 100,00

APPLIQUES SALLE DE BAINS

MIRBA 1

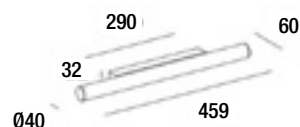

NEW

RÉF. ID	PUISSANCE	FLUX	T°	COULEUR	MATÉRIAU	PRIX HTVA
ID/02509553	9W	560 LM	2700°K	○ BLANC	ALUMINIUM	€ 175,00
ID/02509554	9W	560 LM	3000°K	○ BLANC	ALUMINIUM	€ 175,00
ID/03361703	9W	560 LM	2700°K	● NOIR/BLANC	ALUMINIUM	€ 175,00
ID/03361704	9W	506 LM	3000°K	● NOIR/BLANC	ALUMINIUM	€ 175,00

APPLIQUES MURALES



APPLIQUES SALLE DE BAINS

MIRBA 2

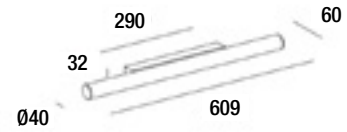

NEW

RÉF. ID	PUISSANCE	FLUX	T°	COULEUR	MATÉRIAU	PRIX HTVA
ID/02509555	12W	820 LM	2700°K	○ BLANC	ALUMINIUM	€ 207,00
ID/02509556	12W	820 LM	3000°K	○ BLANC	ALUMINIUM	€ 207,00
ID/03361705	12W	820 LM	2700°K	● NOIR/BLANC	ALUMINIUM	€ 207,00
ID/03361706	12W	820 LM	3000°K	● NOIR/BLANC	ALUMINIUM	€ 207,00

APPLIQUES MURALES

MIRBA 3

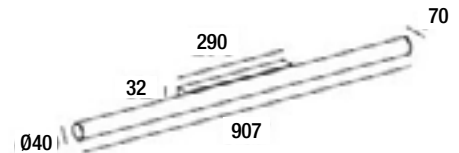

NEW

RÉF. ID	PUISSANCE	FLUX	T°	COULEUR	MATÉRIAU	PRIX HTVA
ID/02509557	18W	1050 LM	2700°K	○ BLANC	ALUMINIUM	€ 239,00
ID/02509558	18W	1050 LM	3000°K	○ BLANC	ALUMINIUM	€ 239,00
ID/03361707	18W	1050 LM	2700°K	● NOIR/BLANC	ALUMINIUM	€ 239,00
ID/03361708	18W	1050 LM	3000°K	● NOIR/BLANC	ALUMINIUM	€ 239,00

LAMPES À POSER

PAGES 226 À 245

Complémentaires à l'éclairage général, les lampes à poser et lampadaires créent des ambiances subtiles tout en apportant une touche déco intéressante à tout intérieur.



LAMPES À POSER



LORIN TABLE
228



LORIN FLOOR
228



NEW

TANNER L
229



NEW

TANNER O
229



ARTHUR
230



ARTHUR FLOOR
230



THOR TABLE
231



THOR FLOOR
231



ORRIN TABLE
232



NORDIC
232



KNULLE
233



CONA TABLE
234



CONA FLOOR
234



HESTER TABLE
235



HESTER FLOOR
235



PHILINE TABLE
236



PHILINE FLOOR
236



BERGAMO
237



ZOZY
237



ZENITH
238



CHAMPION
238



SKANSKA TABLE
239



SKANSKA FLOOR
239



MIKA TABLE
240



MIKA FLOOR
240



PURE FLOOR M
241



PURE FLOOR H
241



BANKER
242



JOE
242



NEW

MOON
244



NEW

MANU
245

LAMPES À POSER

LORIN TABLE

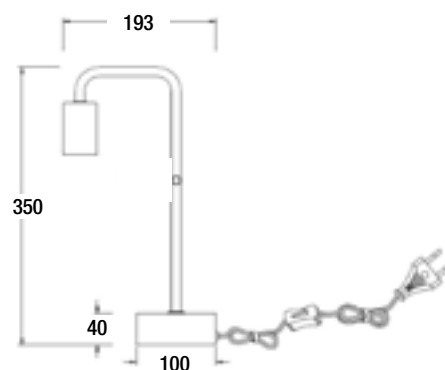

RÉF. ID	CULOT	PUISSANCE MAX	FLUX MAX	COULEUR	MATÉRIAU	PRIX HTVA
ID/02772959	E27	MAX 9W	800 LM	● NOIR	ACIER	€ 29,00

LORIN FLOOR

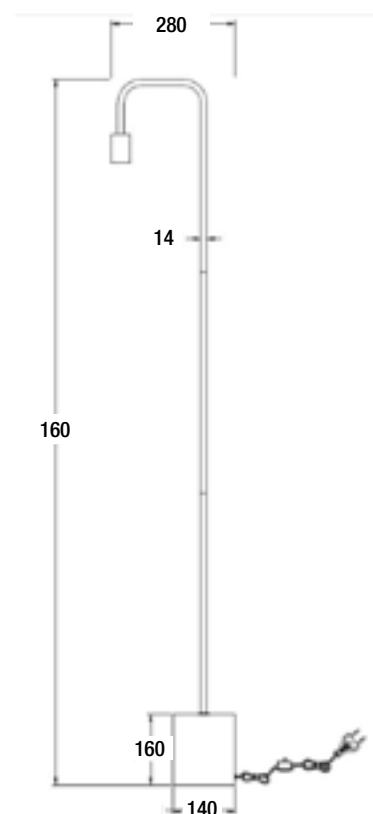

RÉF. ID	CULOT	PUISSANCE MAX	FLUX MAX	COULEUR	MATÉRIAU	PRIX HTVA
ID/02772968	E27	MAX 9W	800 LM	● NOIR	ACIER	€ 83,00



TANNER L

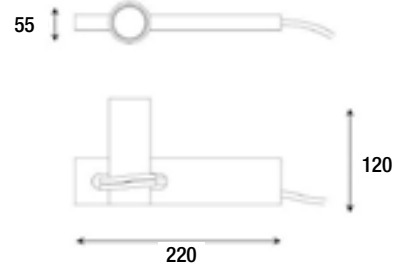

NEW

RÉF. ID	CULOT	PUISSANCE MAX	FLUX MAX	COULEUR	MATÉRIAU	PRIX HTVA
ID/03382661	E27	MAX 9W	800 LM	● NOIR/BETON	BETON/ALUMINIUM	€ 43,00
ID/03382662	E27	MAX 9W	800 LM	● NOIR/BOIS	BOIS/ALUMINIUM	€ 39,00

Disponible en suspension page 164

Disponible en applique page 203

TANNER O

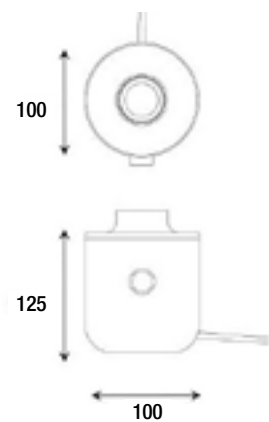

NEW

RÉF. ID	CULOT	PUISSANCE MAX	FLUX MAX	COULEUR	MATÉRIAU	PRIX HTVA
ID/03382663	E27	MAX 9W	800 LM	● BETON/DORE	BETON/ALUMINIUM	€ 46,00
ID/03382664	E27	MAX 9W	800 LM	● BETON/NOIR	BETON/ALUMINIUM	€ 46,00



LAMPES À POSER

ARTHUR

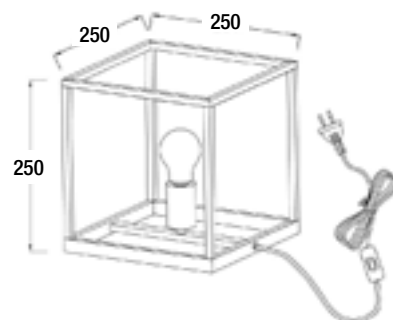

RÉF. ID	CULOT	PUISSANCE MAX	FLUX MAX	COULEUR	MATÉRIAU	PRIX HTVA
ID/02611986	E27	MAX 9W	800LM	● NOIR	MÉTAL	€ 40,00

ARTHUR FLOOR

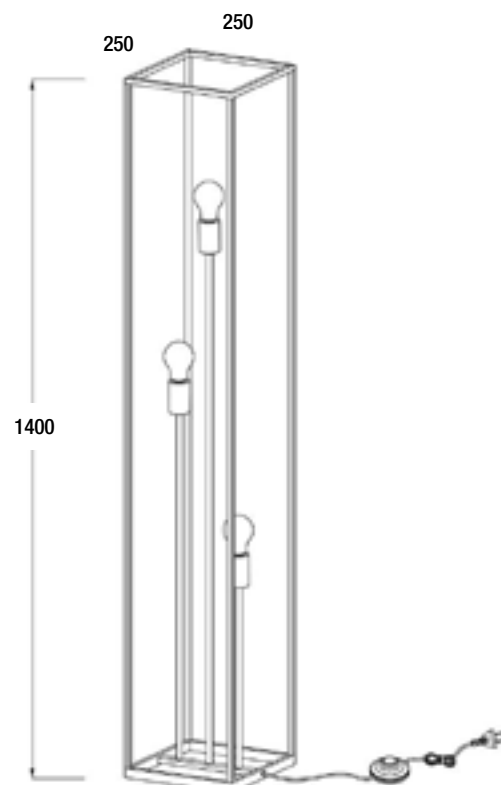

RÉF. ID	CULOT	PUISSANCE MAX	FLUX MAX	COULEUR	MATÉRIAU	PRIX HTVA
ID/02773195	3 X E27	3 X MAX 9W	3 X 800LM	● NOIR	MÉTAL	€ 132,00

Disponible en plafonnier 120
 Disponible en suspension page 165
 Disponible en applique page 206

LAMPES À POSER



THOR TABLE

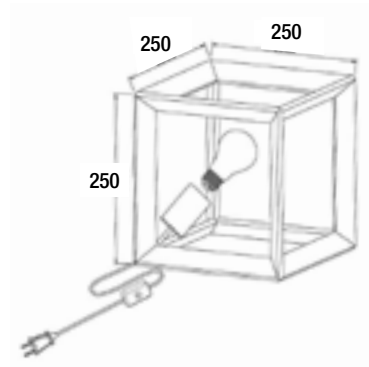

RÉF. ID	CULOT	PUISSANCE MAX	FLUX MAX	COULEUR	MATÉRIAU	PRIX HTVA
ID/02612165	E27	MAX 9W	800LM	● FER GRIS	MÉTAL	€ 114,00

THOR FLOOR

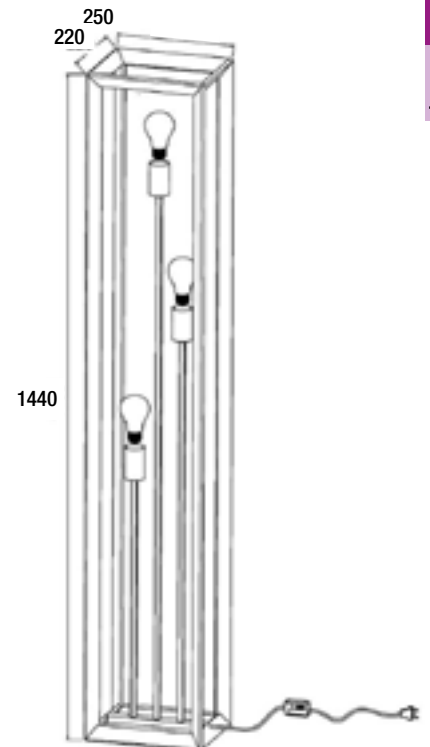

RÉF. ID	CULOT	PUISSANCE MAX	FLUX MAX	COULEUR	MATÉRIAU	PRIX HTVA
ID/02612167	3 X E27	3 X MAX 9W	3 X 800LM	● FER GRIS	MÉTAL	€ 248,00

Disponible en plafonnier 121
 Disponible en suspension page 166
 Disponible en applique page 207



LAMPES À POSER

ORRIN TABLE

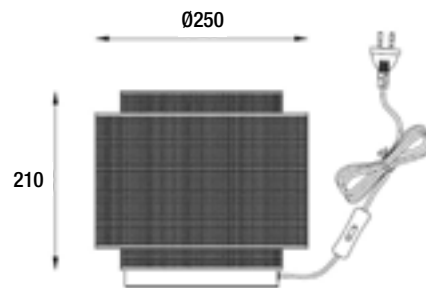

RÉF. ID	CULOT	PUISSANCE MAX	FLUX MAX	COULEUR	MATÉRIAU	PRIX HTVA
ID/02695327	E27	MAX 9W	800 LM	● NOIR	MÉTAL	€ 53,00

Disponible en suspension page 172

NORDIC



RÉF. ID	CULOT	PUISSANCE MAX	FLUX MAX	COULEUR	MATÉRIAU	PRIX HTVA
ID/01609900	E14	MAX 9W	800 LM	○ BLANC	BOIS	€ 59,00

LAMPES À POSER

KNULLE

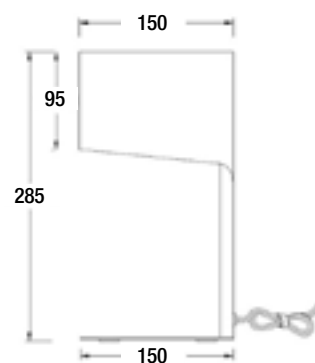

LAMPES À POSER

RÉF. ID	CULOT	PUISSANCE MAX	FLUX MAX	COULEUR	MATÉRIAU	PRIX HTVA
ID/02772957	E14	MAX 9W	800 LM	○ BLANC	MÉTAL	€ 29,00
ID/02772956	E14	MAX 9W	800 LM	● NOIR	MÉTAL	€ 29,00
ID/02772958	E14	MAX 9W	800 LM	● GRIS	MÉTAL	€ 29,00

LAMPES À POSER

CONA TABLE



RÉF. ID	CULOT	PUISSANCE MAX	FLUX MAX	COULEUR	MATÉRIAU	PRIX HTVA
ID/01610192	E14	MAX 9W	800 LM	○ BLANC	MÉTAL	€ 58,00

CONA FLOOR

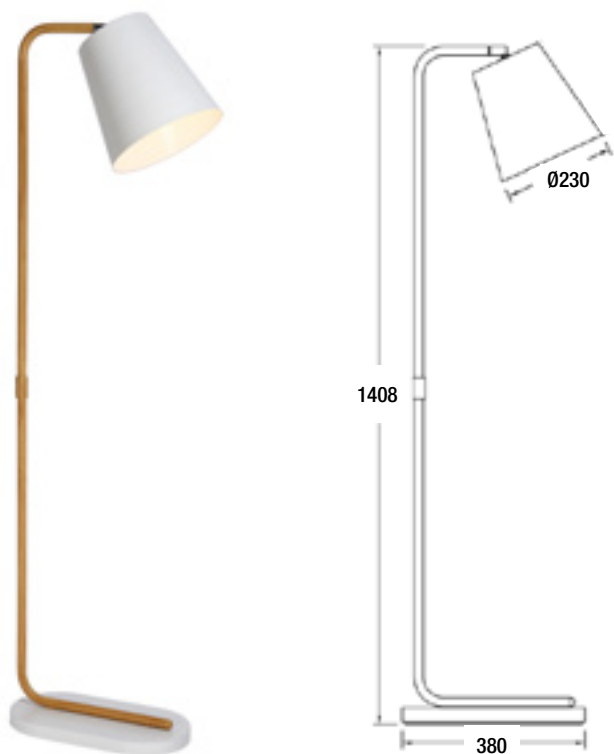

RÉF. ID	CULOT	PUISSANCE MAX	FLUX MAX	COULEUR	MATÉRIAU	PRIX HTVA
ID/01610193	E27	MAX 9W	800 LM	○ BLANC	MÉTAL	€ 140,00

LAMPES À POSER

LAMPES À POSER

HESTER TABLE

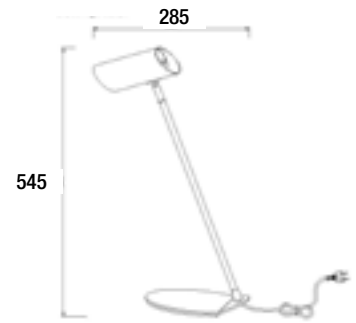

RÉF. ID	CULOT	PUISSANCE MAX	FLUX MAX	COULEUR	MATÉRIAU	PRIX HTVA
ID/02509814	GU10	MAX 9W	575 LM	○ BLANC	MÉTAL	€ 49,00
ID/02509813	GU10	MAX 9W	575 LM	● ANTHRACITE	MÉTAL	€ 49,00

HESTER FLOOR



RÉF. ID	CULOT	PUISSANCE MAX	FLUX MAX	COULEUR	MATÉRIAU	PRIX HTVA
ID/02509816	GU10	MAX 9W	575 LM	○ BLANC	MÉTAL	€ 59,00
ID/02509815	GU10	MAX 9W	575 LM	● ANTHRACITE	MÉTAL	€ 59,00



LAMPES À POSER

PHILINE TABLE

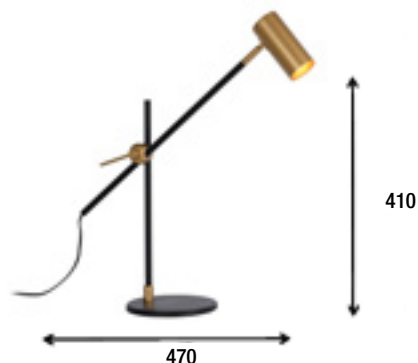

RÉF. ID	CULOT	PUISSANCE MAX	FLUX MAX	COULEUR	MATÉRIAU	PRIX HTVA
ID/02773216	GU10	MAX 5W	575 LM	● NOIR / OR	ACIER	€ 77,00

PHILINE FLOOR

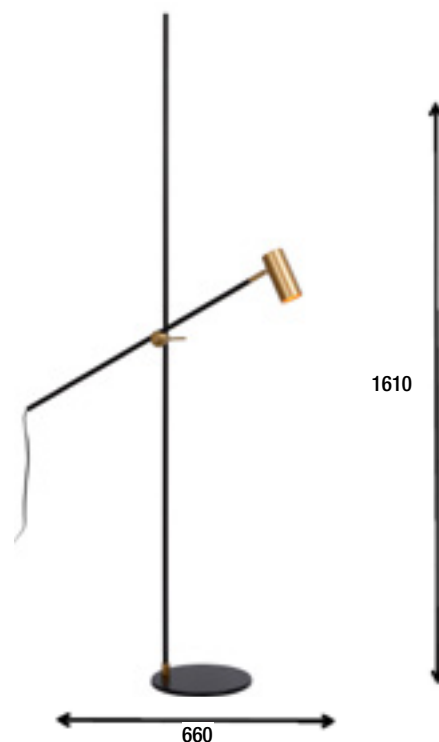

RÉF. ID	CULOT	PUISSANCE MAX	FLUX MAX	COULEUR	MATÉRIAU	PRIX HTVA
ID/02773217	GU10	MAX 5W	575 LM	● NOIR / OR	ACIER	€ 116,00

LAMPES À POSER

BERGAMO

LED 5 ANS IP20 SWITCH 0 1 IRC 80 ↓ A 230V

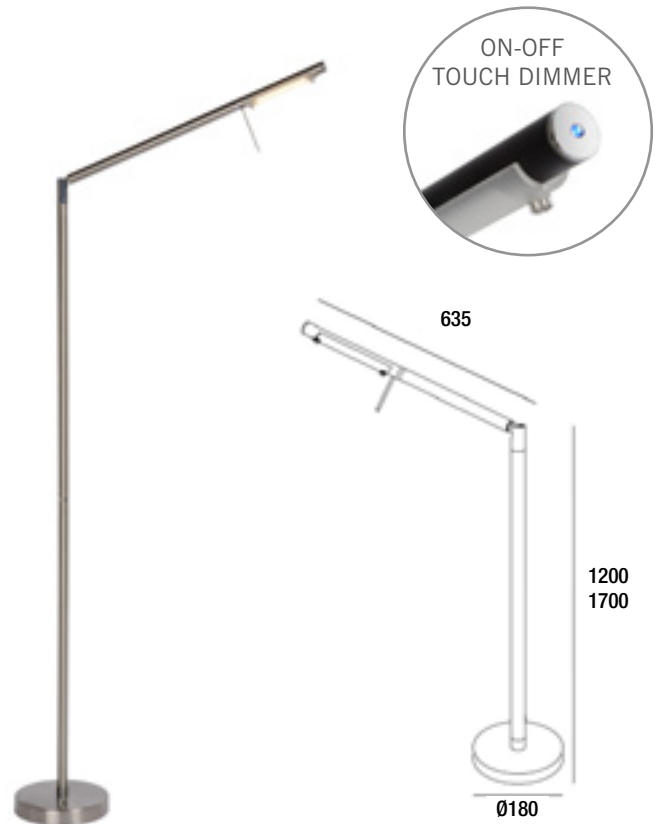

RÉF. ID	PUISSANCE	FLUX	T°	COULEUR	MATÉRIAU	PRIX HTVA
ID/02695349	6W	600 LM	3000°K	● NOIR	MÉTAL	€ 157,00
ID/01356797	6W	600 LM	3000°K	● CHROME DÉPOLI	MÉTAL	€ 157,00

ZOZY

LED 5 ANS IP20 SWITCH 0 1 IRC 80 ↓ A 230V

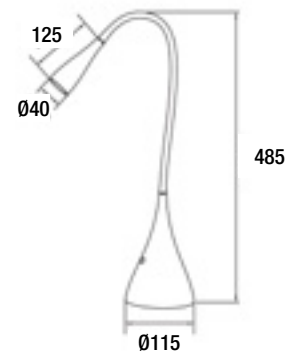

RÉF. ID	PUISSANCE	FLUX	T°	COULEUR	MATÉRIAU	PRIX HTVA
ID/01317213	3W	300 LM	3000°K	○ BLANC	SYNTHÉTIQUE	€ 40,00
ID/01317212	3W	300 LM	3000°K	● NOIR	SYNTHÉTIQUE	€ 40,00



LAMPES À POSER

ZENITH

LED IP20 SWITCH 0 1 IRC 80 A+ 230V

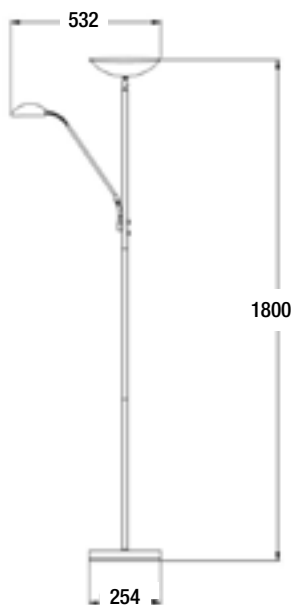

Le conseil de l'éclairagiste:

Les lampadaires-liseuses combinent deux fonctionnalités au sein d'un même luminaire. Une source lumineuse indirecte permet un éclairage général de la pièce et la liseuse orientable offre un éclairage plus doux mais efficace pour lire confortablement.



RÉF. ID	PUISSANCE	FLUX	T°	COULEUR	MATÉRIAU	PRIX HTVA
---------	-----------	------	----	---------	----------	-----------

ID/02695370	20 W + 4W	1600 LM + 320 LM	3000°K	● NOIR	MÉTAL	€ 74,00
-------------	-----------	------------------	--------	--------	-------	---------

ID/02612018	20 W + 4W	1600 LM + 320 LM	3000°K	● CHROME DÉPOLI	MÉTAL	€ 74,00
-------------	-----------	------------------	--------	-----------------	-------	---------

CHAMPION

LED 5 ANS IP20 SWITCH 0 1 IRC 80 A+ 230V



RÉF. ID	PUISSANCE	FLUX	T°	COULEUR	MATÉRIAU	PRIX HTVA
---------	-----------	------	----	---------	----------	-----------

ID/02325433	20 W + 4W	1600 LM + 320 LM	3000°K	● NOIR	MÉTAL	€ 99,00
-------------	-----------	------------------	--------	--------	-------	---------

ID/02325432	20 W + 4W	1600 LM + 320 LM	3000°K	● CHROME DÉPOLI	MÉTAL	€ 99,00
-------------	-----------	------------------	--------	-----------------	-------	---------

ID/02612019	20 W + 4W	1600 LM + 320 LM	3000°K	● BRONZE	MÉTAL	€ 99,00
-------------	-----------	------------------	--------	----------	-------	---------

LAMPES À POSER

SKANSKA TABLE

LED 5 ANS IP20 SWITCH O I IRC 80 A 230V

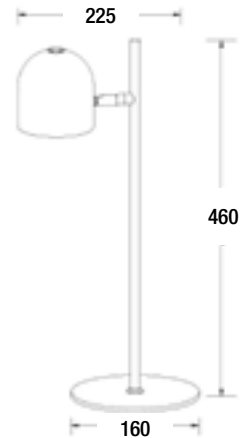

RÉF. ID	PUISSANCE	FLUX	T°	COULEUR	MATÉRIAU	PRIX HTVA
ID/01908743	5W	320 LM	3000°K	○ BLANC	MÉTAL	€ 78,00
ID/01908742	5W	320 LM	3000°K	● NOIR	MÉTAL	€ 78,00

SKANSKA FLOOR

LED 5 ANS IP20 SWITCH O I IRC 80 A 230V

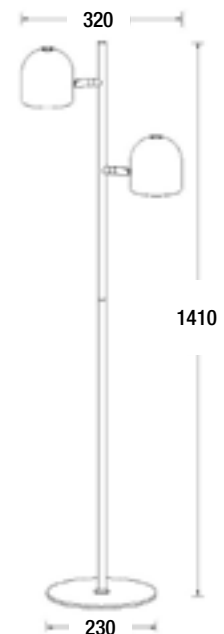
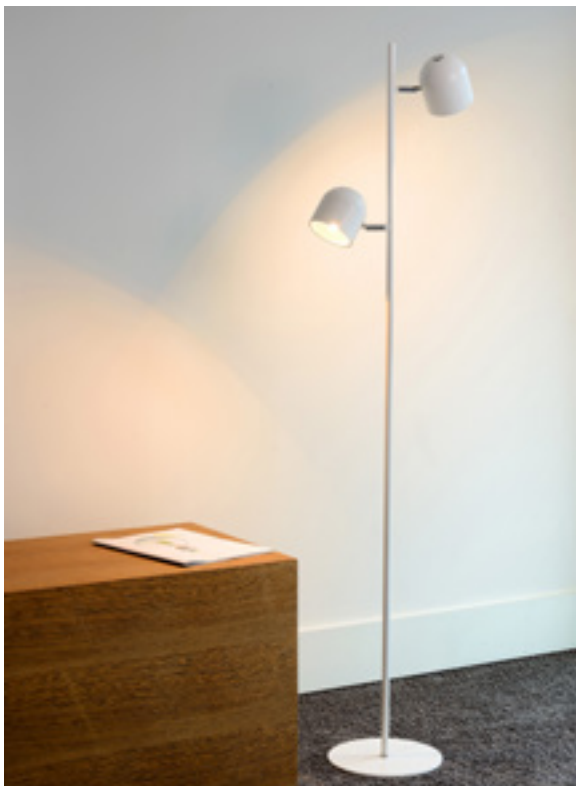

RÉF. ID	PUISSANCE	FLUX	T°	COULEUR	MATÉRIAU	PRIX HTVA
ID/01908749	2 X 5W	2 X 450 LM	2700°K	○ BLANC	MÉTAL	€ 140,00
ID/01908748	2 X 5W	2 X 450 LM	2700°K	● NOIR	MÉTAL	€ 140,00

LAMPES À POSER

MIKA TABLE

LED 3 ANS IP20 SWITCH 0 I ↓ A++ 230V

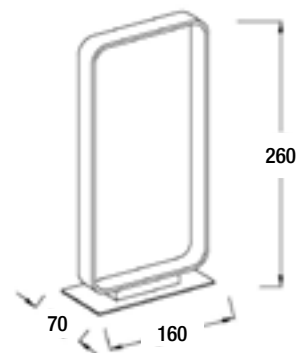

RÉF. ID	PUISSANCE	FLUX	T°	COULEUR	MATÉRIAU	PRIX HTVA
ID/02773007	5W	375 LM	3000°K	● NOIR	ACIER	€ 60,00

MIKA FLOOR

LED 3 ANS IP20 SWITCH 0 I ↓ A++ 230V

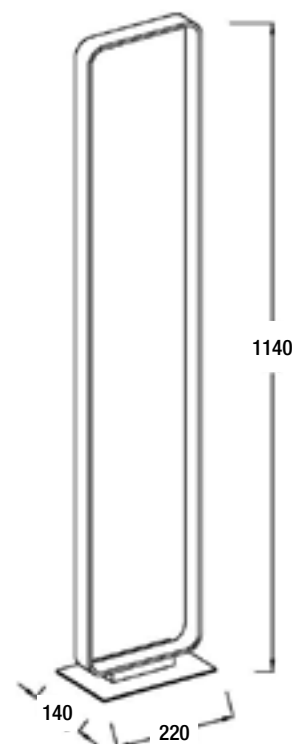

RÉF. ID	PUISSANCE	FLUX	T°	COULEUR	MATÉRIAU	PRIX HTVA
ID/02773008	2 X 8W	2 X 600 LM	3000°K	● NOIR	ACIER	€ 157,00

LAMPES À POSER

LAMPES À POSER

PURE FLOOR M

LED IP20 IRC 80    230V 

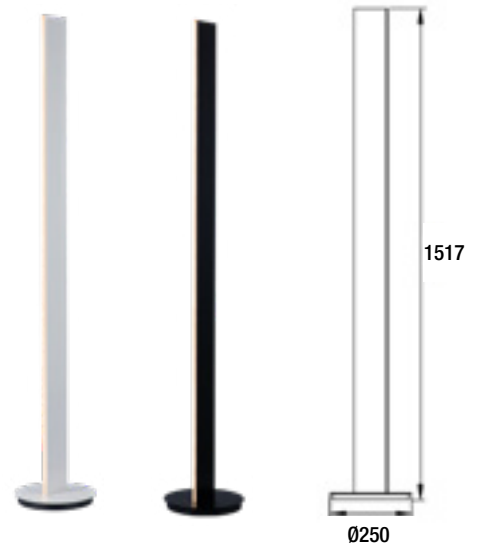

RÉF. ID	PUISSANCE	FLUX	T°	COULEUR	MATÉRIAU	PRIX HTVA
ID/02877798	26W	1820 LM	3000°K	○ BLANC	ALUMINIUM	€ 350,00
ID/02877803	26W	1820 LM	3000°K	● NOIR	ALUMINIUM	€ 350,00
ID/02877794	26W	1820 LM	3000°K	● BRONZE	ALUMINIUM	€ 350,00

PURE FLOOR H

LED IP20 IRC 80    230V 

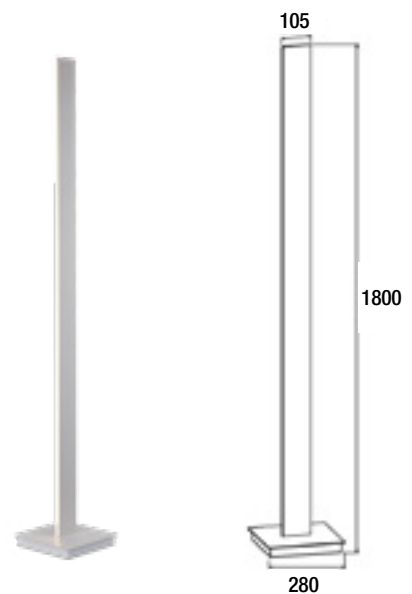

RÉF. ID	PUISSANCE	FLUX	T°	COULEUR	MATÉRIAU	PRIX HTVA
ID/02879043	32W	2590 LM	3000°K	○ BLANC	ALUMINIUM	€ 575,00
ID/02879047	32W	2590 LM	3000°K	● NOIR	ALUMINIUM	€ 575,00

LAMPES À POSER

BANKER

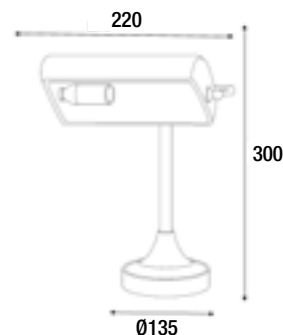

LAMPES À POSER



RÉF. ID	CULOT	PUISSANCE MAX	FLUX MAX	COULEUR	MATÉRIAU	PRIX HTVA
ID/00547510	E14	MAX 9W	800 LM	● VERT	MÉTAL	€ 50,00

JOE

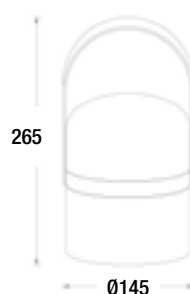

Le conseil de l'éclairagiste:

Grâce à la technologie led et aux dernières évolutions des batteries, les lampes baladeuses représentent aujourd'hui une solution lumineuse particulièrement flexible et fiable. Pour, par exemple à la fois, une utilisation classique en lampe de chevet et une utilisation ponctuelle en lampe d'appoint lors des soirées en extérieur.

RÉF. ID	PUISSANCE	FLUX	T°	COULEUR	MATÉRIAU	PRIX HTVA
ID/02085335	3W	278 LM	2800°K	○ BLANC	PVC	€ 78,00



LAMPES À POSER

MOON



- Luminaire portable avec interrupteur permettant trois niveaux d'éclairage (25%, 50% et 100%)
- Batterie rechargeable via prise USB.
- Temps de charge 5 heures avec une autonomie de 5 heures à 100%, 10 heures à 50% et 20 heures à 25% de luminosité.
- Livré avec câble USB
- Chargeur non compris à commander séparément
- Bases non comprises à commander séparément



NEW

RÉF. ID	PUISSANCE	FLUX	T°	COULEUR	MATÉRIAU	PRIX HTVA
ID/03383036	1.5W	170 LM	2700°K	● CUIVRE BROSSE	ALUMINIUM	€ 119,00
ID/03383035	1.5W	170 LM	2700°K	○ BLANC MAT	ALUMINIUM	€ 90,00
ID/03383034	1.5W	170 LM	2700°K	● NOIR MAT	ALUMINIUM	€ 90,00
ID/03383033	1.5W	170 LM	2700°K	● CHROME	ALUMINIUM	€ 109,00

ACCESSOIRES MOON



NEW

RÉF. ID	ACCESSOIRES	PRIX HTVA
ID/03383040	CHARGEUR USB BLANC	€ 18,00
ID/03383039	BASE + FILIN DE SUSPENSION CHROME	€ 36,00
ID/03383038	BASE LAMPE DE BUREAU NOIR	€ 45,00
ID/03383037	BASE AIMANTEE NOIR	€ 25,00
ID/03382891	CHARGEUR USB MULTI BLANC	€ 75,00



MANU

LED

3
ANS

IP65

IRC
80



A++
A

230V



LAMPES À POSER



- Luminaire portable.
- Diffuseur en polycarbonate opalin.
- Câble 3m et prise fournis.

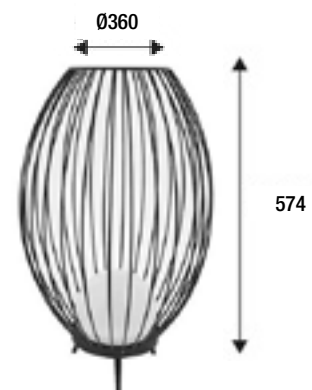

NEW

RÉF. ID	PUISSANCE	FLUX	T°	COULEUR	MATÉRIAU	PRIX HTVA
ID/03382905	12W	1538 LM	3000°K	● NOIR	ALUMINIUM	€ 153,00

RAILS & TRACK LIGHTS

PAGES 246 À 289

Différents types de rails existent pour tantôt solutionner un soucis d'arrivée électrique mal placée, tout en multipliant le potentiel de sources lumineuses (chez un particulier par exemple) ou pour tantôt mettre en lumière de façon modulable et polyvalente des espaces commerciaux et culturels (magasins de vêtements, showrooms, supermarchés et musées, par exemple). A côté de l'aspect purement fonctionnel, l'esthétique des rails et track lights leur confère un côté très tendance actuellement.



RAILS & TRACK LIGHTS 1 PHASE



RAILS & TRACK LIGHTS 3 PHASES

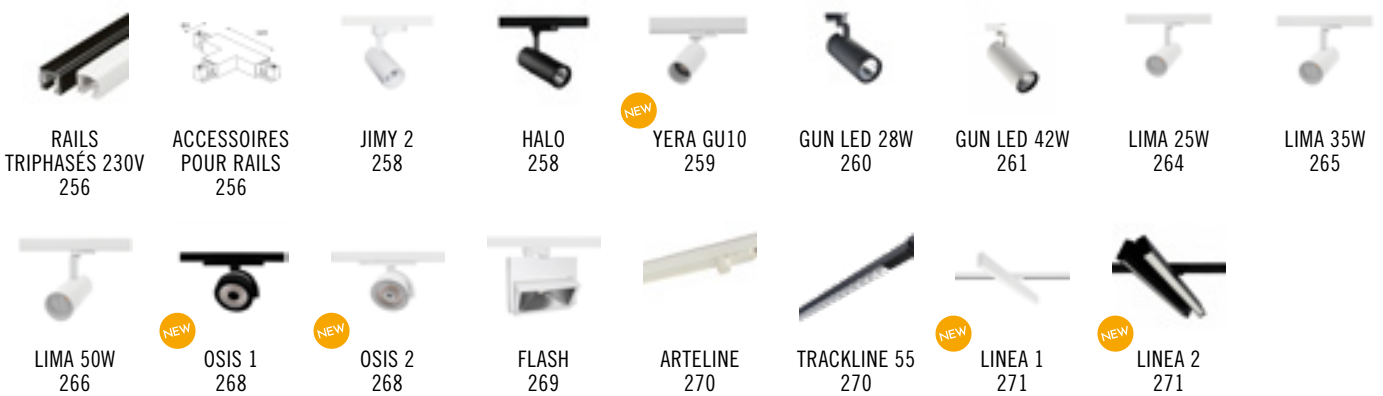

RAILS & TRACK LIGHTS 48V



RAILS 1 PHASE

RAILS MONOPHASÉS 230V



RÉF. ID	COULEUR	LONGUEUR MM	PRIX HTVA
ID/01721766	● NOIR	1 000	€ 28,00
ID/01441500	○ BLANC	1 000	€ 28,00
ID/01441501	● ALU	1 000	€ 28,00
ID/01721767	● NOIR	2 000	€ 55,00
ID/01056363	○ BLANC	2 000	€ 55,00
ID/01056364	● ALU	2 000	€ 55,00
ID/02748636	● NOIR	3 000	€ 87,00
ID/02748637	○ BLANC	3 000	€ 87,00
ID/02748638	● ALU	3 000	€ 87,00



- Rail apparent
- Tension secteur 230/250V
- Le raccordement au monophasé autorise une intensité totale de 16A, qui correspond à 3680VA
- Le rail peut supporter une charge de 4kg/m
- Pour une charge de 7kg, la distance entre les fixations doit être ramenée à 500mm

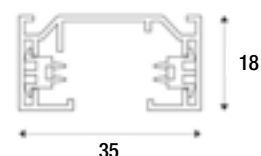









Le conseil de l'éclairagiste:
Plus léger et compact que le rail 3 phases, le rail 1 phase est une solution modulable et évolutive de choix dans les habitations privées, notamment dans le cas d'arrivées électriques mal positionnées.

ACCESSOIRES POUR RAILS

RÉF. ID	COULEUR	TYPE	PRIX HTVA
ID/01721768	● NOIR	ALIMENTATION GAUCHE	€ 7,50
ID/01056365	○ BLANC	ALIMENTATION GAUCHE	€ 7,50
ID/01056366	● ALU	ALIMENTATION GAUCHE	€ 7,50
ID/01721769	● NOIR	ALIMENTATION DROITE	€ 7,50
ID/01056367	○ BLANC	ALIMENTATION DROITE	€ 7,50
ID/01056368	● ALU	ALIMENTATION DROITE	€ 7,50
ID/01721770	● NOIR	ANGLE 90° EXTERIEUR	€ 13,00
ID/01056369	○ BLANC	ANGLE 90° EXTERIEUR	€ 13,00
ID/01056370	● ALU	ANGLE 90° EXTERIEUR	€ 13,00
ID/01721771	● NOIR	ANGLE 90° INTERIEUR	€ 13,00
ID/01056371	○ BLANC	ANGLE 90° INTERIEUR	€ 13,00
ID/01056372	● ALU	ANGLE 90° INTERIEUR	€ 13,00



ACCESSOIRES POUR RAILS

RÉF. ID	COULEUR	TYPE	PRIX HTVA	
ID/01721774	● NOIR	CONNECTEUR ELECTRIQUE	€ 5,50	
ID/01056377	○ BLANC	CONNECTEUR ELECTRIQUE	€ 5,50	
ID/01056378	● ALU	CONNECTEUR ELECTRIQUE	€ 5,50	
ID/01721775	● NOIR	ALIMENTATION CENTRALE	€ 14,00	
ID/01056379	○ BLANC	ALIMENTATION CENTRALE	€ 14,00	
ID/01056380	● ALU	ALIMENTATION CENTRALE	€ 14,00	
ID/01721772	● NOIR	CONNECTEUR T	€ 16,50	
ID/01056373	○ BLANC	CONNECTEUR T	€ 16,50	
ID/01056374	● ALU	CONNECTEUR T	€ 16,50	
ID/01721780	● NOIR	ADAPTATEUR 1 PHASE +CROCHET	€ 12,00	
ID/01721781	○ BLANC	ADAPTATEUR 1 PHASE +CROCHET	€ 12,00	
ID/01721782	● ALU	ADAPTATEUR 1 PHASE +CROCHET	€ 12,00	
ID/01721776	● NOIR	ADAPTATEUR POUR SUSPENSION	€ 12,00	
ID/01056383	○ BLANC	ADAPTATEUR POUR SUSPENSION	€ 12,00	
ID/01056384	● ALU	ADAPTATEUR POUR SUSPENSION	€ 12,00	
ID/01721784	● NOIR	EMBOUT DE FINITION	€ 3,50	
ID/01056385	○ BLANC	EMBOUT DE FINITION	€ 3,50	
ID/01056386	● ALU	EMBOUT DE FINITION	€ 3,50	
ID/03222460	● ALU	CABLES DE SUSPENSION	€ 35,00	
ID/01721787	● NOIR	PATÈRE DE PLAFOND	€ 16,50	
ID/01252494	○ BLANC	PATÈRE DE PLAFOND	€ 16,50	
ID/01252495	● ALU	PATÈRE DE PLAFOND	€ 16,50	

TRACK LIGHTS 1 PHASE

PURI

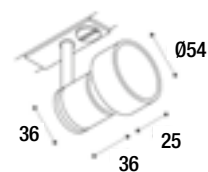

RÉF. ID	CULOT	PUISSANCE MAX	FLUX MAX	COULEUR	PRIX HTVA
ID/01721799	GU10	MAX 9W	575 LM	● NOIR	€ 30,00
ID/01056395	GU10	MAX 9W	575 LM	○ BLANC	€ 30,00
ID/01056396	GU10	MAX 9W	575 LM	● GRIS	€ 30,00

AVO

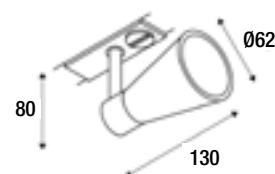

RÉF. ID	CULOT	PUISSANCE MAX	FLUX MAX	COULEUR	PRIX HTVA
ID/02271518	GU10	MAX 9W	575 LM	● NOIR	€ 33,00
ID/02271519	GU10	MAX 9W	575 LM	○ BLANC	€ 33,00
ID/02271520	GU10	MAX 9W	575 LM	● GRIS	€ 33,00

RAILS & TRACK LIGHT

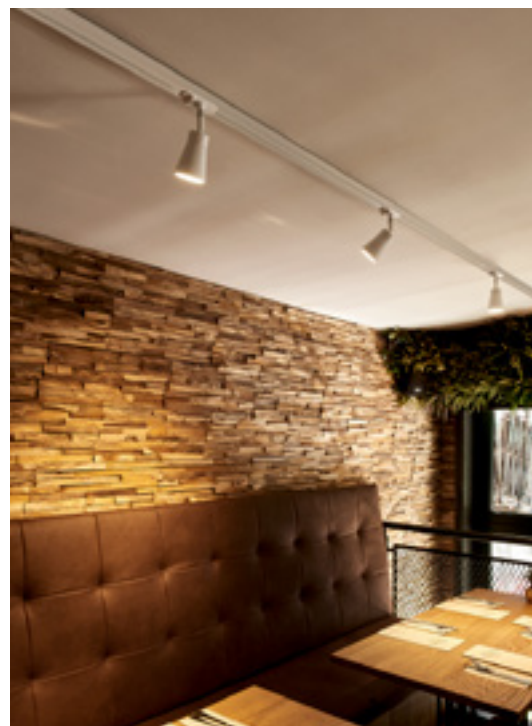

TRACK LIGHTS 1 PHASE

ENOLA-B

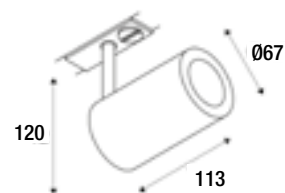

RÉF. ID	CULOT	PUISSANCE MAX	FLUX MAX	COULEUR	PRIX HTVA
ID/02748601	GU10	MAX 9W	575 LM	● NOIR	€ 67,00
ID/02748602	GU10	MAX 9W	575 LM	○ BLANC	€ 67,00
ID/02748603	GU10	MAX 9W	575 LM	● GRIS	€ 67,00
ID/01056746		ANNEAU DÉCO DE FINITION NOIR			€ 7,50

NOBLO

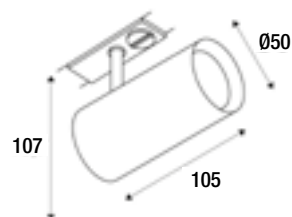

RÉF. ID	PUISSANCE	FLUX	T°	COULEUR	PRIX HTVA
ID/02748415	7,5W	620 LM	2700°K	● NOIR	€ 55,00
ID/02748416	7,5W	620 LM	2700°K	○ BLANC	€ 55,00
ID/02748417	7,5W	620 LM	2700°K	● GRIS	€ 55,00

HELIA

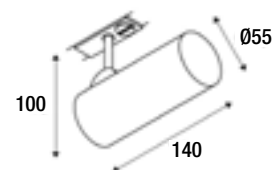

RÉF. ID	PUISSANCE	FLUX	T°	COULEUR	PRIX HTVA
ID/02551181	11W	750 LM	3000°K	● NOIR	€ 110,00
ID/02551182	11W	750 LM	3000°K	○ BLANC	€ 110,00

TRACK LIGHTS 1 PHASE

EURO

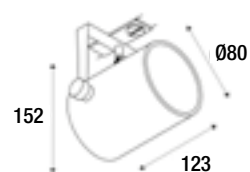

NEW

RÉF. ID	CULOT	PUISSANCE MAX	FLUX MAX	COULEUR	PRIX HTVA
ID/02748414	GU10	MAX 9W	575 LM	● NOIR	€ 65,00
ID/01252482	GU10	MAX 9W	575 LM	○ BLANC	€ 65,00

LIGHT EYE BALL

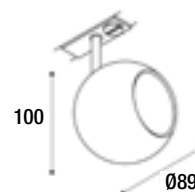

RÉF. ID	CULOT	PUISSANCE MAX	FLUX MAX	COULEUR	PRIX HTVA
ID/01910433	GU10	MAX 9W	575 LM	● NOIR	€ 70,00
ID/01910434	GU10	MAX 9W	575 LM	○ BLANC	€ 70,00
ID/01910435	GU10	MAX 9W	575 LM	● LAITON	€ 80,00
ID/01910437	GU10	MAX 9W	575 LM	● CUIVRE	€ 80,00

LIGHT EYE ACCESSOIRES



RÉF. ID	ACCESSOIRES EN OPTION	COULEUR	PRIX HTVA
ID/01722006	ANNEAU DÉCO	● NOIR	€ 4,40
ID/01722007	ANNEAU DÉCO	○ BLANC	€ 4,40
ID/01056688	ANNEAU DÉCO	● ARGENTÉ	€ 6,50

TRACK LIGHTS 1 PHASE

LIGHT EYE BALL SUSPENSION

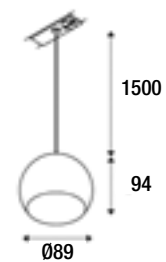
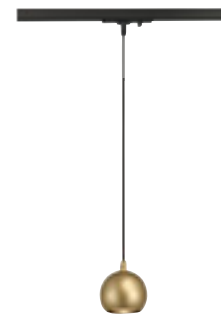

RÉF. ID	CULOT	PUISSANCE MAX	FLUX MAX	COULEUR	PRIX HTVA
ID/01910440	GU10	MAX 9W	575 LM	● LAITON	€ 80,00

RAILS & TRACK LIGHT

ENOLA SUSPENSION

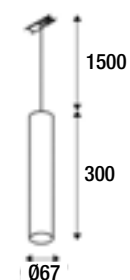

RÉF. ID	CULOT	PUISSANCE MAX	FLUX MAX	COULEUR	PRIX HTVA
ID/01910425	GU10	MAX 9W	575 LM	● NOIR	€ 120,00
ID/01721803	GU10	MAX 9W	575 LM	○ BLANC	€ 120,00
ID/01721804	GU10	MAX 9W	575 LM	● GRIS	€ 120,00
ID/01910426	GU10	MAX 9W	575 LM	● LAITON	€ 140,00

TRACK LIGHTS 1 PHASE

ODREY TRACK



230V



RAILS & TRACK LIGHT

NEW

RÉF. ID	CULOT	PUISSANCE MAX	FLUX MAX	COULEUR	MATÉRIAU	PRIX HTVA
ID/03361712	GU10	MAX 9W	575 LM	● NOIR	ALUMINIUM	€ 73,00
ID/03361713	GU10	MAX 9W	575 LM	● OR	ALUMINIUM	€ 73,00
ID/01721776		ADAPTATEUR NOIR POUR TRACK 1 PHASE (REQUIS)				€ 12,00
ID/01056383		ADAPTATEUR BLANC POUR TRACK 1 PHASE (REQUIS)				€ 12,00

Disponible en suspension page 160
Disponible en applique page 210

ODREY INNER COVER 1.0 (OPTIONNEL)

- Compatible avec les Odrey shade 6.0, 7.0 et 8.0



SHADE 8.0
+ INNER COVER

NEW

RÉF. ID	COULEUR	MATÉRIAU	PRIX HTVA
ID/03361714	● NOIR	ALUMINIUM	€ 26,00
ID/03361715	● OR	ALUMINIUM	€ 26,00

TRACK LIGHTS 1 PHASE

ODREY SHADE (REQUIS)



SHADE 1.0



SHADE 2.0



SHADE 3.0



SHADE 4.0



SHADE 5.0



SHADE 6.0



SHADE 7.0



SHADE 8.0

NEW

RÉF. ID	FORME	COULEUR	DIMENSIONS MM	MATÉRIAU	PRIX HTVA
ID/03361718	SHADE 1.0	● NOIR	Ø 55 X 50	ALUMINIUM	€ 31,00
ID/03361719	SHADE 1.0	● OR	Ø 55 X 50	ALUMINIUM	€ 31,00
ID/03598529	SHADE 2.0	● NOIR + INNER COVER ● NOIR	Ø 250 X 44	ALUMINIUM	€ 88,00
ID/03598528	SHADE 2.0	● NOIR + INNER COVER ● OR	Ø 250 X 44	ALUMINIUM	€ 88,00
ID/03598526	SHADE 2.0	● OR + INNER COVER ● OR	Ø 250 X 44	ALUMINIUM	€ 88,00
ID/03598527	SHADE 2.0	● OR + INNER COVER ● NOIR	Ø 250 X 44	ALUMINIUM	€ 88,00
ID/03361722	SHADE 3.0	● NOIR	Ø 100 X 85	ALUMINIUM	€ 27,00
ID/03361723	SHADE 3.0	● OR	Ø 100 X 85	ALUMINIUM	€ 27,00
ID/03361724	SHADE 4.0	● NOIR	Ø 124 X 120	ALUMINIUM	€ 37,00
ID/03361725	SHADE 4.0	● OR	Ø 124 X 120	ALUMINIUM	€ 37,00
ID/03361726	SHADE 5.0	● NOIR	Ø 115 X 160	ALUMINIUM	€ 49,00
ID/03361727	SHADE 5.0	● OR	Ø 115 X 160	ALUMINIUM	€ 49,00
ID/03361728	SHADE 6.0	● NOIR	Ø 190 X 75	ALUMINIUM	€ 39,00
ID/03361729	SHADE 6.0	● OR	Ø 190 X 75	ALUMINIUM	€ 39,00
ID/03361730	SHADE 7.0	● NOIR	Ø 150 X 50	ALUMINIUM	€ 41,00
ID/03361731	SHADE 7.0	● OR	Ø 150 X 50	ALUMINIUM	€ 41,00
ID/03361732	SHADE 8.0	● NOIR	Ø 250 X 50	ALUMINIUM	€ 63,00
ID/03361733	SHADE 8.0	● OR	Ø 250 X 50	ALUMINIUM	€ 63,00

RAILS 3 PHASES

RAILS TRIPHASÉS 230V

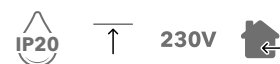

RÉF. ID	COULEUR	LONGUEUR	PRIX HTVA
ID/02199896	● NOIR	1 000 MM	€ 29,00
ID/02199897	○ BLANC	1 000 MM	€ 29,00
ID/02199899	● NOIR	2 000 MM	€ 58,00
ID/02199900	○ BLANC	2 000 MM	€ 58,00
ID/02199902	● NOIR	3 000 MM	€ 87,00
ID/02199903	○ BLANC	3 000 MM	€ 87,00

- Tension secteur 230/250V
Le raccordement au triphasé autorise une intensité totale de 16A sur chaque circuit, ce qui correspond à $3 \times 3680VA = 11040VA$.
-Un rail peut supporter une charge de 2kg/0.20m avec une distance max de 1.00m entre les points de fixation. Pour une charge de 5kg/0.20m, la distance doit être ramenée à 0.50m

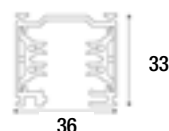

Le conseil de l'éclairagiste:





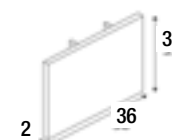
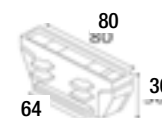
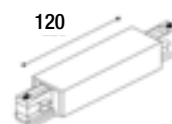
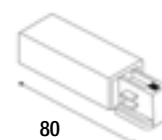

Le rail 3 phases s'adapte aussi bien aux espaces privés qu'aux magasins et autres espaces professionnels. Etant un standard international et pouvant recevoir une multitude de luminaires très variés provenant de centaines de marques différentes, le rail «tri» est également intéressant pour ses 3 circuits possibles d'allumage.

ACCESSOIRES POUR RAILS

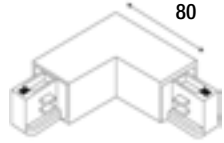
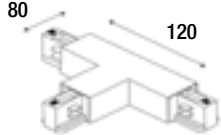
RÉF. ID	COULEUR	TYPE	PRIX HTVA
ID/02199970	● NOIR	ALIMENTATION DROITE	€ 12,00
ID/02199971	○ BLANC	ALIMENTATION DROITE	€ 12,00
ID/02199973	● NOIR	ALIMENTATION GAUCHE	€ 12,00
ID/02199974	○ BLANC	ALIMENTATION GAUCHE	€ 12,00
ID/02199976	● NOIR	ALIMENTATION CENTRALE	€ 24,00
ID/02199977	○ BLANC	ALIMENTATION CENTRALE	€ 24,00
ID/02199925	● NOIR	CONNEXION ELECTRIQUE	€ 8,00
ID/02199926	○ BLANC	CONNEXION ELECTRIQUE	€ 8,00
ID/02199999	● NOIR	EMBOUT DE FINITION	€ 1,20
ID/02200000	○ BLANC	EMBOUT DE FINITION	€ 1,20

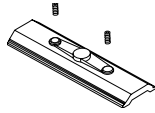

ACCESSOIRES POUR RAILS

RÉF. ID	COULEUR	TYPE	PRIX HTVA	
ID/02199981	● NOIR	CONNEXION L 90 INTERIEUR	€ 25,00	
ID/02199982	○ BLANC	CONNEXION L 90 INTERIEUR	€ 25,00	
ID/02199984	● NOIR	CONNEXION L 90 EXTERIEUR	€ 25,00	
ID/02199985	○ BLANC	CONNEXION L 90 EXTERIEUR	€ 25,00	
ID/02736925	● NOIR	CONNEXION ARTICULEE	€ 39,00	
ID/02736926	○ BLANC	CONNEXION ARTICULEE	€ 39,00	
ID/02199987	● NOIR	CONNEXION T DROITE	€ 37,00	
ID/02199988	○ BLANC	CONNEXION T DROITE	€ 37,00	
ID/02199990	● NOIR	CONNEXION T GAUCHE	€ 37,00	
ID/02199991	○ BLANC	CONNEXION T GAUCHE	€ 37,00	
ID/03546942	● NOIR	ADAPTATEUR POUR SUSPENSION 6A 10KG	€ 17,00	
ID/03546943	○ BLANC	ADAPTATEUR POUR SUSPENSION 6A 10KG	€ 17,00	
ID/02199941	● ALU	KIT FIXATION PLAFOND	€ 5,00	
ID/02199933	● NOIR	KIT DE SUSPENSION 60MM X 2000 MM	€ 5,00	
ID/02199934	○ BLANC	KIT DE SUSPENSION 60MM X 2000 MM	€ 5,00	
ID/02199936	● NOIR	KIT DE SUSPENSION 120MM X 2000 MM	€ 9,00	
ID/02199937	○ BLANC	KIT DE SUSPENSION 120MM X 2000 MM	€ 9,00	
ID/02199935	● ALU	PATTE DE FIXATION 120MM	€ 6,00	
ID/02199938	● NOIR	KIT DE SUSPENSION 2000 MM AVEC BLOCAGE AUTOMATIQUE	€ 12,00	
ID/02199939	○ BLANC	KIT DE SUSPENSION 2000 MM AVEC BLOCAGE AUTOMATIQUE	€ 12,00	
ID/03126219	● NOIR	BASE APPARENTE	€ 25,00	
ID/03126220	○ BLANC	BASE APPARENTE	€ 25,00	



TRACK LIGHTS 3 PHASES

JIMY 2

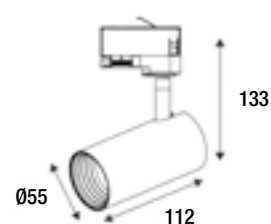

RÉF. ID	PUISSANCE	FLUX	T°	COULEUR	PRIX HTVA
ID/02682286	8W	800 LM	3000°K	● NOIR	€ 75,00
ID/02682288	8W	800 LM	3000°K	○ BLANC	€ 75,00
ID/02682287	8W	800 LM	3000°K	● ARGENT	€ 75,00
ID/02510186	8W	850 LM	4000°K	● NOIR	€ 75,00
ID/02510188	8W	850 LM	4000°K	○ BLANC	€ 75,00
ID/02510187	8W	850 LM	4000°K	● ARGENT	€ 75,00

HALO

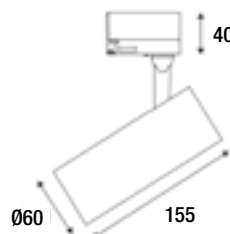

RÉF. ID	PUISSANCE	FLUX	T°	COULEUR	ANGLE	PRIX HTVA
ID/02682298	20W	2000 LM	3000°K	● NOIR	24°	€ 114,00
ID/02682299	20W	2000 LM	3000°K	○ BLANC	24°	€ 114,00
ID/02682296	20W	2100 LM	4000°K	● NOIR	24°	€ 114,00
ID/02682297	20W	2100 LM	4000°K	○ BLANC	24°	€ 114,00
ID/02682294	20W	2000 LM	3000°K	● NOIR	40°	€ 114,00
ID/02682295	20W	2000 LM	3000°K	○ BLANC	40°	€ 114,00
ID/02682292	20W	2100 LM	4000°K	● NOIR	40°	€ 114,00
ID/02682293	20W	2100 LM	4000°K	○ BLANC	40°	€ 114,00

TRACK LIGHTS 3 PHASES

YERA GU10

3 ANS

IP20



85°

TRIAC



A++
A

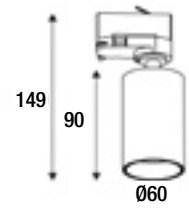

NEW

RÉF. ID	CULOT	PUISSANCE MAX	FLUX MAX	COULEUR	PRIX HTVA
ID/03382979	GU10	MAX 9W	575 LM	● NOIR MAT	€ 43,00
ID/03382980	GU10	MAX 9W	575 LM	○ BLANC MAT	€ 43,00



RAILS & TRACK LIGHT

TRACK LIGHTS 3 PHASES

GUN LED 28W

LED 5 ANS IP20 90° 42° IRC 80 A++ A

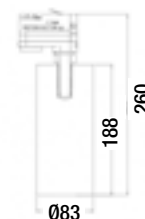

RAILS & TRACK LIGHT

RÉF. ID	PUISSANCE	FLUX	T°	COULEUR	PRIX HTVA
ID/02504685	28W	2429 LM	3000°K	● NOIR	€ 109,00
ID/02504686	28W	2429 LM	3000°K	○ BLANC	€ 109,00
ID/02233018	28W	2550 LM	4000°K	● NOIR	€ 109,00
ID/02233019	28W	2550 LM	4000°K	○ BLANC	€ 109,00

ACCESSOIRES GUN LED 28W

RÉF. ID	ACCESSOIRES	PRIX HTVA
ID/02233020	LENTILLE 15°	€ 12,00
ID/02233021	LENTILLE 24°	€ 12,00
ID/03546850	LENTILLE 60°	€ 12,00
ID/02736906	VOLETS NOIRS	€ 9,00
ID/02736907	VOLETS BLANCS	€ 9,00

TRACK LIGHTS 3 PHASES

GUN LED 42W

LED 5 ANS IP20 90° 42° IRC 80



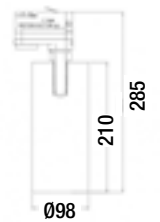

RAILS & TRACK LIGHT



RÉF. ID	PUISSANCE	FLUX	T°	COULEUR	PRIX HTVA
ID/02736904	42W	3700 LM	3000°K	● NOIR	€ 139,00
ID/02736905	42W	3700 LM	3000°K	○ BLANC	€ 139,00
ID/02736902	42W	3850 LM	4000°K	● NOIR	€ 139,00
ID/02736903	42W	3850 LM	4000°K	○ BLANC	€ 139,00

ACCESSOIRES GUN LED 42W

RÉF. ID	ACCESSOIRES	PRIX HTVA
ID/02736908	LENTILLE 15°	€ 16,50
ID/02736909	LENTILLE 24°	€ 16,50
ID/03546851	LENTILLE 60°	€ 16,50
ID/03128898	VOLETS NOIRS	€ 10,00
ID/03128899	VOLETS BLANCS	€ 10,00

TRACK LIGHTS 3 PHASES

DONDRA LED

LED 5 ANS IP20 90° 38° IRC >90 TRIAC ↑ A+ ↩



15W

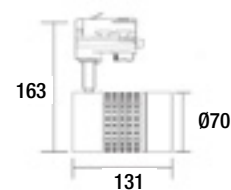

25W - 35 W

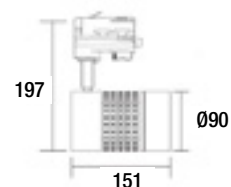

RAILS & TRACK LIGHT

RÉF. ID	PUISSANCE	FLUX	T°	COULEUR	PRIX HTVA
ID/01588199	15W	1200 LM	3000°K	● NOIR	€ 90,00
ID/01588200	15W	1200 LM	3000°K	○ BLANC	€ 90,00
ID/02116091	15W	1200 LM	4000°K	● NOIR	€ 90,00
ID/02116092	15W	1200 LM	4000°K	○ BLANC	€ 90,00
ID/01588201	25W	2000 LM	3000°K	● NOIR	€ 140,00
ID/01588202	25W	2000 LM	3000°K	○ BLANC	€ 140,00
ID/02116093	25W	2000 LM	4000°K	● NOIR	€ 140,00
ID/02116094	25W	2000 LM	4000°K	○ BLANC	€ 140,00
ID/01588205	35W	3000 LM	3000°K	● NOIR	€ 170,00
ID/01588206	35W	3000 LM	3000°K	○ BLANC	€ 170,00
ID/02116095	35W	3000 LM	4000°K	● NOIR	€ 170,00
ID/02116096	35W	3000 LM	4000°K	○ BLANC	€ 170,00



TRACK LIGHTS 3 PHASES

LIMA 25W

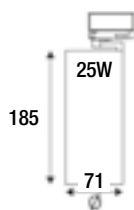

RÉF. ID	PUISSANCE	FLUX	T°	COULEUR	ANGLE	PRIX HTVA
ID/03126297	25W	2250 LM	3000°K	● NOIR	12°	€ 126,00
ID/03126298	25W	2250 LM	3000°K	○ BLANC	12°	€ 126,00
ID/03126295	25W	2350 LM	4000°K	● NOIR	12°	€ 126,00
ID/03126296	25W	2350 LM	4000°K	○ BLANC	12°	€ 126,00
ID/03126185	25W	2250 LM	3000°K	● NOIR	40°	€ 123,00
ID/03126186	25W	2250 LM	3000°K	○ BLANC	40°	€ 123,00
ID/03126183	25W	2350 LM	4000°K	● NOIR	40°	€ 123,00
ID/03126184	25W	2350 LM	4000°K	○ BLANC	40°	€ 123,00
ID/03126309	25W	2250 LM	3000°K	● NOIR	60°	€ 126,00
ID/03126310	25W	2250 LM	3000°K	○ BLANC	60°	€ 126,00
ID/03126307	25W	2350 LM	4000°K	● NOIR	60°	€ 126,00
ID/03126308	25W	2350 LM	4000°K	○ BLANC	60°	€ 126,00

ACCESSOIRES LIMA 25W

RÉF. ID	ACCESSOIRES	PRIX HTVA
ID/03126319	● GRILLE NID D'ABEILLE NOIRE POUR 25W	€ 5,00
ID/03126322	● FILTRE ALIMENTATION (VIANDE, FRUITS & LÉGUMES) POUR 25W	€ 21,00
ID/03126325	● FILTRE ALIMENTATION (BOULANGERIE) POUR 25W	€ 21,00
ID/03126328	● FILTRE LAME DE LUMIERE POUR 25W	€ 4,00

TRACK LIGHTS 3 PHASES

LIMA 35W

LED 5 ANS IP20 90° IRC >90

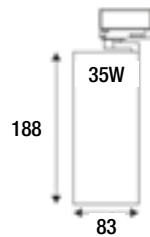

RÉF. ID	PUISSANCE	FLUX	T°	COULEUR	ANGLE	PRIX HTVA
ID/03126301	35W	3000 LM	3000°K	● NOIR	12°	€ 141,00
ID/03126302	35W	3000 LM	3000°K	○ BLANC	12°	€ 141,00
ID/03126299	35W	3100 LM	4000°K	● NOIR	12°	€ 141,00
ID/03126300	35W	3100 LM	4000°K	○ BLANC	12°	€ 141,00
ID/03126191	35W	3000 LM	3000°K	● NOIR	40°	€ 138,00
ID/03126192	35W	3000 LM	3000°K	○ BLANC	40°	€ 138,00
ID/03126189	35W	3100 LM	4000°K	● NOIR	40°	€ 138,00
ID/03126190	35W	3100 LM	4000°K	○ BLANC	40°	€ 138,00
ID/03126313	35W	3000 LM	3000°K	● NOIR	60°	€ 141,00
ID/03126314	35W	3000 LM	3000°K	○ BLANC	60°	€ 141,00
ID/03126311	35W	3100 LM	4000°K	● NOIR	60°	€ 141,00
ID/03126312	35W	3100 LM	4000°K	○ BLANC	60°	€ 141,00

ACCESSOIRES LIMA 35W

RÉF. ID	ACCESSOIRES	PRIX HTVA
ID/03126320	● GRILLE NID D'ABEILLE NOIRE POUR 35W	€ 6,00
ID/03126323	● FILTRE ALIMENTATION (VIANDE, FRUITS & LÉGUMES) POUR 35W	€ 22,00
ID/03126326	● FILTRE ALIMENTATION (BOULANGERIE) POUR 35W	€ 22,00
ID/03126329	● FILTRE LAME DE LUMIERE POUR 35W	€ 4,00

TRACK LIGHTS 3 PHASES

LIMA 50W

LED 5 ANS IP20 90° IRC >90

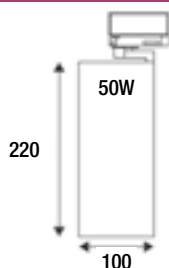

RÉF. ID	PUISSANCE	FLUX	T°	COULEUR	ANGLE	PRIX HTVA
ID/03126305	50W	4800 LM	3000°K	● NOIR	12°	€ 177,00
ID/03126306	50W	4800 LM	3000°K	○ BLANC	12°	€ 177,00
ID/03126303	50W	5000 LM	4000°K	● NOIR	12°	€ 177,00
ID/03126304	50W	5000 LM	4000°K	○ BLANC	12°	€ 177,00
ID/03126197	50W	4800 LM	3000°K	● NOIR	40°	€ 174,00
ID/03126198	50W	4800 LM	3000°K	○ BLANC	40°	€ 174,00
ID/03126195	50W	5000 LM	4000°K	● NOIR	40°	€ 174,00
ID/03126196	50W	5000 LM	4000°K	○ BLANC	40°	€ 174,00
ID/03126317	50W	4800 LM	3000°K	● NOIR	60°	€ 177,00
ID/03126318	50W	4800 LM	3000°K	○ BLANC	60°	€ 177,00
ID/03126315	50W	5000 LM	4000°K	● NOIR	60°	€ 177,00
ID/03126316	50W	5000 LM	4000°K	○ BLANC	60°	€ 177,00

ACCESSOIRES LIMA 50W

RÉF. ID	ACCESSOIRES	PRIX HTVA
ID/03126321	 GRILLE NID D'ABEILLE NOIRE POUR 50W	€ 7,00
ID/03126324	 FILTRE ALIMENTATION (VIANDE, FRUITS & LÉGUMES) POUR 50W	€ 25,00
ID/03126327	 FILTRE ALIMENTATION (BOULANGERIE) POUR 50W	€ 25,00
ID/03126330	 FILTRE LAME DE LUMIERE POUR 50W	€ 5,00



RAILS & TRACK LIGHT

TRACK LIGHTS 3 PHASES

OSIS 1



NEW

RÉF. ID	PUISSANCE	FLUX	T°	COULEUR	PRIX HTVA
ID/03382999	25W	1783 LM	3000°K	● NOIR MAT	€ 89,00
ID/03383000	25W	2002 LM	3000°K	○ BLANC MAT	€ 89,00
ID/03382997	25W	1791 LM	4000°K	● NOIR MAT	€ 89,00
ID/03382998	25W	2086 LM	4000°K	○ BLANC MAT	€ 89,00

OSIS 2



NEW

RÉF. ID	PUISSANCE	FLUX	T°	COULEUR	PRIX HTVA
ID/03383003	40W	2360 LM	3000°K	● NOIR MAT	€ 112,00
ID/03383004	40W	2985 LM	3000°K	○ BLANC MAT	€ 112,00
ID/03383001	40W	2840 LM	4000°K	● NOIR MAT	€ 112,00
ID/03383002	40W	3617 LM	4000°K	○ BLANC MAT	€ 112,00

TRACK LIGHTS 3 PHASES

FLASH

LED 3 ANS IP20 90° 50° IRC >80

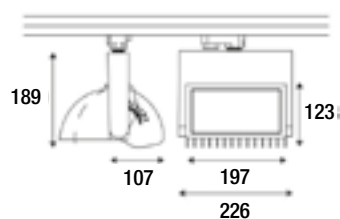

RÉF. ID	PUISSANCE	FLUX	T°	COULEUR	PRIX HTVA
ID/02510174	40W	3754 LM	3000°K	● NOIR	€ 220,00
ID/02510175	40W	3754 LM	3000°K	○ BLANC	€ 220,00
ID/02510172	40W	4306 LM	4000°K	● NOIR	€ 220,00
ID/02510173	40W	4306 LM	4000°K	○ BLANC	€ 220,00



RAILS & TRACK LIGHT

TRACK LIGHTS 3 PHASES

ARTELINE

LED 5 ANS IP20 180° IRC >80



- Structure linéaire pour éclairage diffus
- Idéal en complément de spots

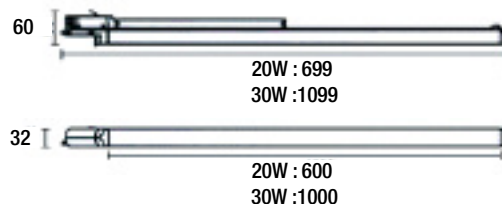

RÉF. ID	PUISSANCE	FLUX	T°	COULEUR	LONGUEUR MM	PRIX HTVA
ID/02539712	20W	1489 LM	3000°K	● NOIR	699	€ 135,00
ID/02539713	20W	1489 LM	3000°K	○ BLANC	699	€ 135,00
ID/02504687	20W	1539 LM	4000°K	● NOIR	699	€ 135,00
ID/02504688	20W	1539 LM	4000°K	○ BLANC	699	€ 135,00
ID/02539714	30W	2345 LM	3000°K	● NOIR	1099	€ 169,00
ID/02539715	30W	2345 LM	3000°K	○ BLANC	1099	€ 169,00
ID/02504689	30W	2387 LM	4000°K	● NOIR	1099	€ 169,00
ID/02504690	30W	2387 LM	4000°K	○ BLANC	1099	€ 169,00

TRACKLINE 55

LED IP20 120° IRC >90



- Structure linéaire pour éclairage diffus
- Optique anti éblouissement

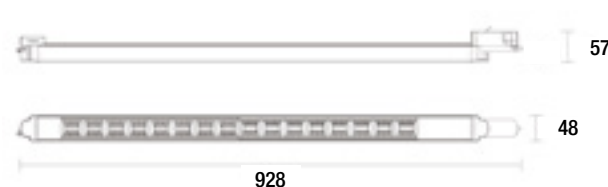

RÉF. ID	PUISSANCE	FLUX	T°	UGR	COULEUR	LONGUEUR MM	PRIX HTVA
ID/02775559	55W	4800 LM	2700°K	< 19	● NOIR	928	€ 250,00
ID/02775556	55W	5300 LM	3000°K	< 19	○ BLANC	928	€ 250,00
ID/02775560	55W	5300 LM	3000°K	< 19	● NOIR	928	€ 250,00
ID/02775558	55W	5500 LM	4000°K	< 19	○ BLANC	928	€ 250,00
ID/02775561	55W	5500 LM	4000°K	< 19	● NOIR	928	€ 250,00

TRACK LIGHTS 3 PHASES

LINEA 1

LED 3 ANS IP20 90° 120° IRC 80

- Structure linéaire pour éclairage diffus
- Orientable



NEW

RÉF. ID	PUISSANCE	FLUX	T°	COULEUR	PRIX HTVA
ID/03286995	30W	3750 LM	3000°K	● NOIR	€ 198,00
ID/03286996	30W	3750 LM	3000°K	○ BLANC	€ 198,00
ID/03286993	30W	3900 LM	4000°K	● NOIR	€ 198,00
ID/03286994	30W	3900 LM	4000°K	○ BLANC	€ 198,00

LINEA 2

LED 3 ANS IP20 90° 120° IRC 80

- Structure linéaire double pour éclairage diffus
- Orientable

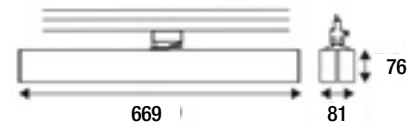

NEW

RÉF. ID	PUISSANCE	FLUX	T°	COULEUR	PRIX HTVA
ID/03382977	2 X 30W	2 X 3750 LM	3000°K	● NOIR	€ 299,00
ID/03382978	2 X 30W	2 X 3750 LM	3000°K	○ BLANC	€ 299,00
ID/03382975	2 X 30W	2 X 3900 LM	4000°K	● NOIR	€ 299,00
ID/03382976	2 X 30W	2 X 3900 LM	4000°K	○ BLANC	€ 299,00

PROFILES RAILS 48Vdc

RAILS APPARENTS 48V

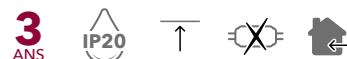

RÉF. ID	AC/DC	COULEUR	LONGUEUR MM	PRIX HTVA
ID/03126215	DC 48V MAX 9,5A	● NOIR MAT	1 000	€ 55,00
ID/03126218	DC 48V MAX 9,5A	● NOIR MAT	2 000	€ 110,00
ID/03126221	DC 48V MAX 9,5A	● NOIR MAT	3 000	€ 165,00

- Rail apparent 48Vdc
- Alimentation à commander séparément
- L'alimentation peut être déportée ou incluse dans le rail en utilisant le boîtier prévu à cet effet

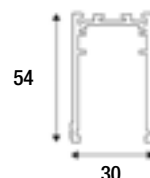

ACCESSOIRES POUR RAILS 48V

RÉF. ID	COULEUR	TYPE	PRIX HTVA
ID/03126222	● NOIR	CONNEXION L 90° PLAFOND	€ 11,50
ID/03126223	● NOIR	CONNEXION L 90° MUR INT	€ 11,50
ID/03126224	● NOIR	CONNEXION L 90° MUR EXT	€ 11,50
ID/03126225	● NOIR	ALIMENTATION+CABLE 15CM	€ 30,00
ID/03126226	● NOIR	CONNEXION ELECTRIQUE	€ 11,00
ID/03126227	● NOIR	CONNEXION MECANIQUE	€ 6,50
ID/03126228	● NOIR	CONNEXION ELECTRIQUE AVEC CABLE	€ 29,00
ID/03126229	● NOIR	BOITIER POUR DRIVER 100W	€ 66,00
ID/03126230	● NOIR	FILIN DE SUSPENSION 150CM	€ 11,50
ID/03126231	● NOIR	MOULURE DE FINITION 100CM	€ 6,50

PROFILES RAILS 48Vdc









RÉF. ID	COULEUR	TYPE	PRIX HTVA	
ID/03126232	● NOIR	MOULURE DE FINITION 200CM	€ 8,00	
ID/03126233	● NOIR	MOULURE DE FINITION 300CM	€ 10,00	
ID/03126234	● NOIR	EMBOUT DE FINITION	€ 4,50	
ID/03126156		DRIVER NON DIMMABLE 100W 48V	€ 125,00	
ID/03126157		DRIVER NON DIMMABLE 200W 48V	€ 145,00	
ID/03126158		DRIVER NON DIMMABLE 450W 48V	€ 315,00	
ID/03382777		DRIVER DIMMABLE DALI 75W 48V	€ 322,00	
ID/03382778		DRIVER DIMMABLE DALI 150W 48V	€ 386,00	

SCHÉMA D'INSTALLATION



PROFILES RAILS 48Vdc

RAILS ENCASTRÉS 48V

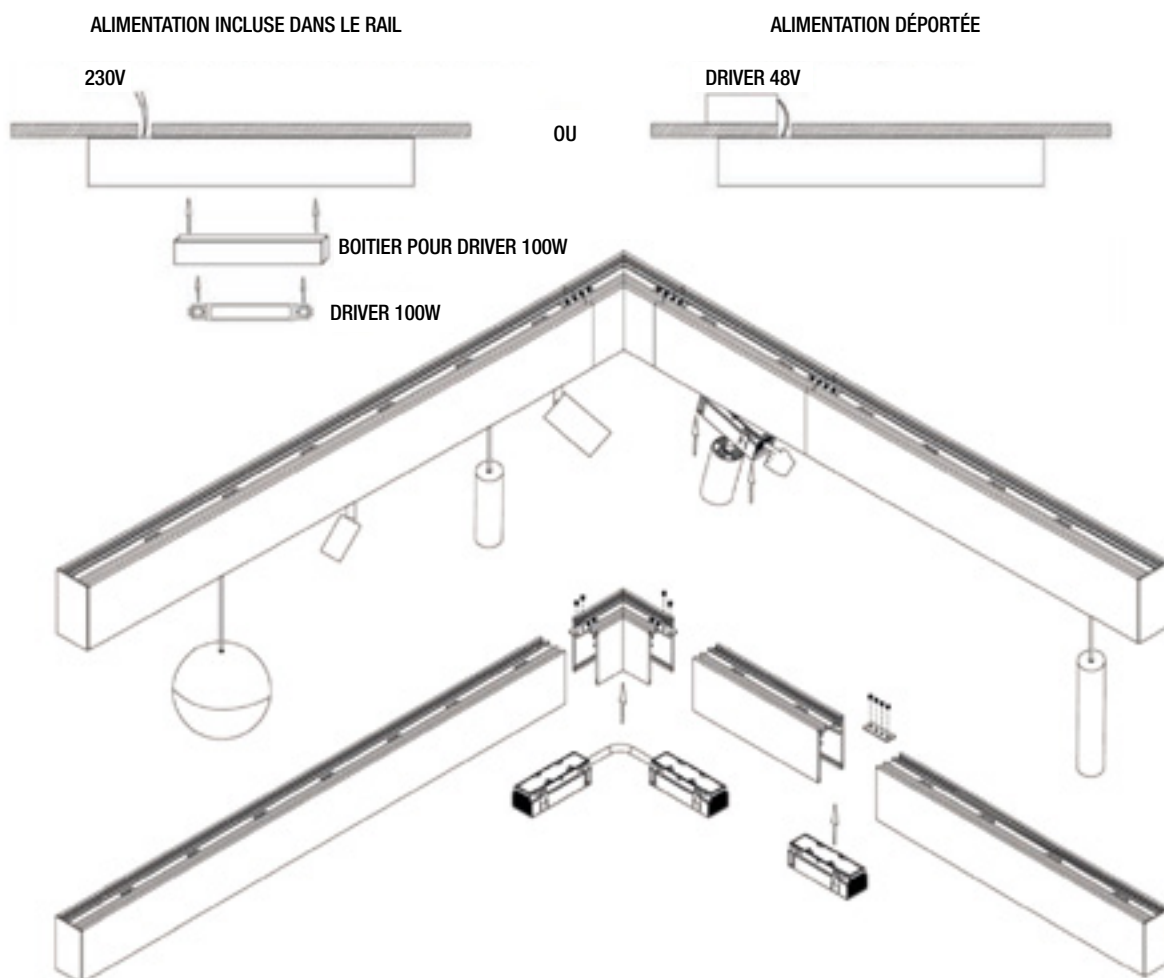
3
ANS

IP20



RÉF. ID	AC/DC	COULEUR	LONGUEUR MM	PRIX HTVA
ID/03126235	DC 48V MAX 9,5A	● NOIR MAT	1 000	€ 65,00
ID/03126236	DC 48V MAX 9,5A	● NOIR MAT	2 000	€ 130,00
ID/03126237	DC 48V MAX 9,5A	● NOIR MAT	3 000	€ 195,00

- Rail encastré 48Vdc
- Alimentation à commander séparément
- Enduit de finition à réaliser

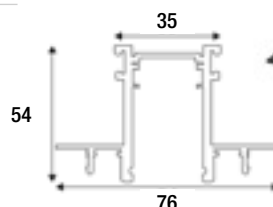

ACCESSOIRES POUR RAILS 48V

RÉF. ID	COULEUR	TYPE	PRIX HTVA
ID/03126238	● NOIR	CONNEXION L 90° PLAFOND POUR RAIL ENCASTRÉ	€ 13,00
ID/03126239	● NOIR	CONNEXION L 90° MUR INT POUR RAIL ENCASTRÉ	€ 13,00
ID/03126240	● NOIR	CONNEXION L 90° MUR EXT POUR RAIL ENCASTRÉ	€ 13,00
ID/03126225	● NOIR	ALIMENTATION+CABLE 15CM	€ 30,00
ID/03126226	● NOIR	CONNEXION ELECTRIQUE	€ 11,00
ID/03126227	● NOIR	CONNEXION MECANIQUE	€ 6,50
ID/03126228	● NOIR	CONNEXION ELECTRIQUE AVEC CABLE	€ 29,00
ID/03126229	● NOIR	BOITIER POUR DRIVER 100W	€ 66,00
ID/03126231	● NOIR	MOULURE DE FINITION 100CM	€ 6,50
ID/03126232	● NOIR	MOULURE DE FINITION 200CM	€ 8,00







RÉF. ID	COULEUR	TYPE	PRIX HTVA	
ID/03126233	● NOIR	MOULURE DE FINITION 300CM	€ 10,00	
ID/03126234	● NOIR	EMBOUIT DE FINITION	€ 4,50	
ID/03126156		DRIVER NON DIMMABLE 100W 48V	€ 125,00	
ID/03126157		DRIVER NON DIMMABLE 200W 48V	€ 145,00	
ID/03126158		DRIVER NON DIMMABLE 450W 48V	€ 315,00	
ID/03382777		DRIVER DIMMABLE DALI 75W 48V	€ 322,00	
ID/03382778		DRIVER DIMMABLE DALI 150W 48V	€ 386,00	

SCHÉMA D'INSTALLATION



TRACK LIGHTS 48Vdc

PARO 1

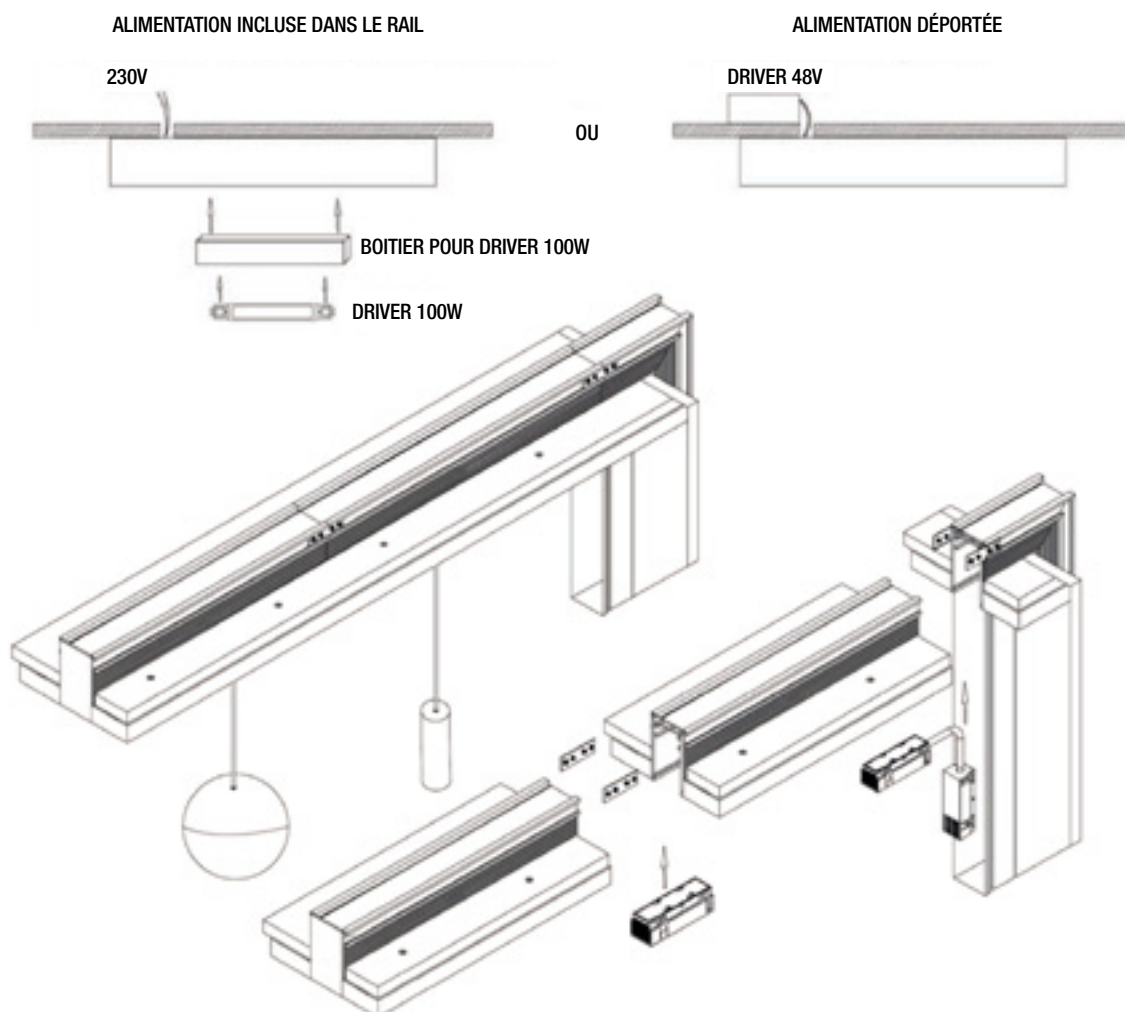
LED 3 ANS IP20 85° IRC >80 ↑ A+ ↩

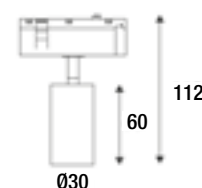

RAILS & TRACK LIGHT

RÉF. ID	PUISSANCE	FLUX	T°	COULEUR	ANGLE	DIMMABLE	PRIX HTVA
ID/03126264	8W	660 LM	3000°K	● NOIR MAT	24°	NON	€ 45,00
ID/03126263	8W	690 LM	4000°K	● NOIR MAT	24°	NON	€ 45,00
ID/03126262	8W	660 LM	3000°K	● NOIR MAT	36°	NON	€ 59,00
ID/03126261	8W	690 LM	4000°K	● NOIR MAT	36°	NON	€ 59,00
ID/03126260	8W	660 LM	3000°K	● NOIR MAT	50°	NON	€ 45,00
ID/03126259	8W	690 LM	4000°K	● NOIR MAT	50°	NON	€ 45,00
ID/03382956	8W	660 LM	3000°K	● NOIR MAT	24°	DALI	€ 140,00
ID/03382955	8W	690 LM	4000°K	● NOIR MAT	24°	DALI	€ 140,00
ID/03382954	8W	660 LM	3000°K	● NOIR MAT	36°	DALI	€ 140,00
ID/03382953	8W	690 LM	4000°K	● NOIR MAT	36°	DALI	€ 140,00
ID/03382952	8W	660 LM	3000°K	● NOIR MAT	50°	DALI	€ 140,00
ID/03382951	8W	690 LM	4000°K	● NOIR MAT	50°	DALI	€ 140,00

PARO 2

LED 3 ANS IP20 90° IRC >80 A+ 

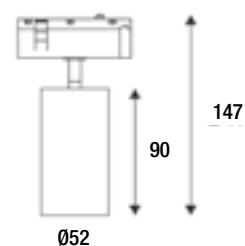

RÉF. ID	PUISSANCE	FLUX	T°	COULEUR	ANGLE	DIMMABLE	PRIX HTVA
ID/03126270	14W	1380 LM	3000°K	● NOIR MAT	15°	NON	€ 70,00
ID/03126269	14W	1500 LM	4000°K	● NOIR MAT	15°	NON	€ 70,00
ID/03126268	14W	1380 LM	3000°K	● NOIR MAT	30°	NON	€ 90,00
ID/03126267	14W	1500 LM	4000°K	● NOIR MAT	30°	NON	€ 90,00
ID/03126266	14W	1380 LM	3000°K	● NOIR MAT	50°	NON	€ 70,00
ID/03126265	14W	1500 LM	4000°K	● NOIR MAT	50°	NON	€ 70,00
ID/03382962	14W	1380 LM	3000°K	● NOIR MAT	15°	DALI	€ 170,00
ID/03382961	14W	1500 LM	4000°K	● NOIR MAT	15°	DALI	€ 170,00
ID/03382960	14W	1380 LM	3000°K	● NOIR MAT	30°	DALI	€ 170,00
ID/03382959	14W	1500 LM	4000°K	● NOIR MAT	30°	DALI	€ 170,00
ID/03382958	14W	1380 LM	3000°K	● NOIR MAT	50°	DALI	€ 170,00
ID/03382957	14W	1500 LM	4000°K	● NOIR MAT	50°	DALI	€ 170,00

TRACK LIGHTS 48Vdc

PARO 3

LED 3 ANS IP20 90° IRC >80 A+ 

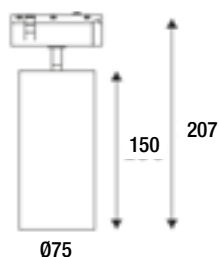

RÉF. ID	PUISSANCE	FLUX	T°	COULEUR	ANGLE	DIMMABLE	PRIX HTVA
ID/03126280	35W	2840 LM	3000°K	● NOIR MAT	30°	NON	€ 150,00
ID/03126279	35W	3100 LM	4000°K	● NOIR MAT	30°	NON	€ 150,00
ID/03126278	35W	2930 LM	3000°K	● NOIR MAT	50°	NON	€ 120,00
ID/03126277	35W	3215 LM	4000°K	● NOIR MAT	50°	NON	€ 120,00
ID/03382965	25W	2523 LM	3000°K	● NOIR MAT	30°	DALI	€ 220,00
ID/03382966	25W	2871 LM	4000°K	● NOIR MAT	30°	DALI	€ 220,00
ID/03382964	25W	2542 LM	3000°K	● NOIR MAT	50°	DALI	€ 220,00
ID/03382963	25W	2925 LM	4000°K	● NOIR MAT	50°	DALI	€ 220,00

RAILS & TRACK LIGHT

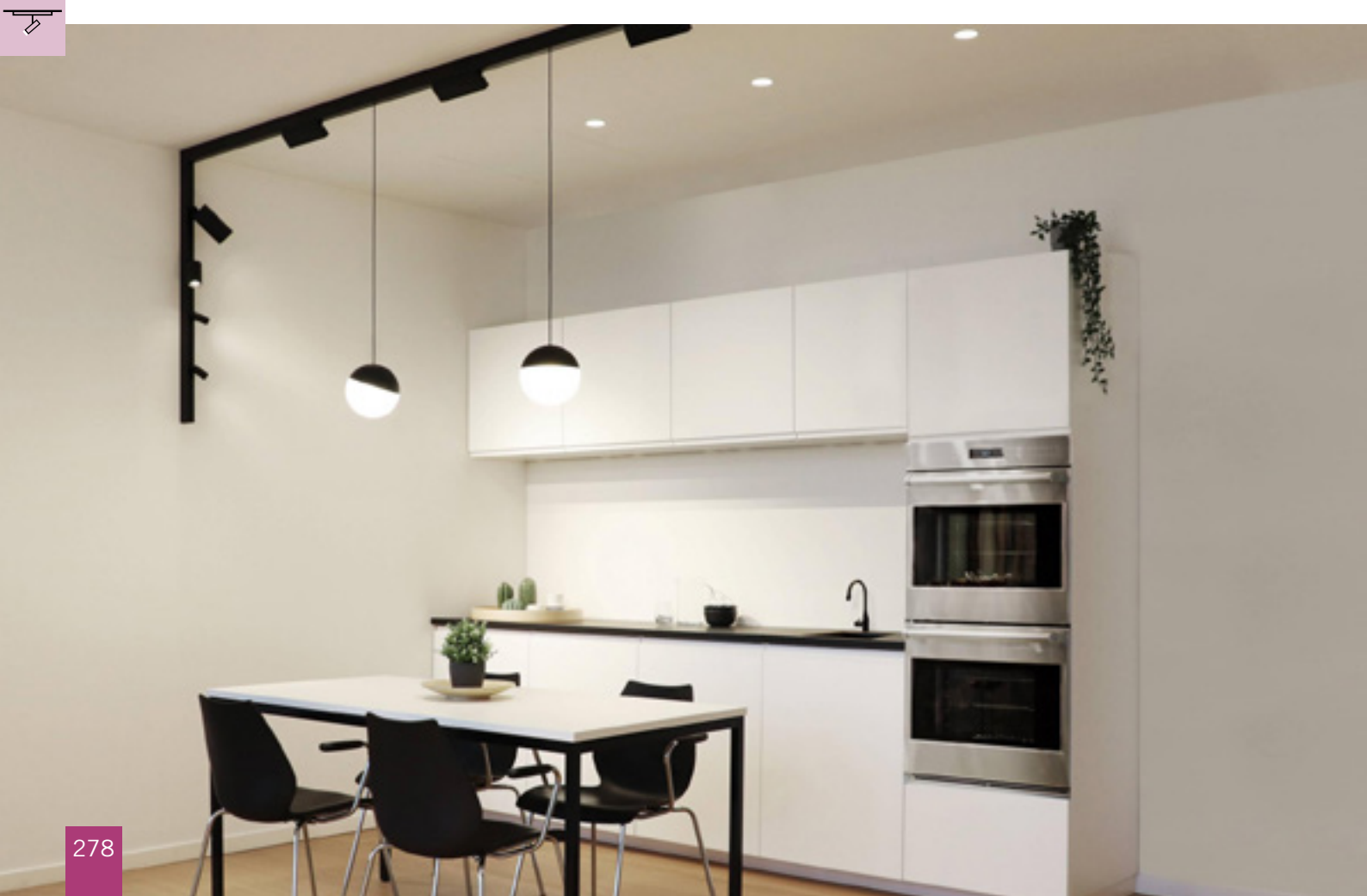

ACCESSOIRES PARO



1.



2.



3.



4.



5.



6.

	RÉF. ID	ACCESSOIRES	PRIX HTVA
1.	ID/03126271	BAGUE NOIRE POUR PARO 2	€ 13,00
1.	ID/03126281	BAGUE NOIRE POUR PARO 3	€ 24,00
2.	ID/03126272	WALL WASHER NOIR POUR PARO 2	€ 20,00
2.	ID/03126282	WALL WASHER NOIR POUR PARO 3	€ 33,00
3.	ID/03126273	BAGUE OPALINE POUR PARO 2	€ 6,50
3.	ID/03126283	BAGUE OPALINE POUR PARO 3	€ 9,00
4.	ID/03126274	DIFFUSEUR OPALIN POUR PARO 2	€ 2,50
4.	ID/03126284	DIFFUSEUR OPALIN POUR PARO 3	€ 3,50
5.	ID/03126275	FILTRE LAME DE LUMIERE POUR PARO 2	€ 2,50
5.	ID/03126285	FILTRE LAME DE LUMIERE POUR PARO 3	€ 3,50
6.	ID/03126276	GRILLE NID D'ABEILLE NOIRE POUR PARO 2	€ 2,50
6.	ID/03126286	GRILLE NID D'ABEILLE NOIRE POUR PARO 3	€ 5,50

Le conseil de l'éclairagiste:

Un éclairage technique peut, parfois, être affiné par des accessoires qui vont mettre en valeur la chose éclairée de manière encore plus optimale. Choisissez le bon accessoire en fonction de l'effet recherché...

- Bague noire: Esthétique et réduction de l'éblouissement.
- Wall-washer: Accentuation de l'homogénéité de la lumière sur une surface murale.
- Bague opaline: Eclairage adouci et plus diffus.
- Diffuseur opalin: Diminue l'effet «spot», éclairage plus diffus.
- Filtre lame de lumière: Concentre le faisceau en un effet de lame de lumière.
- Grille nid d'abeille: Diminue l'agressivité de la source et réduit l'éblouissement.



TRACK LIGHTS 48Vdc

BOO 1 T

LED 3 ANS IP20 45° IRC 80   A++ A 



Ø100

NEW

RÉF. ID	PUISSANCE	FLUX	T°	COULEUR	PRIX HTVA
ID/03382990	14W	920 LM	3000°K	● NOIR MAT	€ 154,00
ID/03382989	14W	935 LM	4000°K	● NOIR MAT	€ 154,00

RAILS & TRACK LIGHT



TRACK LIGHTS 48Vdc

KARO 1

LED 3 ANS IP20 30° IRC 80    

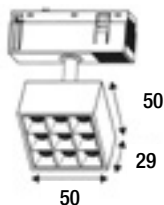

NEW

RÉF. ID	PUISSANCE	FLUX	T°	COULEUR	PRIX HTVA
ID/03382984	10W	523 LM	3000°K	● NOIR MAT	€ 69,00
ID/03382983	10W	530 LM	4000°K	● NOIR MAT	€ 69,00

KARO 2

LED 3 ANS IP20 30° IRC 80    

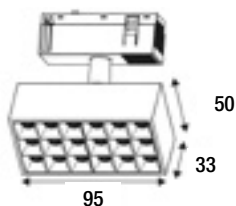

NEW

RÉF. ID	PUISSANCE	FLUX	T°	COULEUR	PRIX HTVA
ID/03382986	15W	1138 LM	3000°K	● NOIR MAT	€ 92,00
ID/03382985	15W	1146 LM	4000°K	● NOIR MAT	€ 92,00

KARO 3

LED 3 ANS IP20 30° IRC 80    

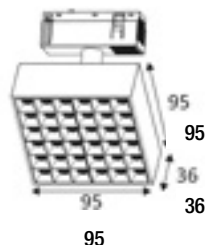
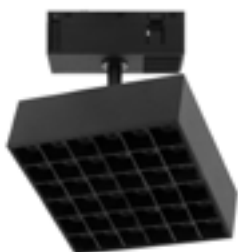

NEW

RÉF. ID	PUISSANCE	FLUX	T°	COULEUR	PRIX HTVA
ID/03382988	25W	2114 LM	3000°K	● NOIR MAT	€ 114,00
ID/03382987	25W	2221 LM	4000°K	● NOIR MAT	€ 114,00

TRACK LIGHTS 48Vdc

BERN

LED 3 ANS IP20 IRC >80 ↑ A+ ↩

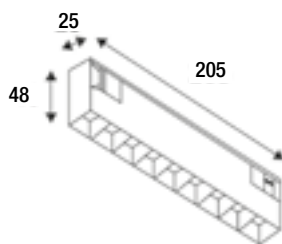

- Eclairage d'accentuation fixe

RÉF. ID	PUISSANCE	FLUX	T°	COULEUR	ANGLE	DIMMABLE	PRIX HTVA
ID/03126256	12W	832 LM	3000°K	● NOIR MAT	12°	NON	€ 120,00
ID/03126255	12W	878 LM	4000°K	● NOIR MAT	12°	NON	€ 120,00
ID/03126254	12W	865 LM	3000°K	● NOIR MAT	24°	NON	€ 120,00
ID/03126253	12W	941 LM	4000°K	● NOIR MAT	24°	NON	€ 120,00
ID/03126252	12W	849 LM	3000°K	● NOIR MAT	36°	NON	€ 120,00
ID/03126251	12W	939 LM	4000°K	● NOIR MAT	36°	NON	€ 120,00
ID/03382948	12W	832 LM	3000°K	● NOIR MAT	12°	DALI	€ 190,00
ID/03382947	12W	878 LM	4000°K	● NOIR MAT	12°	DALI	€ 190,00
ID/03382946	12W	865 LM	3000°K	● NOIR MAT	24°	DALI	€ 190,00
ID/03382945	12W	941 LM	4000°K	● NOIR MAT	24°	DALI	€ 190,00
ID/03382944	12W	849 LM	3000°K	● NOIR MAT	36°	DALI	€ 190,00
ID/03382943	12W	939 LM	4000°K	● NOIR MAT	36°	DALI	€ 190,00

ONEX

LED 3 ANS IP20 IRC >80 ↑ A+ ↩



ASYMÉTRIQUE

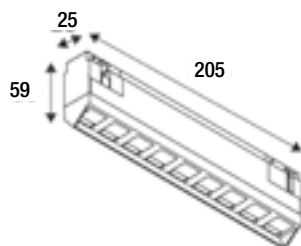

- Eclairage asymétrique (wall washer)
- Idéal pour éclairer murs, placards, bibliothèques...

RÉF. ID	PUISSANCE	FLUX	T°	COULEUR	DIMMABLE	PRIX HTVA
ID/03126258	12W	526 LM	3000°K	● NOIR MAT	NON	€ 130,00
ID/03126257	12W	594 LM	4000°K	● NOIR MAT	NON	€ 130,00
ID/03382950	12W	526 LM	3000°K	● NOIR MAT	DALI	€ 200,00
ID/03382949	12W	594 LM	4000°K	● NOIR MAT	DALI	€ 200,00



TRACK LIGHTS 48Vdc

VIGO

LED 3 ANS IP20 90° IRC >80 ↑ A+ ↩

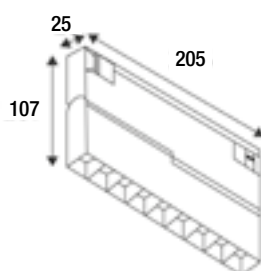

- Eclairage d'accentuation orientable

RÉF. ID	PUISSANCE	FLUX	T°	COULEUR	ANGLE	DIMMABLE	PRIX HTVA
ID/03126250	12W	888 LM	3000°K	● NOIR MAT	12°	NON	€ 175,00
ID/03126249	12W	1015 LM	4000°K	● NOIR MAT	12°	NON	€ 175,00
ID/03126248	12W	915 LM	3000°K	● NOIR MAT	24°	NON	€ 175,00
ID/03126247	12W	995 LM	4000°K	● NOIR MAT	24°	NON	€ 175,00
ID/03126246	12W	939 LM	3000°K	● NOIR MAT	36°	NON	€ 175,00
ID/03126245	12W	984 LM	4000°K	● NOIR MAT	36°	NON	€ 175,00
ID/03382942	12W	888 LM	3000°K	● NOIR MAT	12°	DALI	€ 230,00
ID/03382941	12W	1015 LM	4000°K	● NOIR MAT	12°	DALI	€ 230,00
ID/03382940	12W	915 LM	3000°K	● NOIR MAT	24°	DALI	€ 230,00
ID/03382939	12W	995 LM	4000°K	● NOIR MAT	24°	DALI	€ 230,00
ID/03382938	12W	939 LM	3000°K	● NOIR MAT	36°	DALI	€ 230,00
ID/03382937	12W	984 LM	4000°K	● NOIR MAT	36°	DALI	€ 230,00

RAILS & TRACK LIGHT

TRACK LIGHTS 48Vdc

CADIX

LED 3 ANS IP20 110° IRC >80 ↑ A+ ↩

- Structure linéaire pour éclairage diffus

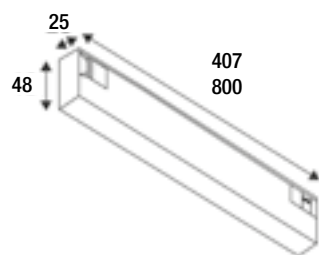

RAILS & TRACK LIGHT

RÉF. ID	PUISSANCE	FLUX	T°	COULEUR	DIMMABLE	PRIX HTVA
ID/03126242	11W	783 LM	3000°K	● NOIR MAT	NON	€ 90,00
ID/03126241	11W	992 LM	4000°K	● NOIR MAT	NON	€ 90,00
ID/03126244	18W	1470 LM	3000°K	● NOIR MAT	NON	€ 160,00
ID/03126243	18W	1485 LM	4000°K	● NOIR MAT	NON	€ 160,00
ID/03382934	11W	783 LM	3000°K	● NOIR MAT	DALI	€ 170,00
ID/03382933	11W	992 LM	4000°K	● NOIR MAT	DALI	€ 170,00
ID/03382936	18W	1470 LM	3000°K	● NOIR MAT	DALI	€ 220,00
ID/03382935	18W	1485 LM	4000°K	● NOIR MAT	DALI	€ 220,00

TRACK LIGHTS 48Vdc

LEGA

LED 3 ANS IP20 110° IRC 80 DALI ↑ A++ A ↩

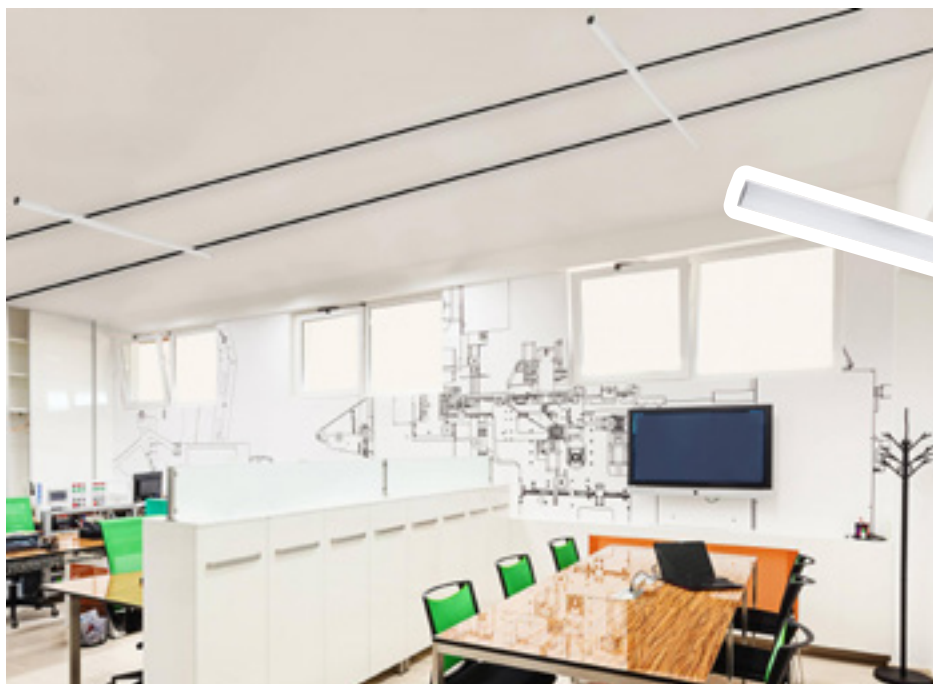

NEW

RÉF. ID	PUISSANCE	FLUX	T°	COULEUR	PRIX HTVA
ID/03382992	21W	1737 LM	3000°K	● NOIR MAT	€ 267,00
ID/03382991	21W	1814 LM	4000°K	● NOIR MAT	€ 267,00



TRACK LIGHTS 48Vdc

IRO 1

LED 3 ANS IP20 50° IRC >80 ↑ A+ ↩

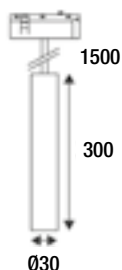

RÉF. ID	PUISSANCE	FLUX	T°	COULEUR	DIMMABLE	PRIX HTVA
ID/03126288	8W	470 LM	3000°K	● NOIR MAT	NON	€ 70,00
ID/03126287	8W	487 LM	4000°K	● NOIR MAT	NON	€ 70,00
ID/03382968	8W	470 LM	3000°K	● NOIR MAT	DALI	€ 150,00
ID/03382967	8W	487 LM	4000°K	● NOIR MAT	DALI	€ 150,00

IRO 2

LED 3 ANS IP20 50° IRC >80 ↑ A+ ↩

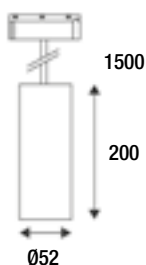

RÉF. ID	PUISSANCE	FLUX	T°	COULEUR	DIMMABLE	PRIX HTVA
ID/03126290	19W	1215 LM	3000°K	● NOIR MAT	NON	€ 99,00
ID/03126289	19W	1651 LM	4000°K	● NOIR MAT	NON	€ 99,00
ID/03382970	19W	1215 LM	3000°K	● NOIR MAT	DALI	€ 170,00
ID/03382969	19W	1651 LM	4000°K	● NOIR MAT	DALI	€ 170,00



BOO 1

LED 3 ANS IP20 45° IRC >80 ↑ A+ ↩

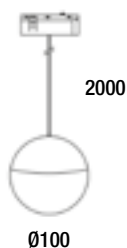

- Livrée avec une longueur de câble réglable de 2m

RÉF. ID	PUISSANCE	FLUX	T°	COULEUR	DIMMABLE	PRIX HTVA
ID/03126292	8W	540 LM	3000°K	● NOIR MAT	NON	€ 125,00
ID/03126291	8W	560 LM	4000°K	● NOIR MAT	NON	€ 125,00
ID/03382972	6.3W	580 LM	3000°K	● NOIR MAT	DALI	€ 190,00
ID/03382971	6.3W	600 LM	4000°K	● NOIR MAT	DALI	€ 190,00

BOO 2

LED 3 ANS IP20 45° IRC >80 ↑ A+ ↩

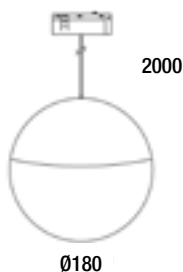

- Livrée avec une longueur de câble réglable de 2m
- Avec interrupteur (Touch Dim)

RÉF. ID	PUISSANCE	FLUX	T°	COULEUR	DIMMABLE	PRIX HTVA
ID/03126294	36W	1780 LM	3000°K	● NOIR MAT	TOUCH DIM	€ 280,00
ID/03126293	36W	2180 LM	4000°K	● NOIR MAT	TOUCH DIM	€ 280,00
ID/03382974	21W	1794 LM	3000°K	● NOIR MAT	DALI	€ 320,00
ID/03382973	21W	1955 LM	4000°K	● NOIR MAT	DALI	€ 320,00



LUMINAIRES AVEC DÉTECTEUR

PAGES 290 À 309

Choisir un luminaire avec détecteur intégré, c'est associer le côté fonctionnel d'un éclairage à une gestion économique et pratique de ses conditions d'allumage. Une solution idéale pour certaines pièces de la maison comme des couloirs, halls d'entrée... ainsi que pour des parties communes d'immeubles et pour les extérieurs.



LUMINAIRES AVEC DÉTECTEUR



DÉTECTEURS



LUMINAIRES AVEC DÉTECTEUR

SF CIRCULAR SENSOR



- Réglage facile de la portée du détecteur, de la détection de la lumière du jour et de la temporisation

RÉF. ID	PUISSANCE	FLUX	T°	TEMPORISATION	PORTÉE	COULEUR	DIAMETRE MM	MATÉRIAU	PRIX HTVA
ID/03223877	13W	1440 LM	3000°K	5S - 10MIN	8M	○ BLANC	Ø 250 X 91	METAL/PMMA	€ 63,00
ID/03223878	13W	960 LM	4000°K	5S - 10MIN	8M	○ BLANC	Ø 250 X 91	METAL/PMMA	€ 63,00
ID/03223879	18W	1440 LM	3000°K	5S - 10MIN	8M	○ BLANC	Ø 350 X 115	METAL/PMMA	€ 70,00
ID/03223880	18W	1440 LM	4000°K	5S - 10MIN	8M	○ BLANC	Ø 350 X 115	METAL/PMMA	€ 70,00
ID/03223881	24W	1920 LM	3000°K	5S - 10MIN	8M	○ BLANC	Ø 400 X 120	METAL/PMMA	€ 77,00
ID/03223882	24W	1920 LM	4000°K	5S - 10MIN	8M	○ BLANC	Ø 400 X 120	METAL/PMMA	€ 77,00

Disponible sans détecteur page 102

BAMBURGH DET

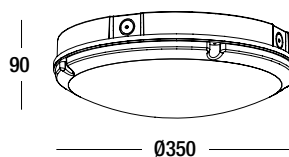
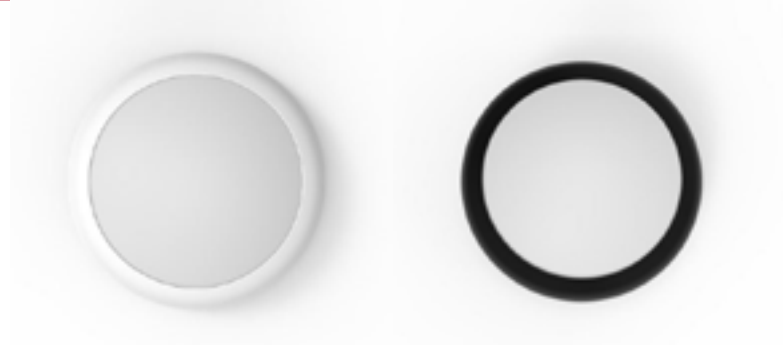

NEW

RÉF. ID	PUISSANCE	FLUX	T°	TEMPORISATION	PORTÉE	COULEUR	MATÉRIAU	PRIX HTVA
ID/03473174	12W	1470 LM	4000°K	5S - 10MIN	5M	○ BLANC	ABS	€ 66,00
ID/03473182	12W	1330 LM	4000°K	5S - 10MIN	5M	● NOIR	ABS	€ 66,00
ID/03473178	18W	2100 LM	4000°K	5S - 10MIN	5M	○ BLANC	ABS	€ 80,00
ID/03473186	18W	1900 LM	4000°K	5S - 10MIN	5M	● NOIR	ABS	€ 80,00

Disponible sans détecteur page 102
Disponible avec détecteur et secours page 424

LUMINAIRES AVEC DÉTECTEUR

ALIEN MINI DET

LED IP54 120° IRC 80 IK10 ← ↑ A+ 230V ← →



- Polycarbonate auto-extinguible V2 de 2 mm d'épaisseur.
- Classe 2 : double isolation.
- Conformité à la norme CEI EN 60598-2-22

RÉF. ID	PUISSANCE	FLUX	T°	TEMPORISATION	PORTÉE	COULEUR	MATÉRIAU	PRIX HTVA
ID/03136832	13W	1300 LM	3000°K	10S - 15MIN	6M	○ BLANC	POLYCARBONATE	€ 126,00
ID/03136834	13W	1300 LM	3000°K	10S - 15MIN	6M	● NOIR	POLYCARBONATE	€ 126,00
ID/03136828	13W	1300 LM	4000°K	10S - 15MIN	6M	○ BLANC	POLYCARBONATE	€ 126,00
ID/03136830	13W	1300 LM	4000°K	10S - 15MIN	6M	● NOIR	POLYCARBONATE	€ 126,00

Disponible sans détecteur page 103

ORKI

LED 3 ANS IP54 120° IRC 85 IK10 ← ↑ A++ A 230V ← →



- 3000K ou 4000K au choix via un interrupteur à l'arrière du luminaire
- Avec détecteur HF 360°

NEW

RÉF. ID	PUISSANCE	FLUX	T°	TEMPORISATION	PORTÉE	COULEUR	MATÉRIAU	PRIX HTVA
ID/03286972	18W	2730 LM	3000 - 4000°K	5S - 10MIN	10 M	○ BLANC	POLYCARBONATE	€ 95,00

Disponible sans détecteur page 110



LUMINAIRES AVEC DÉTECTEUR

CLX+ HF

LED 5 ANS IP65 IRC 80 IK10 A++ A 230V

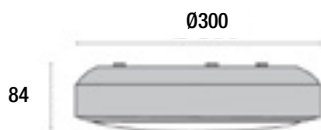

- Joint en silicone anti vieillissement
- Appareil livré avec platine LED SMD à entretien facile et basculante
- Appareil avec sélecteur à dip-switch pour le réglage de la température de couleur de la LED à 3000K ou 4000K

RÉF. ID	PUISSANCE	FLUX	T°	COULEUR	MATÉRIAU	PRIX HTVA
ID/02731370	14,5W	1610 LM	3000 - 4000°K	○ BLANC	TECHNOPOLYMÈRE	€ 85,00

Disponible sans détecteur page 103
Disponible avec détecteur et secours page 425

MOON DET

LED 3 ANS IP54 110° IRC 80 A++ A 230V

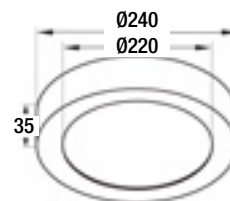
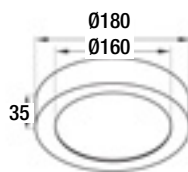

- Les commutateurs DIP permettent de régler la sensibilité et la temporisation

RÉF. ID	PUISSANCE	FLUX	T°	TEMPORISATION	COULEUR	DIAMÈTRE MM	MATÉRIAU	PRIX HTVA
ID/02578890	14W	1200 LM	3000°K	5S - 10MIN	○ BLANC	Ø 180 X 35	ALUMINIUM	€ 82,00
ID/02877017	14W	1200 LM	3000°K	5S - 10MIN	● NOIR	Ø 180 X 35	ALUMINIUM	€ 82,00
ID/02578891	18W	1600 LM	3000°K	5S - 10MIN	○ BLANC	Ø 240 X 35	ALUMINIUM	€ 92,00
ID/02877018	18W	1600 LM	3000°K	5S - 10MIN	● NOIR	Ø 240 X 35	ALUMINIUM	€ 92,00

Disponible avec détecteur et secours page 425



LUMINAIRES AVEC DÉTECTEUR

ASPI 1 SENSOR

LED 3 ANS IP54 110° IRC >80 IK10 ← ↑ A++ A 230V ← →

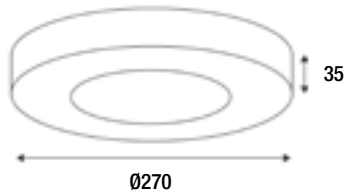

- Avec détecteur HF 360° (plafond) 150° (mur)
- Diffuseur en polycarbonate opalin
- Convertisseur non dimmable intégré dans l'appareil

RÉF. ID	PUISSANCE	FLUX	T°	TEMPORISATION	PORTÉE	COULEUR	MATÉRIAU	PRIX HTVA
ID/02661287	25W	2000 LM	4000°K	5S - 30MIN	12 M	● ANTHRACITE	ALUMINIUM	€ 170,00

ASPI 2 SENSOR

LED 3 ANS IP54 110° IRC >80 IK10 ← ↑ A++ A 230V ← →

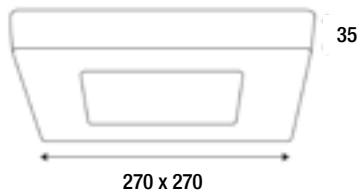

- Avec détecteur HF 360° (plafond) 150° (mur)
- Diffuseur en polycarbonate opalin
- Convertisseur non dimmable intégré dans l'appareil

RÉF. ID	PUISSANCE	FLUX	T°	TEMPORISATION	PORTÉE	COULEUR	MATÉRIAU	PRIX HTVA
ID/02661288	25W	2000 LM	4000°K	5S - 30MIN	12 M	● ANTHRACITE	ALUMINIUM	€ 170,00

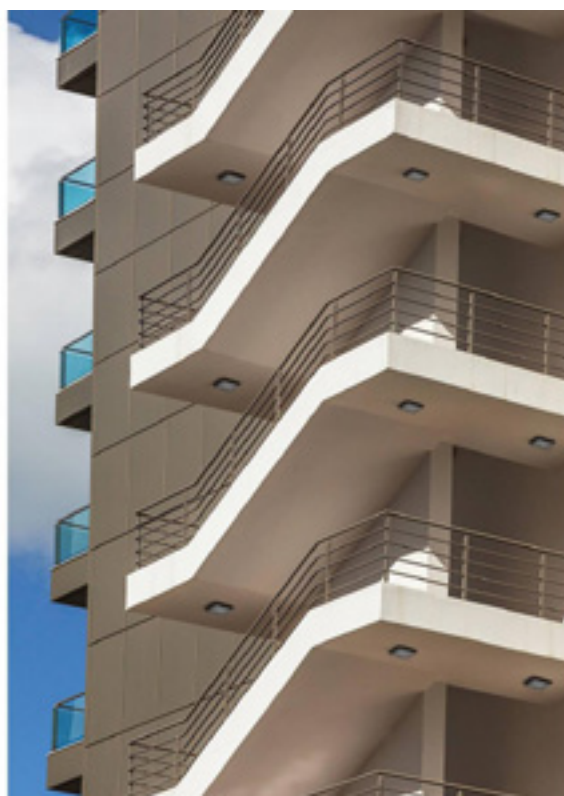

LUMINAIRES AVEC DÉTECTEUR

ASPI 1 SENSOR PLUS LED 3 ANS IP54 110° IRC >80 IK10 ← ↑ A++ A 230V ← →

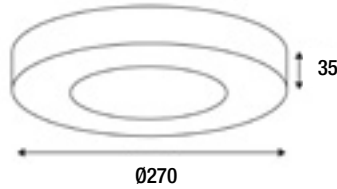

- 3000K ou 4000K au choix via un interrupteur dans le luminaire
- Avec détecteur HF 360° (plafond) 150° (mur), zone de détection réglable max. 12m de diamètre
- Diffuseur en polycarbonate opalin
- Convertisseur non dimmable intégré dans l'appareil

NEW

RÉF. ID	PUISSANCE	FLUX	T°	TEMPORISATION	PORTÉE	COULEUR	MATÉRIAU	PRIX HTVA
ID/03382908	30W	3000 LM	3000 - 4000°K	5S - 30MIN	12 M	● ANTHRACITE	ALUMINIUM	€ 180,00
ID/03382909	30W	3000 LM	4000 - 3000°K	5S - 30MIN	12 M	○ BLANC MAT	ALUMINIUM	€ 180,00

ASPI 2 SENSOR PLUS LED 3 ANS IP54 110° IRC >80 IK10 ← ↑ A++ A 230V ← →

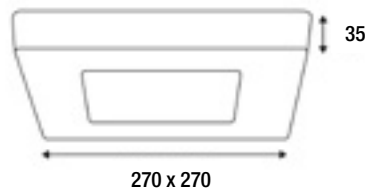

- 3000K ou 4000K au choix via un interrupteur dans le luminaire
- Avec détecteur HF 360° (plafond) 150° (mur), zone de détection réglable max. 12m de diamètre
- Diffuseur en polycarbonate opalin
- Convertisseur non dimmable intégré dans l'appareil

NEW

RÉF. ID	PUISSANCE	FLUX	T°	TEMPORISATION	PORTÉE	COULEUR	MATÉRIAU	PRIX HTVA
ID/03382910	30W	3000 LM	3000 - 4000°K	5S - 30MIN	12 M	● ANTHRACITE	ALUMINIUM	€ 180,00
ID/03382911	30W	3000 LM	3000 - 4000°K	5S - 30MIN	12 M	○ BLANC MAT	ALUMINIUM	€ 180,00



LUMINAIRES AVEC DÉTECTEUR

FRAME ROUND DET

LED 5 ANS IP66 110° IRC >80 IK10 A++ A 230V



- Corps: Fonte d'aluminium
- Diffuseur: polycarbonate résistant aux UV
- Platine LED remplaçable

ANTI CORROSION GARANTIE 10 ANS

RÉF. ID	PUISSANCE	FLUX	T°	TEMPORISATION	PORTÉE	COULEUR	PRIX HTVA
ID/02628686	7 W	670 LM	3000°K	5S- 30 MIN	6M	○ BLANC	€ 183,00
ID/02628707	7 W	670 LM	3000°K	5S- 30 MIN	6M	● NOIR	€ 183,00
ID/02628689	7 W	670 LM	3000°K	5S- 30 MIN	6M	● GRAPHITE	€ 183,00

Disponible sans détecteur page 392

FRAME SQUARE DET

LED 5 ANS IP66 110° IRC >80 IK10 A++ A 230V



- Corps: Fonte d'aluminium
- Diffuseur: polycarbonate résistant aux UV
- Platine LED remplaçable

ANTI CORROSION GARANTIE 10 ANS

RÉF. ID	PUISSANCE	FLUX	T°	TEMPORISATION	PORTÉE	COULEUR	PRIX HTVA
ID/02628711	6 W	500 LM	3000°K	5S- 30 MIN	6M	○ BLANC	€ 183,00
ID/02628737	6 W	500 LM	3000°K	5S- 30 MIN	6M	● NOIR	€ 183,00
ID/02628715	6 W	500 LM	3000°K	5S- 30 MIN	6M	● GRAPHITE	€ 183,00

Disponible sans détecteur page 392

LUMINAIRES AVEC DÉTECTEUR

FRAME ROUND MAXI DET

LED 5 ANS IP66 110° IRC 80 IK10 ← A++ A 230V



- Corps: Fonte d'aluminium
- Diffuseur: polycarbonate résistant aux UV
- Platine LED remplaçable

ANTI CORROSION GARANTIE 10 ANS

NEW

RÉF. ID	PUISSANCE	FLUX	T°	TEMPORISATION	PORTÉE	COULEUR	PRIX HTVA
ID/02628693	22W	1960 LM	3000°K	5S - 30MIN	6M	○ BLANC	€ 236,00
ID/02628698	22W	1960 LM	3000°K	5S - 30MIN	6M	● GRAPHITE	€ 236,00
ID/02628703	22W	1960 LM	3000°K	5S - 30MIN	6M	● NOIR	€ 236,00

Disponible en plafonnier page 403

FRAME SQUARE MAXI DET

LED 5 ANS IP66 110° IRC 80 IK10 ← A++ A 230V



- Corps: Fonte d'aluminium
- Diffuseur: polycarbonate résistant aux UV
- Platine LED remplaçable

ANTI CORROSION GARANTIE 10 ANS

NEW

RÉF. ID	PUISSANCE	FLUX	T°	TEMPORISATION	PORTÉE	COULEUR	PRIX HTVA
ID/02628720	21W	1980 LM	3000°K	5S - 30MIN	6M	○ BLANC	€ 236,00
ID/02628725	21W	1980 LM	3000°K	5S - 30MIN	6M	● GRAPHITE	€ 236,00
ID/02628731	21W	1980 LM	3000°K	5S - 30MIN	6M	● NOIR	€ 236,00

Disponible en plafonnier page 403



LUMINAIRES AVEC DÉTECTEUR

TEXAS + DÉTECTEUR

LED 5 ANS IP54 ← 230V

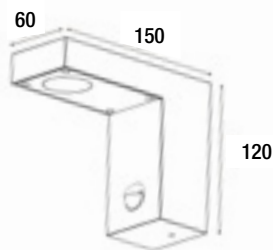

- Détecteur infra-rouge
- Angle de détection de 120°

RÉF. ID	PUISSANCE	FLUX	T°	TEMPORISATION	PORTÉE	COULEUR	PRIX HTVA
ID/01732571	6W	230 LM	3000°K	5S - 8MIN	9M	● ANTHRACITE	€ 116,00

Disponible sans détecteur page 366

BORNE TEXAS + DÉTECTEUR

LED 5 ANS IP54 ↓ 230V

LUMINAIRES AVEC DÉTECTEURS

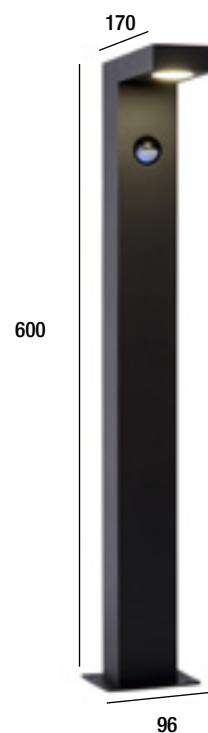

RÉF. ID	PUISSANCE	FLUX	T°	TEMPORISATION	PORTÉE	COULEUR	PRIX HTVA
ID/01732572	6W	230 LM	3000°K	5S - 8MIN	9M	● ANTHRACITE	€ 130,00

Disponible sans détecteur page 337

LUMINAIRES AVEC DÉTECTEUR

TULO DET

3
ANS

IP54



IRC
80

IK05



A++
A

230V



- Détecteur infra-rouge
- Angle de détection de 100°
- Diffuseur en verre clair

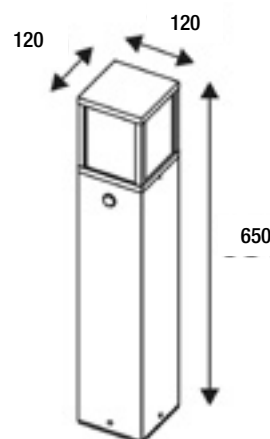

NEW

RÉF. ID	CULOT	PUISSANCE MAX	FLUX MAX	TEMPORISATION	PORTÉE	COULEUR	MATÉRIAU	PRIX HTVA
ID/03286988	E27	MAX 9W	800 LM	5S - 8MIN	8M	● ANTHRACITE	ALUMINIUM/ VERRE	€ 169,00

Disponible sans détecteur page 340

LUMINAIRES AVEC DÉTECTEURS



LUMINAIRES AVEC DÉTECTEURS



LUMINAIRES AVEC DÉTECTEUR

NORD

LED IP65 IRC 80

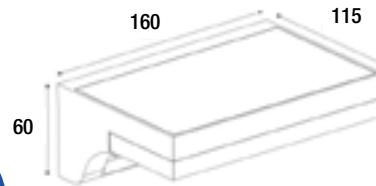

- Diffuseur en plexiglas opalin

Le conseil de l'éclairagiste:

Avec une évolution technique importante ces dernières années, les luminaires à énergie solaire permettent d'amener un éclairage fiable là où les arrivées électriques font défaut.

NEW

RÉF. ID	PUISSANCE	FLUX	T°	PORTÉE	COULEUR	MATÉRIAU	PRIX HTVA
ID/03468840	2W	268 LM	3000°K	5M	● NOIR	ALUMINIUM	€ 68,00

CASAR

LED IP65 IRC 80

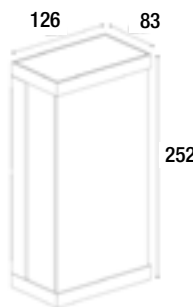

- Diffuseur en plexiglas opalin

NEW

RÉF. ID	PUISSANCE	FLUX	T°	PORTÉE	COULEUR	MATÉRIAU	PRIX HTVA
ID/03468842	2W	300 LM	3000°K	5M	● NOIR	ALUMINIUM	€ 82,00

CLAIRETTE A

LED 3 ANS IP54 230V

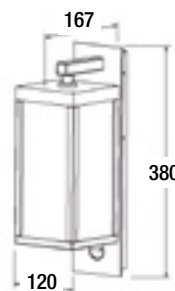

- Diffuseur en verre transparent
- Angle de détection de 120°

NEW

RÉF. ID	PUISSANCE	FLUX	T°	TEMPORISATION	PORTÉE	COULEUR	MATÉRIAU	PRIX HTVA
ID/02695405	15W	650 LM	3000°K	5S - 10MIN	10M	● ANTHRACITE	ALUMINIUM	€ 132,00



LUMINAIRES AVEC DÉTECTEUR

E PRO FLOOD SENSOR

LED 3 ANS IP55 100° IRC 80 IK05 ← A++ A 230V

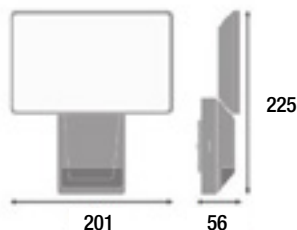

- Sélection parmi 4 modes de fonctionnement
- Angle de détection de 180°

Le conseil de l'éclairagiste:

Un spot extérieur puissant avec détecteur intégré permet autant d'éclairer une grande terrasse ou une partie importante de jardin que de participer à la sécurisation de la propriété.

NEW

RÉF. ID	PUISSANCE	FLUX	T°	TEMPORISATION	PORTÉE	COULEUR	MATÉRIAU	PRIX HTVA
ID/03223712	27W	3000 LM	4000°K	2 S - 15MIN	12M	● GRIS NOIR	POLYCARBONATE	€ 159,00

E PRO SPOT SENSOR

LED 3 ANS IP55 50° IRC 80 IK05 ← A++ A 230V

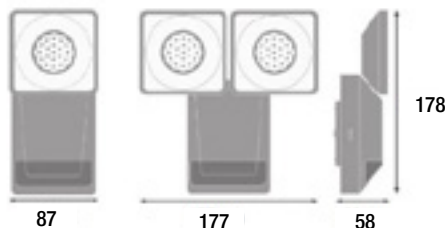

- Sélection parmi 4 modes de fonctionnement
- Angle de détection de 180°

LUMINAIRES AVEC DÉTECTEURS

NEW

RÉF. ID	PUISSANCE	FLUX	T°	TEMPORISATION	PORTÉE	COULEUR	MATÉRIAU	PRIX HTVA
ID/03223714	8W	750 LM	4000°K	2 S - 15MIN	12M	● GRIS NOIR	POLYCARBONATE	€ 92,00
ID/03223716	2 X 8W	2 X 750 LM	4000°K	2 S - 15MIN	12M	● GRIS NOIR	POLYCARBONATE	€ 159,00

LUXI 45 SENSOR

LED IP54 120° IRC >80 ← A++ A 230V

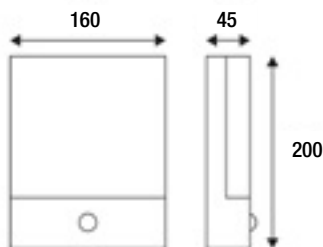

- Avec détecteur IR 120°, zone de détection réglable
- Diffuseur en polycarbonate opalin
- Convertisseur non dimmable intégré dans l'appareil

RÉF. ID	PUISSANCE	FLUX	T°	TEMPORISATION	PORTÉE	COULEUR	MATÉRIAU	PRIX HTVA
ID/03126800	6W	660 LM	3000°K	5S - 8MIN	6M	● ANTHRACITE	ALUMINIUM	€ 130,00

LUMINAIRES AVEC DÉTECTEUR

LUXI 175 SENSOR

LED IP54 105° IRC >80 230V



- Avec détecteur HF 120°, zone de détection réglable
- Diffuseur en polycarbonate opalin
- Convertisseur non dimmable intégré dans l'appareil

RÉF. ID	PUISSANCE	FLUX	T°	TEMPORISATION	PORTÉE	COULEUR	MATÉRIAU	PRIX HTVA
ID/02661292	9W	1080 LM	4000°K	5S - 15MIN	8M	○ BLANC	ALUMINIUM	€ 170,00
ID/02661291	9W	1080 LM	4000°K	5S - 15MIN	8M	● ANTHRACITE	ALUMINIUM	€ 170,00

LUXI 175 SENSOR P

LED IP54 105° IRC >80 230V



- Avec détecteur HF 120°, zone de détection réglable
- Diffuseur en polycarbonate opalin
- Convertisseur non dimmable intégré dans l'appareil

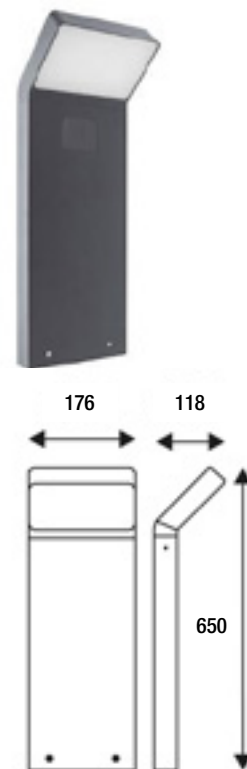

RÉF. ID	PUISSANCE	FLUX	T°	TEMPORISATION	PORTÉE	COULEUR	MATÉRIAU	PRIX HTVA
ID/03126807	9W	1080 LM	4000°K	5S - 15MIN	8M	● ANTHRACITE	ALUMINIUM	€ 225,00

DÉTECTEURS

DÉTECTEURS 200

4 ANS

IP55



230V

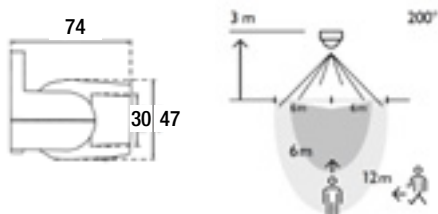

Ce détecteur de mouvement à 1 canal convient pour une utilisation intérieure ou extérieure

- Réglage manuel séparé des lux et de la temporisation

Le conseil de l'éclairagiste:

Un détecteur indépendant permet de commander l'allumage d'un ou plusieurs luminaires sans devoir actionner celui-ci manuellement. Une solution aussi pratique que sécurisante, autant par exemple pour un hall de nuit que pour un éclairage dissuasif à l'extérieur.

NEW

RÉF. ID	TEMPORISATION	CREPUSCULAIRE	CHARGE MAX	ANGLE	PORTÉE	COULEUR	PRIX HTVA
ID/02740105	10S - 20MIN	5-2000LUX	HALO : 2300W LED : 350W	200°	12M	○ BLANC	€ 60,00
ID/02792649	10S - 20MIN	5-2000LUX	HALO : 2300W LED : 350W	200°	12M	● ALU	€ 60,00
ID/02740106	10S - 20MIN	5-2000LUX	HALO : 2300W LED : 350W	200°	12M	● NOIR	€ 60,00

DÉTECTEURS 240

4 ANS

IP54







230V

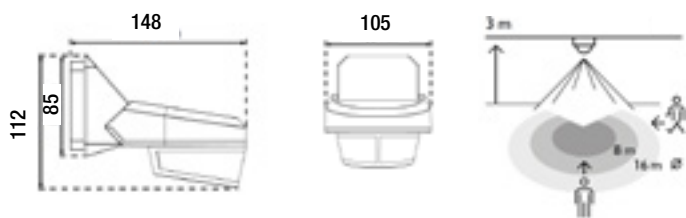

Ce détecteur de mouvement à 1 canal convient pour une utilisation intérieure ou extérieure

- Capteur de lumière intégré avec commutation automatique ou manuelle via bouton poussoir N.G.
- Fourni avec une télécommande utilisateur avec fonction on/off, test et détection animaux on/off
- Réglages manuels



RÉF. ID	TEMPORISATION	CREPUSCULAIRE	CHARGE MAX	ANGLE	PORTÉE	COULEUR	PRIX HTVA
ID/02289180	10S - 20MIN	5-2000LUX	HALO : 2000W LED : 300W	240°	16M	○ BLANC	€ 107,00
ID/02289181	10S - 20MIN	5-2000LUX	HALO : 2000W LED : 300W	240°	16M	● ALU	€ 107,00
ID/02289182	10S - 20MIN	5-2000LUX	HALO : 2000W LED : 300W	240°	16M	● NOIR	€ 107,00
ID/02289136						ÉTRIER DE MONTAGE POUR COIN BLANC	€ 12,00
ID/02289137						ÉTRIER DE MONTAGE POUR COIN ALU	€ 12,00
ID/02289138						ÉTRIER DE MONTAGE POUR COIN NOIR	€ 12,00

DÉTECTEUR 360

4 ANS

IP55



230V

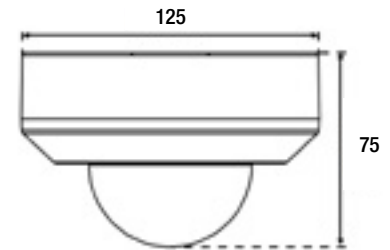
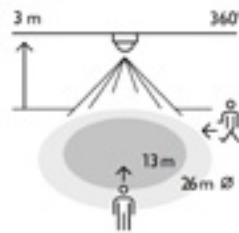

NEW

RÉF. ID	TEMPORISATION	CREPUSCULAIRE	CHARGE MAX	ANGLE	PORTÉE	COULEUR	PRIX HTVA
ID/02289154	10S - 20MIN	5-2000LUX	HALO : 2300W LED : 350W	360°	13M	○ BLANC	€ 100,00
ID/02289159						TÉLÉCOMMANDE IR POUR INSTALLATEUR (OPTION)	€ 32,00

MINI DÉTECTEUR 360 ENCASTRÉ

IP65



230V

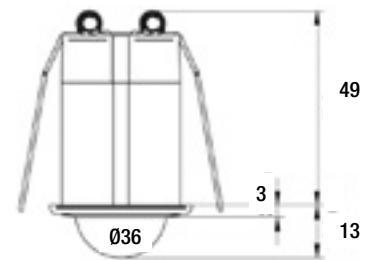
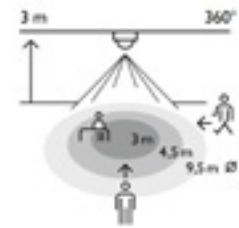

RÉF. ID	TEMPORISATION	CREPUSCULAIRE	CHARGE MAX	ANGLE	PORTÉE	ENCASTREMENT MM	COULEUR	PRIX HTVA
ID/01449633	2MIN - 60MIN	20-1000LUX	HALO : 2300W LED : 350W	360°	9,5M	Ø30	○ BLANC	€ 113,00
ID/01449635							TÉLÉCOMMANDE IR REQUISE POUR MISE EN SERVICE	€ 32,00

LUMINAIRES AVEC DÉTECTEURS



BRANCHEMENT DU DÉTECTEUR AVEC UN INTERRUPTEUR POUR MARCHÉ FORCÉE

Le schéma de branchement électrique ci-dessous vous permet de coupler un détecteur de mouvements IR à un interrupteur va et vient pour permettre de forcer l'allumage du point lumineux sans s'occuper des ordres donnés par le détecteur de mouvements.

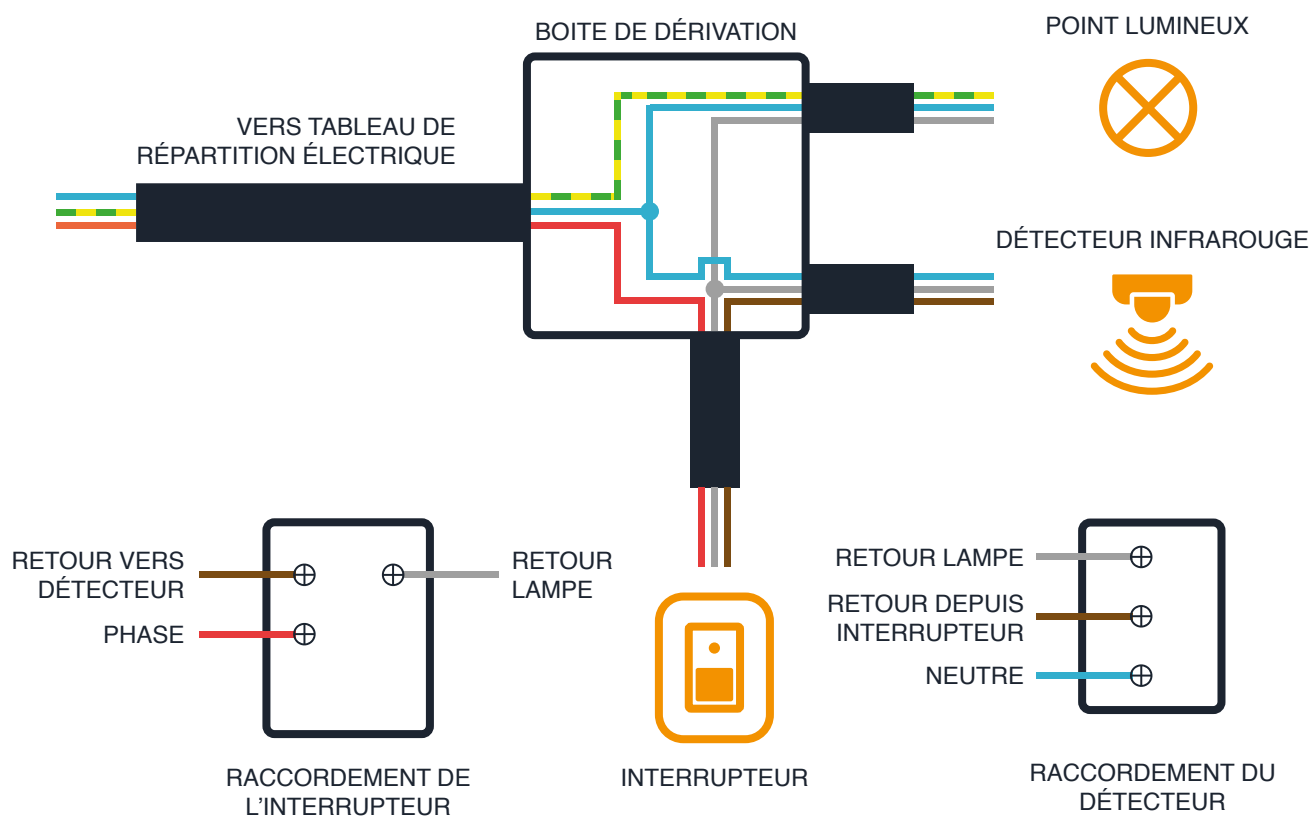

BRANCHEMENT DU DÉTECTEUR AVEC UN INTERRUPTEUR POUR EXTINCTION FORCÉE

Le schéma de branchement électrique ci-dessous vous permet de venir forcer l'extinction en interrompant l'alimentation du détecteur de mouvements.

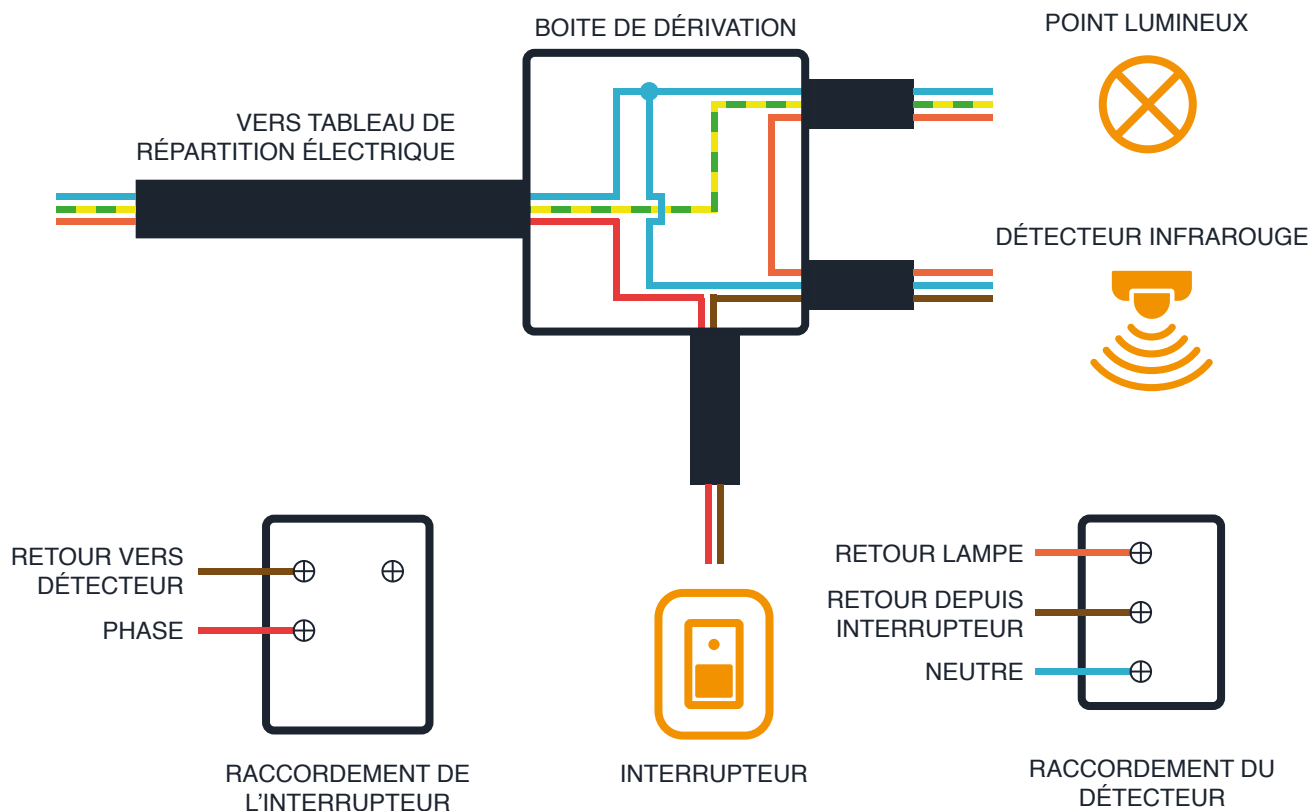

BALISAGES INTÉRIEURS

PAGES 310 À 315

Compacts et très peu énergivores, les luminaires de balisage intérieur sécurisent vos espaces de circulation comme des escaliers et couloirs. Pensez à les coupler à un détecteur dans vos halls de nuit pour encore plus de confort pour toute la famille.



BALISAGES INTÉRIEURS



SPRINGFIELD
312



FONDA
312



LIKA
312



ANTIBES
313



BRISTOL
313



LAK
314



BALI CARRÉ
314



BIARRITZ
315

BALISAGES INTÉRIEURS

SPRINGFIELD

LED 3 ANS IP54 IRC >80

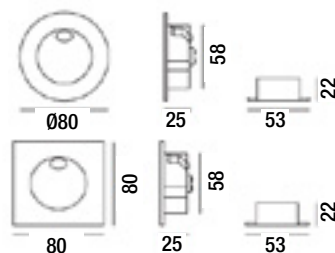

- Compatible avec blochet profond paroi creuse
- Alimentation déportée incluse

RÉF. ID	PUISSANCE	FLUX	T°	COULEUR	FORME	ENCASTREMENT	PRIX HTVA
ID/02122178	2W	50 LM	3000°K	○ BLANC	ROND	BLOCHET 68	€ 47,00
ID/02122179	2W	50 LM	3000°K	○ BLANC	CARRÉ	BLOCHET 68	€ 47,00

FONDA

LED IP20 IRC 80

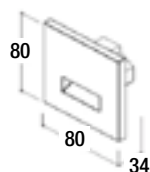
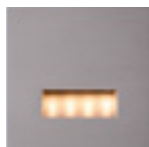
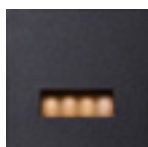
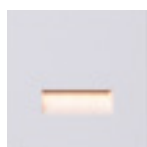

- Compatible avec blochet profond paroi creuse.

RÉF. ID	PUISSANCE	FLUX	T°	COULEUR	ENCASTREMENT	PRIX HTVA
ID/01594529	1W	60 LM	3000°K	○ BLANC	BLOCHET 68	€ 74,00
ID/01594528	1W	60 LM	3000°K	● NOIR	BLOCHET 68	€ 74,00
ID/01594527	1W	60 LM	3000°K	● ALU BROSSE	BLOCHET 68	€ 74,00

LIKA

LED 3 ANS IP23 IRC >80

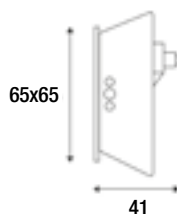

- Fixation par lamelles
- Boîtier d'encastrement inclus

RÉF. ID	PUISSANCE	FLUX	T°	COULEUR	ENCASTREMENT MM	PRIX HTVA
ID/02682274	4W	330 LM	3000°K	○ BLANC	Ø 56	€ 70,00
ID/02682273	4W	330 LM	3000°K	● NOIR	Ø 56	€ 70,00

BALISAGES INTÉRIEURS

ANTIBES

LED 3 ANS IP20 115° IRC ≥90

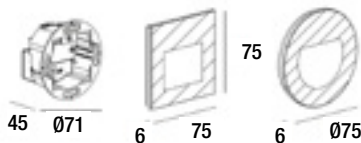

- Compatible avec blochet profond paroi creuse
- Plaque de finition en verre

NEW

RÉF. ID	PUISSANCE	FLUX	T°	COULEUR	FORME	ENCASTREMENT MM	PRIX HTVA
ID/03473229	1.5W	30 LM	3000°K	○ BLANC	ROND	BLOCHET 68	€ 79,00
ID/03473230	1.5W	30 LM	3000°K	○ BLANC	CARRÉ	BLOCHET 68	€ 79,00

BRISTOL

LED 3 ANS IP43 >80

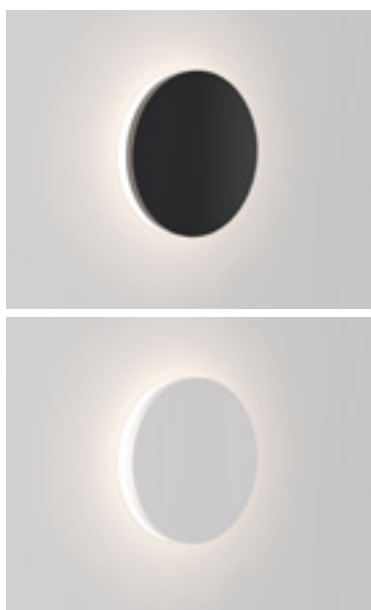

- Compatible avec blochet profond paroi creuse
- Boîtier d'encastrement inclus
- Alimentation déportée incluse

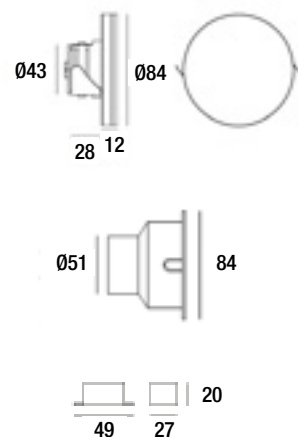

RÉF. ID	PUISSANCE	FLUX	T°	COULEUR	ENCASTREMENT	PRIX HTVA
ID/02679184	4,6W	470 LM	3000°K	○ BLANC	BLOCHET 68	€ 80,00
ID/02679186	4,6W	470 LM	3000°K	● NOIR	BLOCHET 68	€ 80,00
ID/02679185	4,6W	495 LM	4000°K	○ BLANC	BLOCHET 68	€ 80,00
ID/02679187	4,6W	495 LM	4000°K	● NOIR	BLOCHET 68	€ 80,00

BALISAGES INTÉRIEURS

LAK

LED 5 ANS IP54 IRC 80   A++ A 230V  



- Faisceau asymétrique
- Boîtier d'encastrement inclus diamètre 63 mm intérieur & 70 mm extérieur

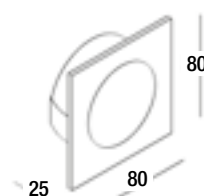

RÉF. ID	PUISSANCE	FLUX	T°	COULEUR	ENCASTREMENT MM	PRIX HTVA
ID/02846143	2W	150 LM	3000°K	○ BLANC	Ø 70	€ 69,00
ID/02846144	2W	150 LM	3000°K	● NOIR	Ø 70	€ 69,00

BALISAGES INTÉRIEURS

BALI CARRÉ

LED 5 ANS IP20 IRC >80   A++ A 230V 

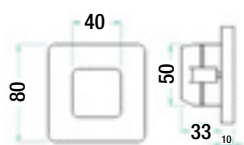

- Compatible avec blochet profond paroi creuse
- Luminaire à double effet : diffusion frontale et éclairage rasant

RÉF. ID	PUISSANCE	FLUX	T°	COULEUR	ENCASTREMENT	PRIX HTVA
ID/02484258	0,93W	16 LM	3100°K	○ BLANC	BLOCHET 68	€ 53,00
ID/02484254	0,93W	16 LM	3100°K	● NOIR	BLOCHET 68	€ 53,00
ID/02484256	0,93W	16 LM	3100°K	● CRÈME	BLOCHET 68	€ 53,00
ID/02484252	1,1W	22 LM	5900°K	○ BLANC	BLOCHET 68	€ 53,00
ID/02484250	1,1W	22 LM	5900°K	● NOIR	BLOCHET 68	€ 53,00

BALISAGES INTÉRIEURS

BIARRITZ

LED

3 ANS

IP20

75°

IRC ≥90



A++ A

230V



- Compatible avec blochet profond paroi creuse.

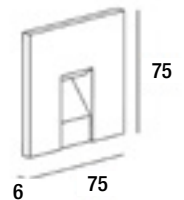

NEW

RÉF. ID	PUISSANCE	FLUX	T°	COULEUR	FORME	ENCASTREMENT MM	PRIX HTVA
ID/03383111	1,5W	136 LM	3000°K	○ BLANC	ROND	BLOCHET 68	€ 69,00
ID/03383112	1,5W	136 LM	3000°K	● NOIR	ROND	BLOCHET 68	€ 69,00
ID/03383113	1,5W	136 LM	3000°K	○ BLANC	CARRÉ	BLOCHET 68	€ 69,00
ID/03383114	1,5W	136 LM	3000°K	● NOIR	CARRÉ	BLOCHET 68	€ 69,00



BALISAGES INTÉRIEURS



ENCASTRÉS DE SOL

PAGES 316 À 327

Que ce soit pour baliser terrasses, chemins et allées ou mettre en évidence un bel arbre ou la façade d'un bâtiment, les encastrés de sol représentent une solution hyper-fonctionnelle qui s'intègre avec beaucoup de discrétion à son environnement.

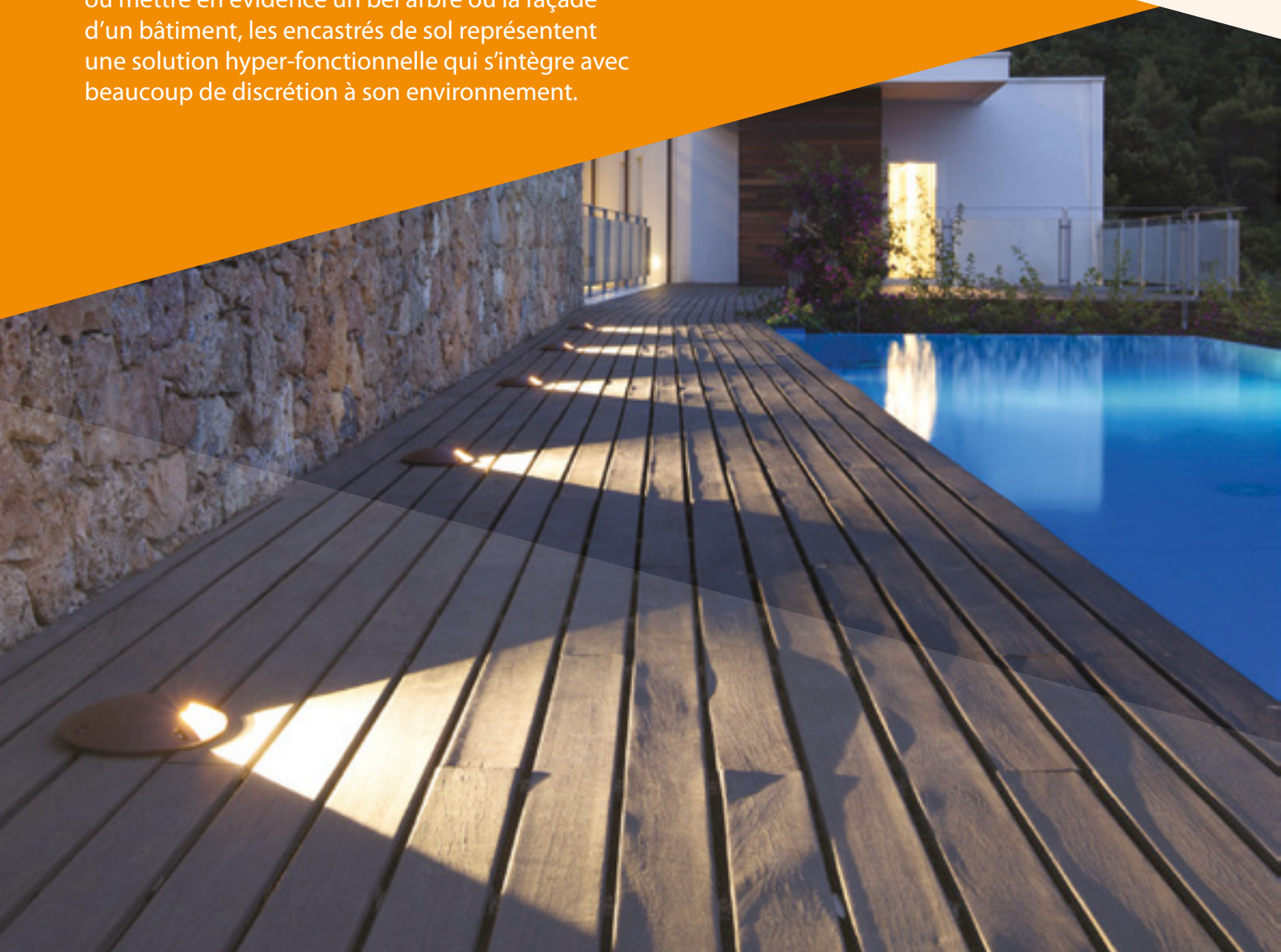

ENCASTRÉS DE SOL



NEW
MAGIC POWER
GEL
319



NEW
MANCHON À GEL
319



TIDIAN
320



RINGO
320



ATLANTIS II
320



MONTE CARLO
321



BALI
321



BOMBAY
322



HYDROLED
322



HYDROLED
ASYMÉTRIQUE
322



DASAR FLAT 80
323



ARRAS
323



NEW
GYRO
324



NEW
GYRO
ASYMÉTRIQUE
324



NEW
BIG APA RD-230
325



NEW
RODI A
325



KAMINO
326

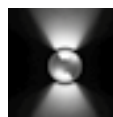

RHO
326

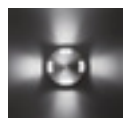

BOLAS
327

ENCASTRÉS DE SOL

MISE EN OEUVRE DES ENCASTRÉS DE SOL

INSTALLATION

Veillez à toujours installer les encastrés de sol sur des surfaces planes voire sur des bosses mais dans tous les cas ne les installez jamais dans des creux car l'accumulation d'eau pourrait venir à bout de l'étanchéité du produit (l'eau monte toujours de façon capillaire). Entourez la boîte d'encastrement avec du matériel de fixation suffisamment robuste de manière à éviter qu'il ne penche ou ne s'effondre.

DRAINAGE:

Il faudra prévoir, un système de drainage comme du gravier, du sable, 30 cm en dessous de l'appareil. Un bon drainage doit permettre l'absorption de 5 litres d'eau en 8 minutes.

RACCORDEMENT ÉLECTRIQUE:

Pour établir la connexion électrique des luminaires encastrés dans le sol, veillez à utiliser des câbles industriels souples avec une isolation en caoutchouc.

CONDENSATION

Afin de minimiser la condensation à l'intérieur du dispositif, faites le fonctionner pendant environ 1 heure sans le verre de protection. Après cela, mettez le verre en place et serrez les vis pour fermer l'appareil. Lorsque vous éteignez l'appareil, celui-ci va refroidir, créer un vide d'air et se mettre sous pression.

RISQUE DE BRÛLURE :

Le diffuseur en verre peut atteindre des températures élevées (supérieur à 90°), évitez donc le contact direct avec le verre sous peine de brûlure (halogène ou iodure). Pour les endroits où vous risquez de marcher dessus pieds nus, nous vous recommandons d'utiliser des appareils led ou lampes fluo-compactes

ENTRETIEN:

Nous vous conseillons de nettoyer régulièrement l'extérieur du luminaire afin d'éviter l'accumulation de saleté et de faciliter la dissipation de la chaleur.

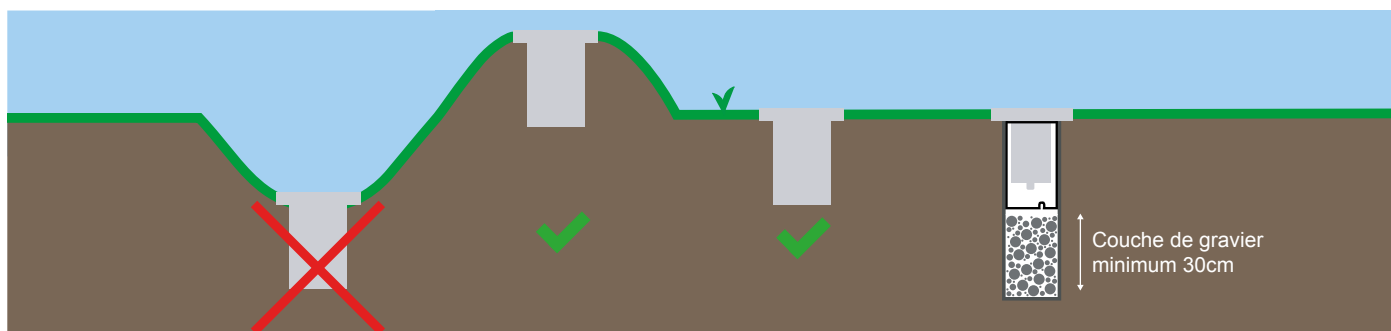

RÉALISATION D'UN RACCORDEMENT ÉTANCHE

Afin que vos spots de sol puissent fonctionner, vous devez naturellement les raccorder au réseau électrique.

C'est ce raccordement que vous devez protéger au mieux contre l'humidité.

La manière la plus sûre d'y parvenir est d'effectuer le branchement dans une boîte de dérivation et de la remplir ensuite de résine. La résine à couler dans la boîte de dérivation garantit que le branchement ainsi que votre spot de sol seront totalement protégés contre l'eau.

Il est également possible d'effectuer le branchement dans des connecteurs étanches avec gel et presse-étoupes.

Le câble du spot de sol s'étend jusqu'à votre boîte de dérivation où est effectué le branchement. Via un câble EXVB, le spot de sol est ensuite raccordé au réseau. Le câble EXVB doit être placé dans une gaine TPC 10 dans le sol. Dans la boîte de dérivation, vous pouvez également réaliser un embranchement pour alimenter ainsi vos autres spots de sol en électricité.

Une fois que le raccordement à la boîte de dérivation a été effectué et que vous avez testé plusieurs fois vos spots, vous pouvez couler la résine dans la boîte de dérivation. Mélangez les composants de la résine et remplissez la boîte de dérivation

jusqu'au bord de manière à ce que les câbles et les connecteurs soient correctement noyés.

La résine durcit en 15 minutes environ. Utilisez toujours les gants fournis lorsque vous travaillez avec de la résine liquide.

Attention : N'oubliez pas de tester vos spots de sol avant de couler la résine. Une fois que la résine est solidifiée, vous ne pouvez plus rien pour votre branchement !

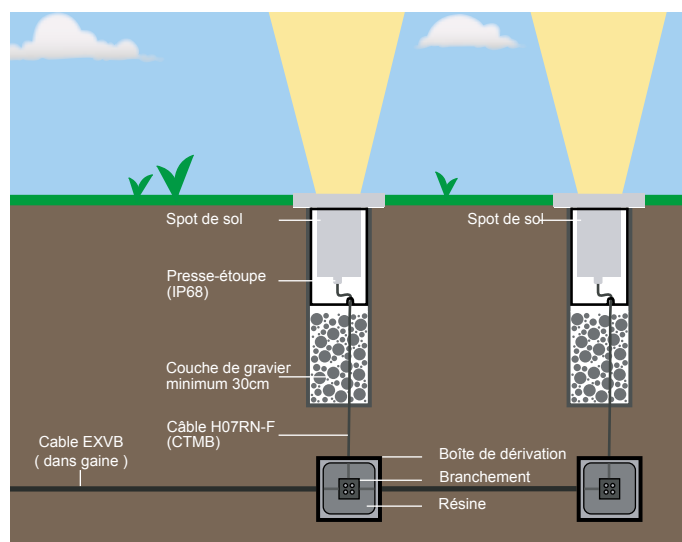

MAGIC POWER GEL



Le seul Gel bi-composant en une seule bouteille aux caractéristiques diélectriques, fixantes et thermiques très élevées, retirable et réutilisable.

- Pouvoir fixant élevé
- Propriétés d'auto-agglomération
- Flacon unique bi-composant compact et pratique
- Réutilisable même après de longues périodes d'utilisation
- N'engendre pas de perte
- Non toxique

NEW

RÉF. ID	TYPE	PRIX HTVA
ID/01429669	MAGIC POWER GEL - SINGLE BOTTLE 1 LITRE	€ 74,00

MANCHON À GEL



BARNEY



FRED-Y

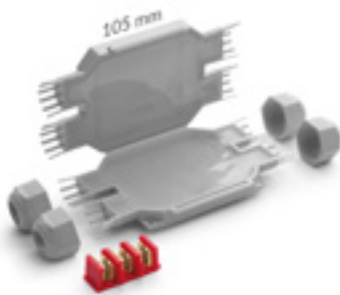

BOB-4

Extrêmement compacts, ils sont préremplis avec un gel souple et extrêmement flexible. Les presse-étoupes intégrés permettent un degré de protection IP68 et IP69K et, au même moment, le blocage de la jonction sur le câble.

- Préremplis avec du gel non toxique
- Produits idéals pour éclairages de jardins, gradins et escaliers, allées ...
- Prêt à l'emploi
- Toujours ré-accessibles
- Sans halogènes & résistants aux UV
- D'autres modèles sur demande

Le conseil de l'éclairagiste:

Une mise en œuvre particulière avec des connecteurs spécifiques est absolument nécessaire afin de garantir une durée de vie maximale à vos luminaires d'extérieur.

Que ce soit à l'aide de manchons étanches ou grâce à des solutions en gel coulées dans une boîte de dérivation, vous éviterez ainsi tout risque de pénétration d'humidité et donc de détérioration de votre installation.

NEW

RÉF. ID	TYPE	PRIX HTVA
ID/03313309	BARNEY AVEC CONNECTEUR 2 X 2,5 MM ²	€ 7,50
ID/03313478	FRED-Y AVEC CONNECTEUR 3 X 4 MM ² < 3 X 2,5 MM ²	€ 20,00
ID/03313330	BOB4 AVEC CONNECTEUR 3 X 4 MM ² < 3 X 2,5 MM ²	€ 23,00

ENCASTRÉS DE SOL

TIDIAN

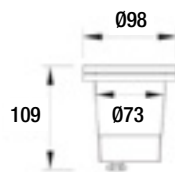

- Idéal pour bord de mer.

RÉF. ID	CULOT	PUISSANCE MAX	FLUX MAX	COULEUR	ENCASTREMENT MM	MATÉRIAU	PRIX HTVA
ID/02612719	GU10	MAX 9W	575 LM	● NOIR	Ø 73	TECHNOPOLYMÈRE	€ 29,00

RINGO



- Inox 304 (bague) - Aluminium
- Boîtier d'encastrement inclus

RÉF. ID	CULOT	PUISSANCE MAX	FLUX MAX	COULEUR	ENCASTREMENT MM	MATÉRIAU	PRIX HTVA
ID/02612718	GU10	MAX 9W	575 LM	● INOX	Ø 108	INOX 304	€ 39,00

ATLANTIS II

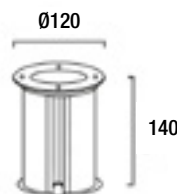

- Boîtier d'encastrement inclus

RÉF. ID	CULOT	PUISSANCE MAX	FLUX MAX	COULEUR	FORME	ENCASTREMENT MM	MATÉRIAU	PRIX HTVA
ID/02877862	GU10	MAX 9W	575 LM	● ALU BROSSÉ	ROND	Ø 98	ALUMINIUM/VERRE	€ 35,00
ID/02877863	GU10	MAX 9W	575 LM	● ALU BROSSÉ	CARRE	Ø 98	ALUMINIUM/VERRE	€ 35,00

ENCASTRÉS DE SOL

MONTE CARLO

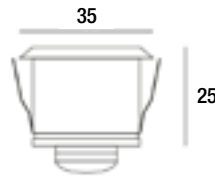

- Fixation lamelles
- Pré-câblé 45cm
- Alimentation 24 Vdc (voir p.444)

RÉF. ID	PUISSANCE	FLUX	T°	FORME	ENCASTREMENT MM	MATÉRIAU	PRIX HTVA
ID/01449011	1W	30 LM	3000°K	ROND	Ø 30 X 26	INOX 316	€ 35,00
ID/01449010	1W	33 LM	4000°K	ROND	Ø 30 X 26	INOX 316	€ 35,00
ID/01604772	1W	30 LM	3000°K	CARRÉ	Ø 30 X 26	INOX 316	€ 40,00
ID/01604771	1W	33 LM	4000°K	CARRÉ	Ø 30 X 26	INOX 316	€ 40,00
ID/01721424						RELAIS OBLIGATOIRE - IP44	€ 21,00

BALI

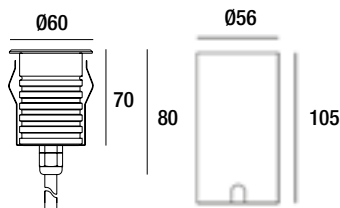

- Boîtier d'encastrement inclus
- Pré-câblé 1m H05RN-F

RÉF. ID	PUISSANCE	FLUX	T°	FORME	ENCASTREMENT MM	MATÉRIAU	PRIX HTVA
ID/02138700	2,5 W	110 LM	3000°K	ROND	Ø 55 X 105	INOX 316	€ 67,00
ID/02138699	2,5 W	110 LM	4000°K	ROND	Ø 55 X 105	INOX 316	€ 67,00
ID/02204692	2,5 W	110 LM	3000°K	CARRÉ	Ø 55 X 105	INOX 316	€ 70,00
ID/02204691	2,5 W	110 LM	4000°K	CARRÉ	Ø 55 X 105	INOX 316	€ 70,00



ENCASTRÉS DE SOL

BOMBAY

LED 3 ANS IP67 38° IRC >80 IK09 ↓ A+ 230V

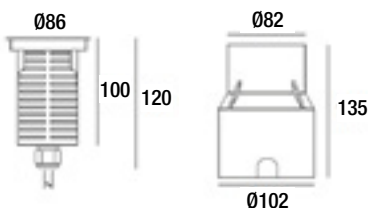

- Boîtier d'encastrement inclus
- Pré-câblé 1m H05RN-F

RÉF. ID	PUISSANCE	FLUX	T°	ENCASTREMENT MM	MATÉRIAU	PRIX HTVA
ID/02204689	7W	540 LM	3000°K	Ø 102 X 135	INOX 316	€ 104,00
ID/02204688	7W	540 LM	4000°K	Ø 102 X 135	INOX 316	€ 104,00

HYDROLED

LED 5 ANS IP67 IRC 80 IK09 ↓ A++ A 230V

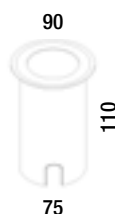
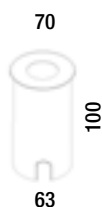

- Câble d'alimentation H05RN-F 1,5m inclus (simple presse étoupe)
- Boîtier d'encastrement inclus

RÉF. ID	PUISSANCE	FLUX	T°	ANGLE	ENCASTREMENT MM	MATÉRIAU	PRIX HTVA
ID/02122919	4W	300 LM	3000°K	25°	Ø 63 X 100	INOX 316L	€ 112,00
ID/02122921	6W	600 LM	3000°K	30°	Ø 75 X 110	INOX 316L	€ 160,00

HYDROLED ASYMÉTRIQUE

LED 5 ANS IP67 25° IRC >80 IK09 ↓ A++ A 230V

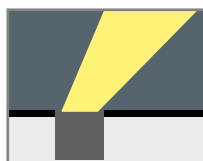
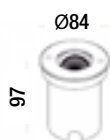

- Câble d'alimentation H05RN-F 1,5m inclus (simple presse-étoupe)
- Boîtier d'encastrement inclus

RÉF. ID	PUISSANCE	FLUX	T°	ENCASTREMENT MM	MATÉRIAU	PRIX HTVA
ID/01784723	4W	300 LM	3000°K	Ø 72 X 97	INOX 316L	€ 170,00

ENCASTRÉS DE SOL

DASAR FLAT 80

LED IP67 125° IRC >80 IK08 ↓ A++ A 230V

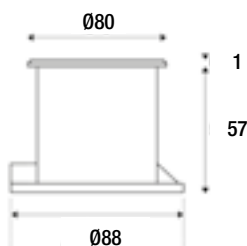

- Boîtier d'encastrement inclus

RÉF. ID	PUISSANCE	FLUX	T°	ENCASTREMENT MM	MATÉRIAU	PRIX HTVA
ID/01441628	4,3W	140 LM	3000°K	Ø 88 X 57	INOX 304/ALUMINIUM/VERRE	€ 110,00
ID/02748664	4,3W	140 LM	4000°K	Ø 88 X 57	INOX 304/ALUMINIUM/VERRE	€ 110,00

ARRAS

LED IP67 40° IRC >80 IK09 ↓ A++ A 230V

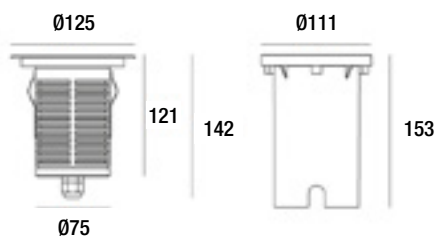

- Boîtier d'encastrement inclus
- Fixation lamelles

RÉF. ID	PUISSANCE	FLUX	T°	ENCASTREMENT MM	MATÉRIAU	PRIX HTVA
ID/03174670	11W	840 LM	3000°K	Ø 115 X 153	INOX 316/ALUMINIUM	€ 123,00
ID/03174669	11W	860 LM	4000°K	Ø 115 X 153	INOX 316/ALUMINIUM	€ 123,00
ID/02679170				BOÎTIER DE CONNEXION ÉTANCHE		€ 20,00



ENCASTRÉS DE SOL

GYRO

LED 3 ANS IP20 20° IRC 80 IK08 ↓ A++ A 230V



- Boîtier d'encastrement et 1m de câble fourni
- Convertisseur non dimmable intégré dans l'appareil

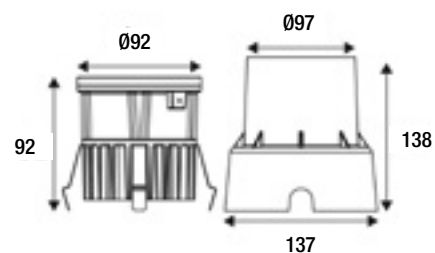

NEW

RÉF. ID	PUISSANCE	FLUX	T°	COULEUR	ENCASTREMENT MM	MATÉRIAU	PRIX HTVA
ID/03382894	6W	450 LM	3000°K	● NOIR	Ø 137 X 138	ALUMINIUM	€ 154,00
ID/03382893	6W	490 LM	4000°K	● NOIR	Ø 137 X 138	ALUMINIUM	€ 154,00

GYRO ASYMETRIQUE

LED 3 ANS IP67 IRC 80 IK08 ↓ A++ A 230V

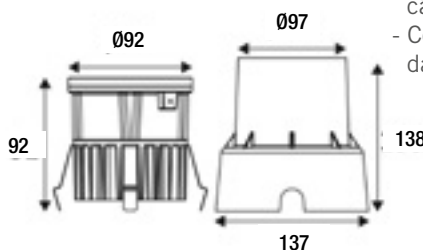

- Wall washer
- Boîtier d'encastrement et 1m de câble fourni
- Convertisseur non dimmable intégré dans l'appareil

NEW

RÉF. ID	PUISSANCE	FLUX	T°	COULEUR	ENCASTREMENT MM	MATÉRIAU	PRIX HTVA
ID/03382896	8W	180 LM	3000°K	● NOIR	Ø 137 X 138	ALUMINIUM	€ 154,00
ID/03382895	8W	155 LM	4000°K	● NOIR	Ø 137 X 138	ALUMINIUM	€ 154,00

ENCASTRÉS DE SOL

BIG APA RD-230

LED 3 ANS IP67 60° IRC 80 IK08 ↓ A++ A 230V



- Carrossable résistance 1500kg.
- Avec grille nid d'abeille
- Boîtier d'encastrement et 1m de câble fourni

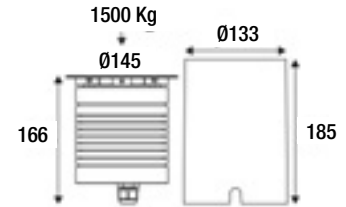

NEW

RÉF. ID	PUISSANCE	FLUX	T°	COULEUR	ENCASTREMENT MM	MATÉRIAU	PRIX HTVA
ID/03286986	20W	1436 LM	3000°K	● INOX	Ø 133 X 185	INOX 316	€ 240,00
ID/03286985	20W	1534 LM	4000°K	● INOX	Ø 133 X 185	INOX 316	€ 240,00

RODI A

LED 3 ANS IP67 IRC 80 IK10 ↓ A++ A 230V



- Wall washer
- Carrossable résistance 2000kg.
- Boîtier d'encastrement et 2.00m de câble fourni
- Convertisseur non dimmable intégré dans l'appareil

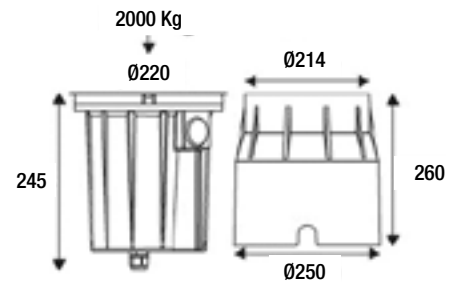

NEW

RÉF. ID	PUISSANCE	FLUX	T°	COULEUR	ENCASTREMENT MM	MATÉRIAU	PRIX HTVA
ID/03382897	20W	1610 LM	3000°K	● INOX	Ø 250 X 260	INOX 316	€ 528,00

ENCASTRÉS DE SOL

ENCASTRÉS DE SOL

KAMINO

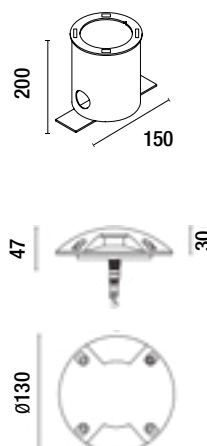
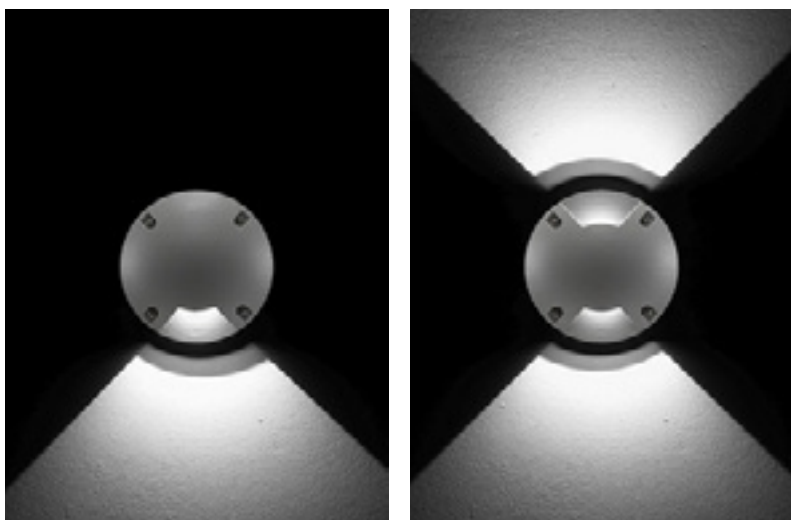

- Câble d'alimentation 25cm
- Carrossable 2000kg max.
- Peinture anti-corrosion et résistante UV

RÉF. ID	PUISSANCE	FLUX	T°	COULEUR	FAISCEAU	MATÉRIAU	PRIX HTVA
ID/01735387	1,1W	1 X 38 LM	3000°K	● ANTHRACITE	SIMPLE	ALUMINIUM	€ 231,00
ID/01735417	2,2W	2 X 38 LM	3000°K	● ANTHRACITE	DOUBLE	ALUMINIUM	€ 269,00
ID/01735943					BOITIER D'ENCASTREMENT		€ 45,00

RHO

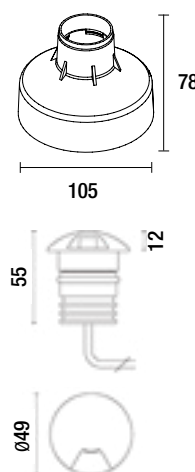
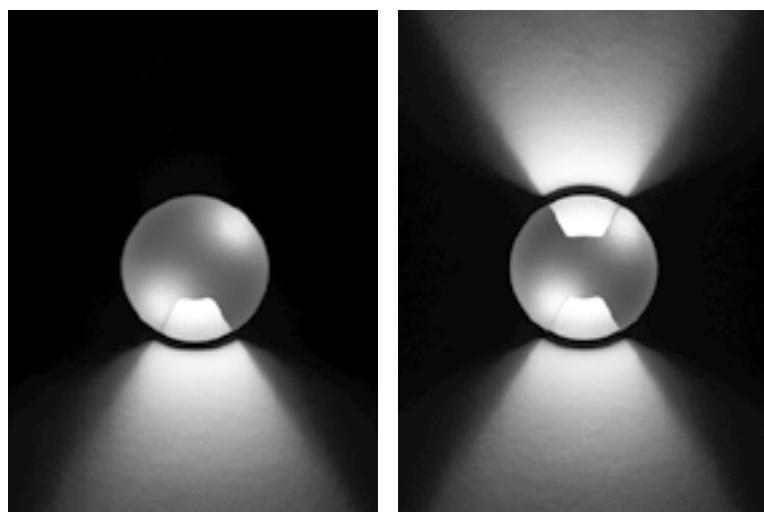

- Câble d'alimentation 25cm
- Carrossable 2000kg max
- Peinture anti-corrosion et résistante UV
- Alimentation 24 Vdc (voir p.444)

RÉF. ID	PUISSANCE	FLUX	T°	COULEUR	FAISCEAU	MATÉRIAU	PRIX HTVA
ID/02151897	1,6W	1 X 12 LM	3000°K	● ANTHRACITE	SIMPLE	INOX	€ 117,00
ID/02151900	1,6W	2 X 12 LM	3000°K	● ANTHRACITE	DOUBLE	INOX	€ 119,00
ID/01220925					BOITIER D'ENCASTREMENT		€ 6,00

BOLAS

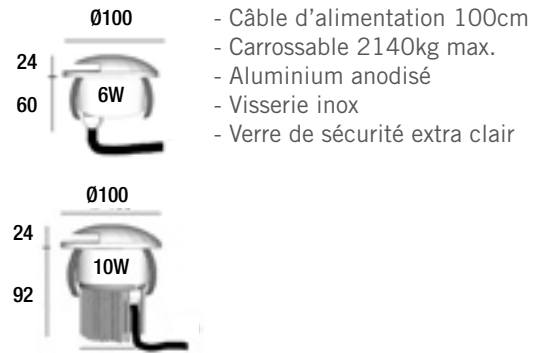

- Câble d'alimentation 100cm
- Carrossable 2140kg max.
- Aluminium anodisé
- Visserie inox
- Verre de sécurité extra clair

RÉF. ID	PUISSANCE	FLUX	T°	COULEUR	FAISCEAU	ENCASTREMENT MM	MATÉRIAU	PRIX HTVA
ID/01729980	6W	500 LM	3000°K	● ALU	SIMPLE	Ø 78 X 90	ALUMINIUM	€ 269,00
ID/02736495	10W	900 LM	3000°K	● ALU	SIMPLE	Ø 78 X 95	ALUMINIUM	€ 309,00
ID/01729950	6W	500 LM	3000°K	● ALU	DOUBLE	Ø 78 X 90	ALUMINIUM	€ 284,00
ID/02736492	10W	900 LM	3000°K	● ALU	DOUBLE	Ø 78 X 95	ALUMINIUM	€ 324,00
ID/01730010	6W	500 LM	3000°K	● ALU	QUADRUPLE	Ø 78 X 90	ALUMINIUM	€ 309,00
ID/02736498	10W	900 LM	3000°K	● ALU	QUADRUPLE	Ø 78 X 95	ALUMINIUM	€ 349,00



BORNES EXTÉRIEURES

PAGES 328 À 343

Les bornes extérieures présentent un double avantage, esthétique et fonctionnel. Elles balisent avec style terrasses et allées en prenant un peu de hauteur et peuvent s'harmoniser avec des appliques de façade pour une parfaite cohérence.



BORNES EXTÉRIEURES

- | | | | | | | | | |
|---|---|--|--|--|--|---|---|---|
| 
NINKE P
330 | 
ARROW
330 | 
COMBO
330 | 
NEW AVI
333 | 
NEW RONDO P
333 | 
NEW DINGO B
334 | 
NEW TATUM
334 | 
GOA
336 | 
BENS P
336 |
| 
TEXAS
337 | 
MIMIK
337 | 
BIDI
338 | 
PADO
339 | 
CLAIRE
340 | 
NEW TULO
340 | 
NEW TIRENO LANTERN S
341 | 
NEW TIRENO LANTERN P
341 | 
NEW PARA
342 |
| 
NEW KALA
342 | 
NEW RAMA
343 | 
NEW KALKI
343 | | | | | | |

BORNES EXTÉRIEURES

NINKE P



230V

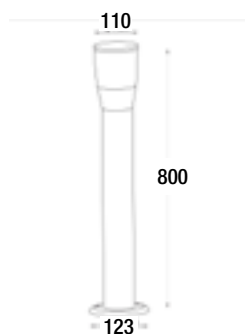

NEW

RÉF. ID	CULOT	PUISSANCE MAX	FLUX MAX	COULEUR	MATÉRIAU	PRIX HTVA
ID/02612014	GU10	MAX 9W	575 LM	● NOIR	ALUMINIUM	€ 51,00

Disponible en applique extérieure page 378

ARROW

LED

5 ANS



IRC 80



230V



- Corps en aluminium et diffuseur en polycarbonate



RÉF. ID	PUISSANCE	FLUX	T°	COULEUR	MATÉRIAU	PRIX HTVA
ID/02257631	5,5W	665 LM	3000°K	● ANTHRACITE	ALUMINIUM	€ 90,00

COMBO

LED

5 ANS



230V



Ø90



RÉF. ID	PUISSANCE	FLUX	T°	COULEUR	DIMENSIONS MM	MATÉRIAU	PRIX HTVA
ID/01732568	7W	200 LM	3000°K	● NOIR	250 X 90	ALUMINIUM	€ 79,00
ID/01732569	7W	200 LM	3000°K	● NOIR	450 X 90	ALUMINIUM	€ 90,00
ID/01732570	7W	200 LM	3000°K	● NOIR	650 X 90	ALUMINIUM	€ 116,00





BORNES EXTÉRIEURES

AVI

LED 3 ANS IP44 IRC 80 A++ A 230V

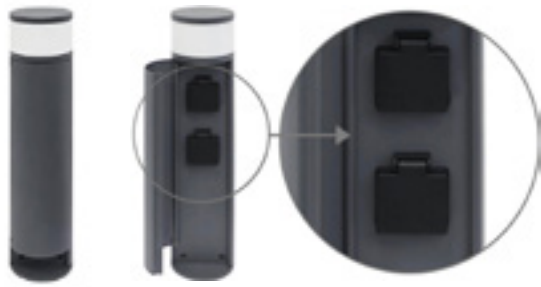

- Borne avec prises 2P + T 16A max. 2x2000W.

NEW

RÉF. ID	PUISSANCE	FLUX	T°	COULEUR	MATÉRIAU	PRIX HTVA
ID/03286990	3W	650 LM	4000°K	● ANTHRACITE	FORGE D ALUMINIUM	€ 169,00

RONDO P

3 ANS IP54 A++ A 230V



Le conseil de l'éclairagiste:

Un verre opalin maximisera l'uniformité de la diffusion lumineuse tout en minimisant les effets d'éblouissement. Le verre transparent fera la part belle à l'esthétique de l'ampoule; tout comme le verre fumé qui lui apportera en plus une touche plus intimiste.

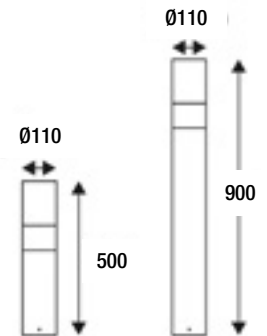

NEW

RÉF. ID	CULOT	PUISSANCE MAX	COULEUR	DIMENSIONS MM	MATÉRIAU	PRIX HTVA
ID/03286977	E27	MAX 9W	● VERRE CLAIR	Ø 110 X 500	ALUMINIUM	€ 125,00
ID/03286979	E27	MAX 9W	● VERRE FUME	Ø 110 X 500	ALUMINIUM	€ 125,00
ID/03286975	E27	MAX 9W	○ VERRE OPALIN	Ø 110 X 500	ALUMINIUM	€ 125,00
ID/03286978	E27	MAX 9W	● VERRE CLAIR	Ø 110 X 900	ALUMINIUM	€ 166,00
ID/03286980	E27	MAX 9W	● VERRE FUME	Ø 110 X 900	ALUMINIUM	€ 166,00
ID/03286976	E27	MAX 9W	○ VERRE OPALIN	Ø 110 X 900	ALUMINIUM	€ 166,00

Disponible en applique extérieure page 378

BORNES EXTÉRIEURES

BORNES EXTÉRIEURES

DINGO B

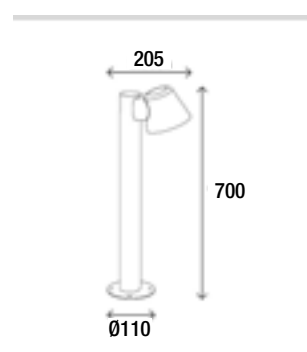

NEW

RÉF. ID	CULOT	PUISSANCE	FLUX	T°	COULEUR	MATÉRIAU	PRIX HTVA
ID/02612007	GU10	4,5W	320 LM	3000°K	○ BLANC	ALUMINIUM	€ 52,00
ID/02612006	GU10	4,5W	320 LM	3000°K	● NOIR	ALUMINIUM	€ 52,00

Disponible en applique extérieure page 381

TATUM

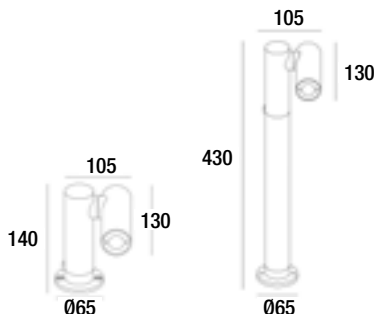

NEW

RÉF. ID	PUISSANCE	FLUX	T°	COULEUR	HAUTEUR MM	MATÉRIAU	PRIX HTVA
ID/02773203	4,5W	417 LM	3000°K	● ANTHRACITE	140	ALUMINIUM	€ 63,00
ID/02773205	4,5W	417 LM	3000°K	● ANTHRACITE	430	ALUMINIUM	€ 83,00

Disponible en spot à piquer page 352



BORNES EXTÉRIEURES

GOA

LED 3 ANS IP65    230V 

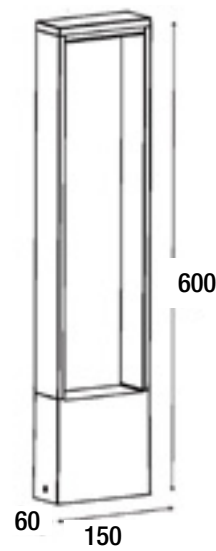

RÉF. ID	PUISSANCE	FLUX	T°	COULEUR	PRIX HTVA
ID/03170158	6,5W	350 LM	3000°K	● ANTHRACITE	€ 132,00

Disponible en applique extérieure page 306

BENS P

LED 3 ANS IP54 120° IRC >80 IK08    230V 

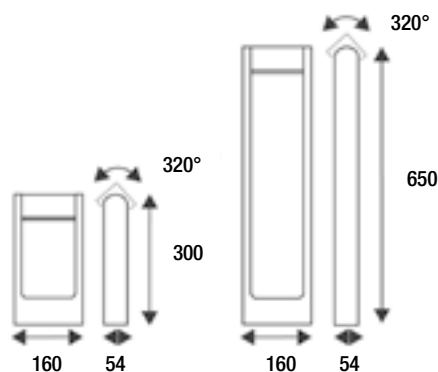

RÉF. ID	PUISSANCE	FLUX	T°	COULEUR	HAUTEUR MM	PRIX HTVA
ID/03126802	6W	600 LM	3000°K	● ANTHRACITE	300	€ 125,00
ID/03126803	6W	600 LM	3000°K	● ANTHRACITE	650	€ 149,00



BORNES EXTÉRIEURES

TEXAS

LED 5 ANS IP54 A++ A 230V

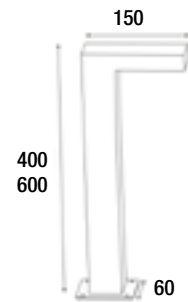

RÉF. ID	PUISSANCE	FLUX	T°	COULEUR	HAUTEUR MM	PRIX HTVA
ID/00817099	6W	230 LM	3000°K	● ANTHRACITE	400	€ 99,00
ID/00817100	6W	230 LM	3000°K	● ANTHRACITE	600	€ 116,00

Disponible en applique extérieure page 366
Disponible avec détecteur page 300

MIMIK

LED IP65 IRC 70 IK08 A++ A 230V

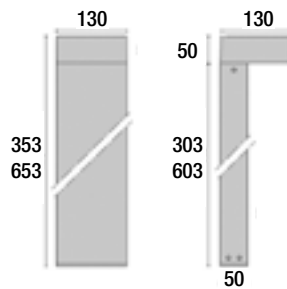

- Corps aluminium
- Diffuseur en verre trempé
- Joint en silicone
- Diffusion asymétrique
- Vis de blocage en acier inoxydable
- Plaque de base incluse
- Peinture résistante UV

RÉF. ID	PUISSANCE	FLUX	T°	COULEUR	HAUTEUR MM	PRIX HTVA
ID/02257521	11W	745 LM	3000°K	● ANTHRACITE	353	€ 198,00
ID/02257522	11W	915 LM	4000°K	● ANTHRACITE	353	€ 198,00
ID/02257523	11W	745 LM	3000°K	● ANTHRACITE	653	€ 205,00
ID/02257524	11W	915 LM	4000°K	● ANTHRACITE	653	€ 205,00



BORNES EXTÉRIEURES

BIDI

LED 5 ANS IP66 IRC 85 A++ A 230V

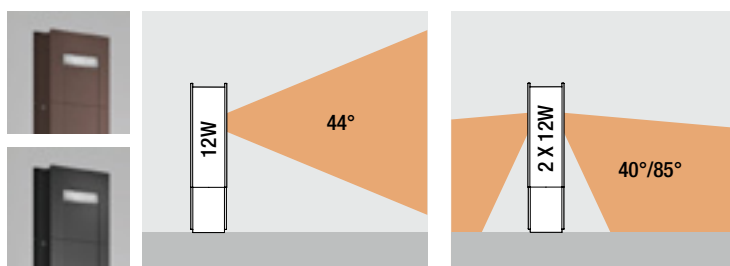
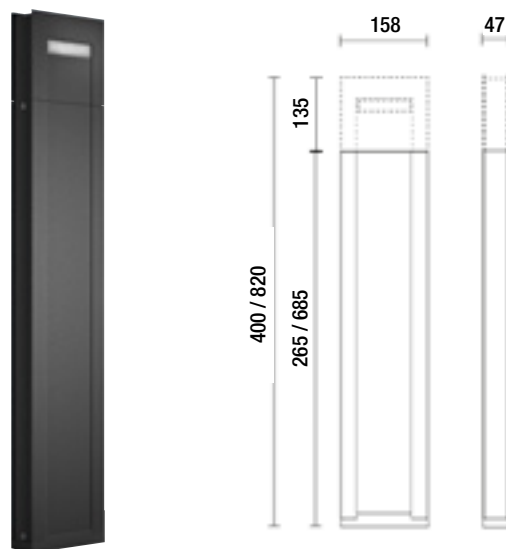

NEW

RÉF. ID	PUISSANCE	FLUX	T°	COULEUR	DIMENSIONS MM	PRIX HTVA
ID/02232984	12W	1271 LM	3000°K	● NOIR	158 X 47 X 135	€ 226,00
ID/02232985	12W	1271 LM	3000°K	● ROUILLE	158 X 47 X 135	€ 226,00
ID/02232986	2 X 12W	2 X 1271 LM	3000°K	● NOIR	158 X 47 X 135	€ 264,00
ID/02232988	2 X 12W	2 X 1271 LM	3000°K	● ROUILLE	158 X 47 X 135	€ 264,00

BORNES EXTÉRIEURES



RÉF. ID	ACCESSOIRES	COULEUR	DIMENSIONS MM	PRIX HTVA
ID/02232982	MAT 685 MM	● NOIR	158 X 47 X 685	€ 81,00
ID/02232983	MAT 685 MM	● ROUILLE	158 X 47 X 685	€ 81,00

ATTENTION ! IL EST IMPÉRATIF DE COMMANDER LES 2 PARTIES DU SYSTÈME TÊTE + MAT

Disponible en applique page 368

BORNES EXTÉRIEURES

PADO

LED IP65 IRC 80    230V 

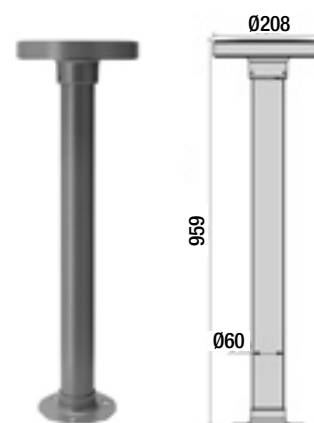
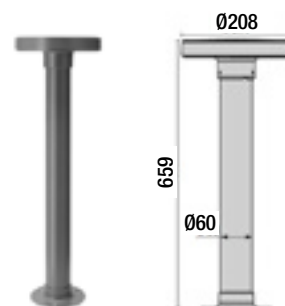

BORNES EXTÉRIEURES



RÉF. ID	PUISSANCE	FLUX	T°	COULEUR	HAUTEUR MM	PRIX HTVA
ID/02092747	20W	1974 LM	3000°K	● ANTHRACITE	659	€ 179,00
ID/02092751	20W	1974 LM	3000°K	● ANTHRACITE	959	€ 189,00

BORNES EXTÉRIEURES

CLAIRE

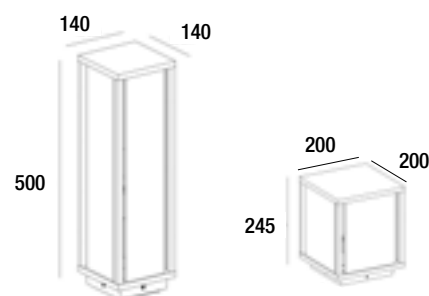
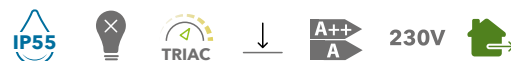

RÉF. ID	CULOT	PUISSANCE MAX	FLUX MAX	COULEUR	DIMENSIONS MM	MATÉRIAU	PRIX HTVA
ID/02509836	E27	MAX 9W	800 LM	● NOIR	200 X 200 X 245	ALUMINIUM	€ 124,00
ID/02509837	E27	MAX 9W	800 LM	● NOIR	140 X 140 X 500	ALUMINIUM	€ 137,00

Disponible en applique extérieure page 374

TULO

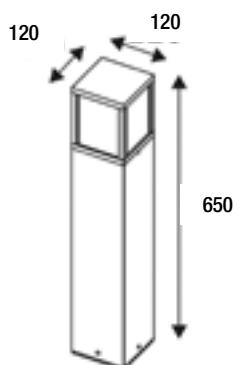

- Diffuseur en verre clair



NEW

RÉF. ID	CULOT	PUISSANCE MAX	FLUX MAX	COULEUR	MATÉRIAU	PRIX HTVA
ID/03286989	E27	MAX 9W	800 LM	● ANTHRACITE	ALUMINIUM	€ 149,00

Disponible avec détecteur page 301

BORNES EXTÉRIEURES

TIRENO LANTERN S



230V



NEW

RÉF. ID	CULOT	PUISSANCE MAX	FLUX MAX	COULEUR	MATÉRIAU	PRIX HTVA
ID/00546838	E27	MAX 9W	800 LM	● NOIR	ALUMINIUM	€ 28,00

Disponible en applique extérieure page 379

TIRENO LANTERN P



230V



NEW

RÉF. ID	CULOT	PUISSANCE MAX	FLUX MAX	COULEUR	DIMENSIONS MM	MATÉRIAU	PRIX HTVA
ID/00546841	E27	MAX 9W	800 LM	● NOIR	1 200 X 165 X 165	ALUMINIUM	€ 40,00
ID/00546844	3 X E27	MAX 3 X 9W	3 X 800 LM	● NOIR	2 020 X 515 X 515	ALUMINIUM	€ 240,00

BORNES EXTÉRIEURES



BORNES SOLAIRES

PARA

LED 3 ANS IP54 15° IRC 80

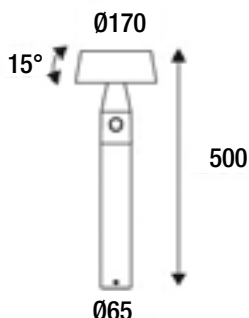

- Borne avec cellules solaires et batterie rechargeable
- Fonctionne uniquement quand la luminosité est inférieure à 20 Lux
- Détecteur IR 120°, distance de détection max. 6m.
- Trois modes ON (100% de luminosité pendant 6 heures sans détection), DIM (20% de luminosité pendant 4 heures, quand un mouvement est détecté, le luminaire passe à 100% de luminosité pendant 15 secondes puis à 20% de luminosité) et AUTO (lorsqu'un mouvement est détecté le luminaire s'allume à 100% de luminosité pendant 15 secondes puis s'éteint)
- Temps de charge 8 heures en plein ensoleillement.
- Piquet à enterrer inclus

NEW

RÉF. ID	PUISSANCE	FLUX	T°	COULEUR	MATÉRIAU	PRIX HTVA
ID/03382903	1W	110 LM	3000°K	● ANTHRACITE	ALUMINIUM	€ 145,00

KALA

LED 3 ANS IP54 IRC 80

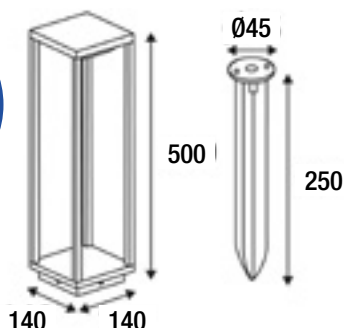

- Borne avec cellules solaires et batterie rechargeable.
- Fonctionne uniquement quand la luminosité est inférieure à 20 Lux
- Avec interrupteur et détecteur IR 120°, rayon de détection max. 6m
- Deux niveaux d'éclairage après détection, 225 lumens pendant 45 secondes puis 35 lumens avec une autonomie de 15 heures
- Temps de charge 6 à 8 heures en plein ensoleillement.
- Piquet à enterrer inclus

BORNES EXTÉRIEURES

NEW

RÉF. ID	PUISSANCE	FLUX	T°	COULEUR	MATÉRIAU	PRIX HTVA
ID/02682410	2W	230 LM	4000°K	● ANTHRACITE	ALUMINIUM	€ 150,00

Le conseil de l'éclairagiste:

Quand il n'est pas possible d'amener une ligne d'alimentation là où vous souhaitez de l'éclairage, les bornes solaires représentent une alternative intéressante avec une consommation électrique nulle.

RAMA

LED 3 ANS IP54 IRC 80

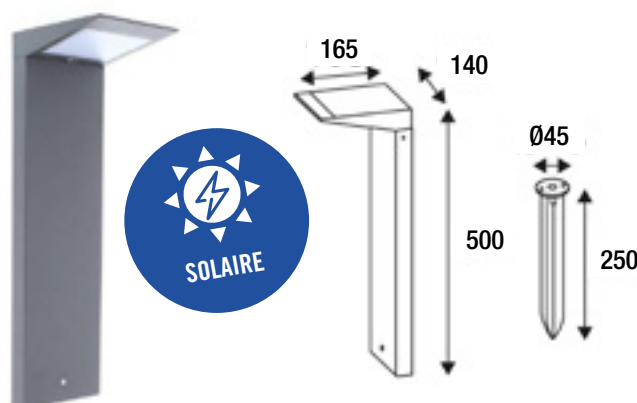

- Borne avec cellules solaires et batterie rechargeable.
- Fonctionne uniquement quand la luminosité est inférieure à 20 Lux
- Avec interrupteur et détecteur HF 180°, distance de détection max. 6m
- Deux niveaux d'éclairage après détection, 140 lumens pendant 30 secondes puis 20 lumens avec une autonomie de 15 heures.
- Temps de charge 6 à 8 heures en plein ensoleillement
- Piquet à enterrer inclus

NEW

RÉF. ID	PUISSANCE	FLUX	T°	COULEUR	MATÉRIAU	PRIX HTVA
ID/02786401	2W	600 LM	4000°K	● ANTHRACITE	ALUMINIUM	€ 130,00

KALKI

LED 3 ANS IP54 75° IRC 80

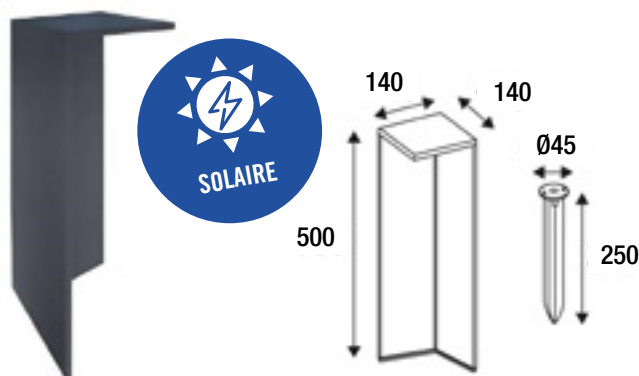

- Borne avec cellules solaires et batterie rechargeable.
- Fonctionne uniquement quand la luminosité est inférieure à 20 Lux
- Avec interrupteur et détecteur HF 120°, distance de détection max. 6m
- Deux niveaux d'éclairage après détection, 250 lumens pendant 30 secondes puis 40 lumens avec une autonomie de 15 heures
- Temps de charge 6 à 8 heures en plein ensoleillement
- Piquet à enterrer inclus

NEW

RÉF. ID	CULOT	PUISSANCE	FLUX	T°	COULEUR	MATÉRIAU	PRIX HTVA
ID/02786402	LED	2W	250 LM	4000°K	● ANTHRACITE	ALUMINIUM	€ 160,00

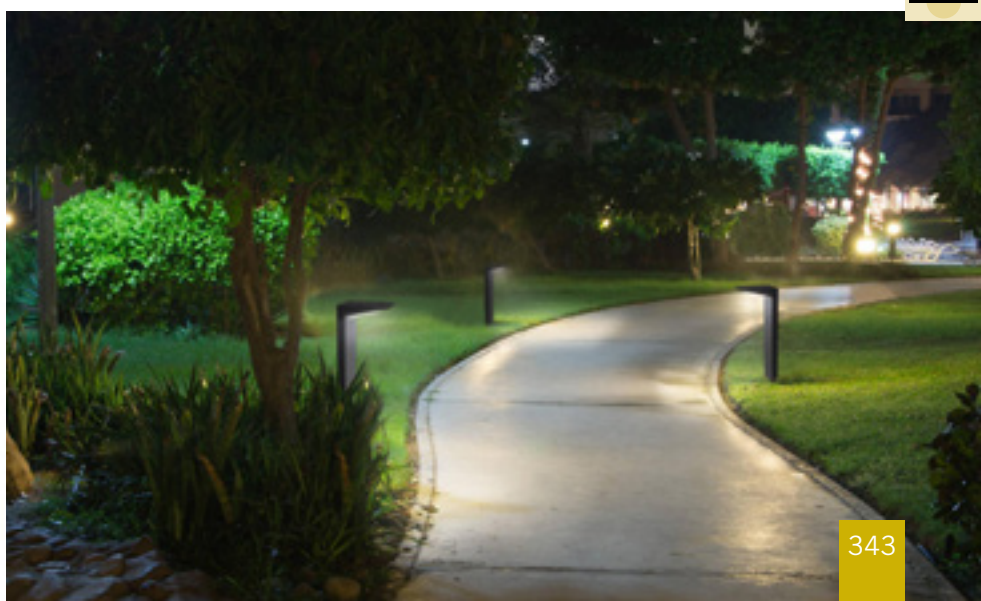

SPOTS À PIQUER & ACCESSOIRES

PAGES 344 À 355

Avec une grande facilité d'installation et une mobilité permettant les changements et ajustements (par exemple: en fonction de l'évolution de la végétation), les spots à piquer sont une solution pratique et à budget contenu pour mettre en valeur divers éléments de vos extérieurs.



SPOTS À PIQUER & ACCESSOIRES



PIKI
346



KOBI
346



NAUTILUS
346



NEW

SPIKE
347



SYNA
348



NEW

MANAL
348



SNAKE
349



LEVANTO
349



INTRO MINI
350



INTRO MIDI
350



INTRO MAXI
351



MINIMAL
352



NEW

TATUM
352



NEW

JUNCUS
353



NEW

POWERPOINT
353



T6 GARDEN
354

SPOTS À PIQUER & ACCESSOIRES

PIKI

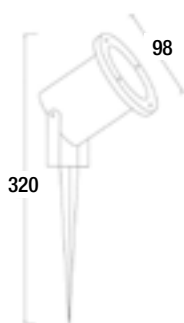

RÉF. ID	CULOT	PUISSANCE MAX	FLUX MAX	COULEUR	MATÉRIAU	PRIX HTVA
ID/02877866	GU10	9W	575 LM	● GRAPHITE	ALUMINIUM	€ 25,00

KOBI

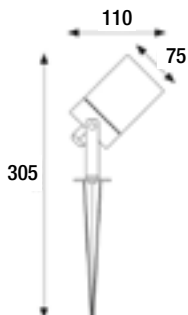

RÉF. ID	CULOT	PUISSANCE MAX	FLUX MAX	COULEUR	MATÉRIAU	PRIX HTVA
ID/02878664	GU10	9W	575 LM	● NOIR	ALUMINIUM	€ 35,00

NAUTILUS

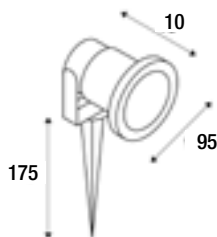

RÉF. ID	CULOT	PUISSANCE MAX	FLUX MAX	COULEUR	LONGUEUR DU CÂBLE MM	MATÉRIAU	PRIX HTVA
ID/01057410	GU10	9W	575 LM	● ARGENT	1500	ALUMINIUM	€ 30,00
ID/01057409	GU10	9W	575 LM	● NOIR	1500	ALUMINIUM	€ 35,00
ID/02748499	GU10	9W	575 LM	● ROUILLE	1500	ALUMINIUM	€ 35,00
ID/02748500	GU10	9W	575 LM	● VERT	1500	ALUMINIUM	€ 35,00

SPOTS À PIQUER & ACCESSOIRES

SPIKE

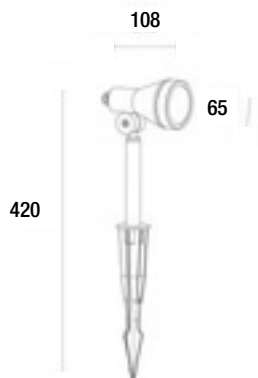

NEW

RÉF. ID	CULOT	PUISSANCE	FLUX	T°	COULEUR	LONGUEUR DU CÂBLE MM	MATÉRIAU	PRIX HTVA
ID/02325462	GU10	5W	320 LM	3000°K	● NOIR	2100	MÉTAL	€ 39,00



SPOTS À PIQUER ET ACCESSOIRES



Le conseil de l'éclairagiste:

Les spots à piquer équipés d'une lampe GU10 ont l'avantage de laisser le choix de la couleur de lumière, de la puissance, de la largeur du faisceau... mais présentent l'inconvénient d'une durée de vie réduite de la source due à sa présence dans un luminaire complètement fermé.

SPOTS À PIQUER & ACCESSOIRES

SYNA

LED IP65 50° IRC >80 ↓ 230V

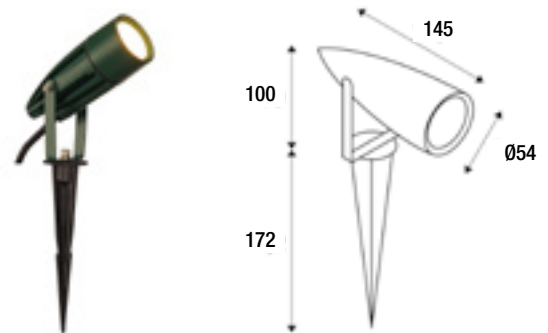

RÉF. ID	PUISSANCE	FLUX	T°	COULEUR	LONGUEUR DU CABLE MM	MATÉRIAU	PRIX HTVA
ID/02271939	8,6W	470 LM	3000°K	● ANTHRACITE	1500	ALUMINIUM	€ 70,00
ID/02271938	8,6W	470 LM	3000°K	● ARGENT	1500	ALUMINIUM	€ 70,00
ID/02271940	8,6W	470 LM	3000°K	● ROUILLE	1500	ALUMINIUM	€ 70,00
ID/02271941	8,6W	470 LM	3000°K	● VERT	1500	ALUMINIUM	€ 70,00

MANAL

LED 3 ANS IP65 110° 40° IRC 80 ↓ A++ A 230V

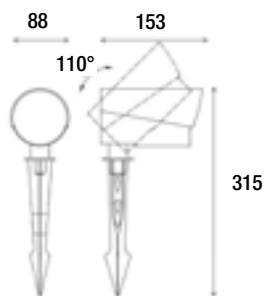

NEW

RÉF. ID	PUISSANCE	FLUX	T°	COULEUR	LONGUEUR DU CABLE MM	MATÉRIAU	PRIX HTVA
ID/02773207	12W	988 LM	3000°K	● ANTHRACITE	400	ALUMINIUM	€ 91,00

SPOTS À PIQUER & ACCESSOIRES

SNAKE

LED 5 ANS IP65 120° 24° IRC 80 A++ A 230V

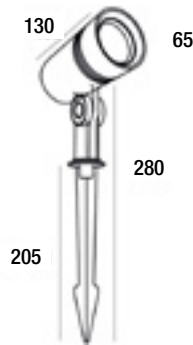

- Grille nid d'abeille inclus
- Piquet inclus
- câble H05RNF : 3 x 0,75 mm² (1 mètre)

NEW

RÉF. ID	PUISSANCE	FLUX	T°	COULEUR	LONGUEUR DU CÂBLE MM	MATÉRIAU	PRIX HTVA
ID/03546923	10W	900 LM	3000°K	● NOIR	1000	ALUMINIUM	€ 62,00

LEVANTO

LED 5 ANS IP66 90° A++ A 230V

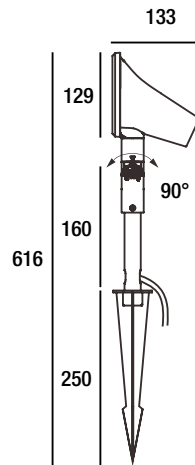

- Éclairage asymétrique 130° x 50°

NEW

RÉF. ID	PUISSANCE	FLUX	T°	COULEUR	MATÉRIAU	PRIX HTVA
ID/03546876	15W	1880 LM	3000°K	● NOIR	ALUMINIUM/INOX	€ 152,00
ID/03546877	15W	1950 LM	4000°K	● NOIR	ALUMINIUM/INOX	€ 152,00

Disponible en projecteur page 417

Le conseil de l'éclairagiste:

Les spots à piquer équipés d'une source LED intégrée d'usine ont l'avantage de présenter une bien meilleure durabilité/fiabilité de leur source lumineuse dans le temps par rapport à un spot équipé d'une source GU10.



SPOTS À PIQUER & ACCESSOIRES

INTRO MINI

LED 5 ANS IP67 IRC >80 TRIAC ↓ 230V

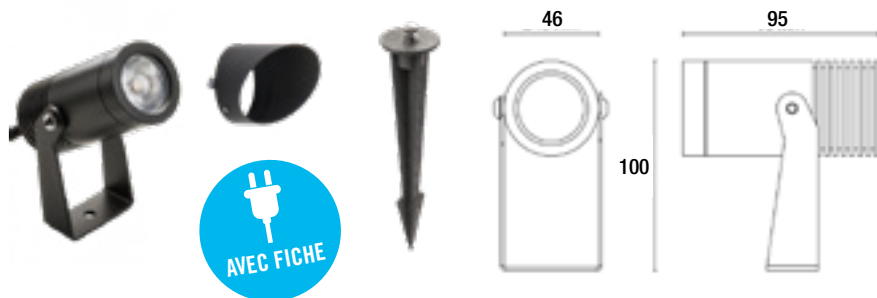

- Diffuseur: verre clair trempé
- Plug and play, fourni avec câble H07 RNF 3x1,5mm² et fiche électrique



RÉF. ID	PUISSANCE	FLUX	T°	FAISCEAU	MATÉRIAU	PRIX HTVA
ID/02870412	8W	540 LM	3000°K	15°	ALUMINIUM	€ 110,00
ID/02870413	8W	540 LM	3000°K	36°	ALUMINIUM	€ 110,00
ID/02870414	8W	540 LM	4000°K	15°	ALUMINIUM	€ 110,00
ID/02870415	8W	540 LM	4000°K	36°	ALUMINIUM	€ 110,00
ID/02870416			VISIÈRE			€ 8,00
ID/02870401			PIQUET			€ 8,00

INTRO MIDI

LED 5 ANS IP67 IRC >80 TRIAC ↓ 230V



- Diffuseur: verre clair trempé
- Plug and play, fourni avec câble H07 RNF 3x1,5mm² et fiche électrique



RÉF. ID	PUISSANCE	FLUX	T°	FAISCEAU	MATÉRIAU	PRIX HTVA
ID/02870407	12W	1060 LM	3000°K	15°	ALUMINIUM	€ 152,00
ID/02870408	12W	1060 LM	3000°K	36°	ALUMINIUM	€ 152,00
ID/02870409	12W	1060 LM	4000°K	15°	ALUMINIUM	€ 152,00
ID/02870410	12W	1060 LM	4000°K	36°	ALUMINIUM	€ 152,00
ID/02870411			VISIÈRE			€ 10,00
ID/02870401			PIQUET			€ 8,00

SPOTS À PIQUER ET ACCESSOIRES

SPOTS À PIQUER & ACCESSOIRES

INTRO MAXI

LED 5 ANS IP67 IRC >80 TRIAC ↓ 230V 



- Diffuseur: verre clair trempé
- Plug and play, fourni avec câble H07 RNF 3x1,5mm² et fiche électrique

RÉF. ID	PUISSANCE	FLUX	T°	FAISCEAU	MATÉRIAU	PRIX HTVA
ID/02870402	23W	2010 LM	3000°K	15°	ALUMINIUM	€ 237,00
ID/02870403	23W	2010 LM	3000°K	36°	ALUMINIUM	€ 237,00
ID/02870404	23W	2010 LM	4000°K	15°	ALUMINIUM	€ 237,00
ID/02870405	23W	2010 LM	4000°K	36°	ALUMINIUM	€ 237,00
ID/02870406			VISIÈRE			€ 18,00
ID/02870401			PIQUET			€ 8,00



SPOTS À PIQUER & ACCESSOIRES

MINIMAL

LED 5 ANS IP65 68° IRC 80 ↓ 230V

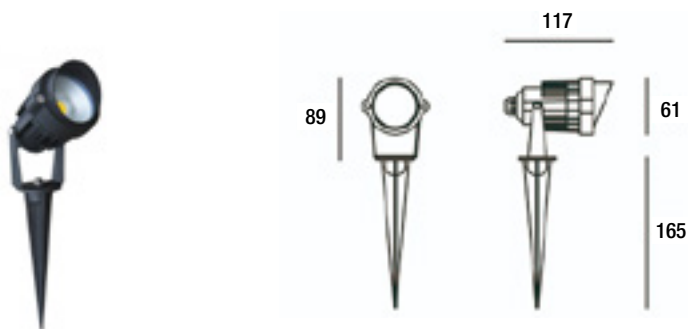

RÉF. ID	PUISSANCE	FLUX	T°	COULEUR	MATÉRIAU	PRIX HTVA
ID/02257528	5,7W	271 LM	3000°K	● NOIR	ALUMINIUM	€ 50,00

TATUM

LED 3 ANS IP65 300° 30° IRC 80 ↓ A++ A 230V



NEW

RÉF. ID	PUISSANCE	FLUX	T°	COULEUR	DIMENSIONS MM	TYPE	MATÉRIAU	PRIX HTVA
ID/02773203	4,5W	417 LM	3000°K	● ANTHRACITE	130 X 140 X 105	SANS PIQUET	ALUMINIUM	€ 63,00
ID/02773204	4,5W	417 LM	3000°K	● ANTHRACITE	395 X 90 X 120	AVEC PIQUET	ALUMINIUM	€ 70,00

Disponible en borne page 334

SPOTS À PIQUER & ACCESSOIRES

JUNCUS

LED 5 ANS IP65 360° 30° IRC 80 A++ A 230V



- Système de zoom permettant d'ajuster l'angle du faisceau sans outil
- Possibilité de modifier facilement la hauteur totale par vissage de cannes

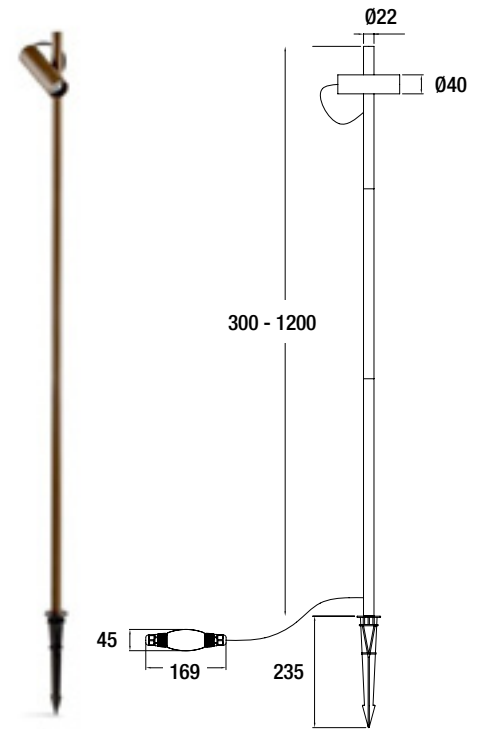

NEW

RÉF. ID	PUISSANCE	FLUX	T°	COULEUR	LONGUEUR DU CABLE MM	MATÉRIAU	PRIX HTVA
ID/02614464	6,4W	418 LM	3000°K	● MARRON	1500	ALUMINIUM/POLYCARBONATE	€ 165,00

POWERPOINT

3 ANS IP44 ↓ 230V



- Colonne à double fiche étanches aux éclaboussures

Le conseil de l'éclairagiste:

Une solution pratique et élégante pour de multiples connexions extérieures (luminaires sur prise, outils électriques de jardinage...).

NEW

RÉF. ID	PUISSANCE MAX	COULEUR	LONGUEUR DU CABLE MM	MATÉRIAU	PRIX HTVA
ID/03468777	2X 2000W	● ANTHRACITE	150	ALUMINIUM	€ 83,00

SPOTS À PIQUER ET ACCESSOIRES



SPOTS À PIQUER & ACCESSOIRES

T6 GARDEN



Le T6 Garden est un récepteur avec 6 canaux commandés individuellement par une télécommande sans fil ou via une application pour smartphone et une connexion Wi-Fi.

Le T6 Garden permet de commander tout circuit électrique à l'extérieur comme celui de l'éclairage, de l'arrosage, de la pompe, de la fontaine, du chauffage IR...

Avec ce kit T6 Garden, vous pourrez programmer facilement différents scénarios en fonction de la météo, du lever et du coucher du soleil, de la localisation... Bref, vous gérez avec simplicité et modularité l'ensemble de vos circuits extérieurs.

- Alimentation 230 V 50 Hz
- Fréquence de réception : 433 MHz
- Récepteur Wi-Fi intégré (app Tuya)
- 6 NO libres de potentiel 4 x 10 A et 2 x 16 A
- Commande LED jusqu'à 300 W par sortie de 10 A et 500 W par sortie de 16 A
- Largeur 7 modules, I 125 x H 80 x P 33 mm
- IP20, IP66 dans le boîtier OBO fermé
- Bornier à vis, connecteurs rapides fournis
- Enclenchement manuel sur le récepteur et visualisation de l'état du relais
- ON/OFF bistable
- Fonction ON/OFF général avec télécommande
- Température admissible : -10 à + 55 °C

RÉF. ID	DESCRIPTION	PRIX HTVA
ID/03468767	T6 GARDEN	€ 203,00





ÉCLAIRAGE



ARROSAGE



FONTAINE



CHAUFFAGE RADIANT



ET BIEN PLUS...

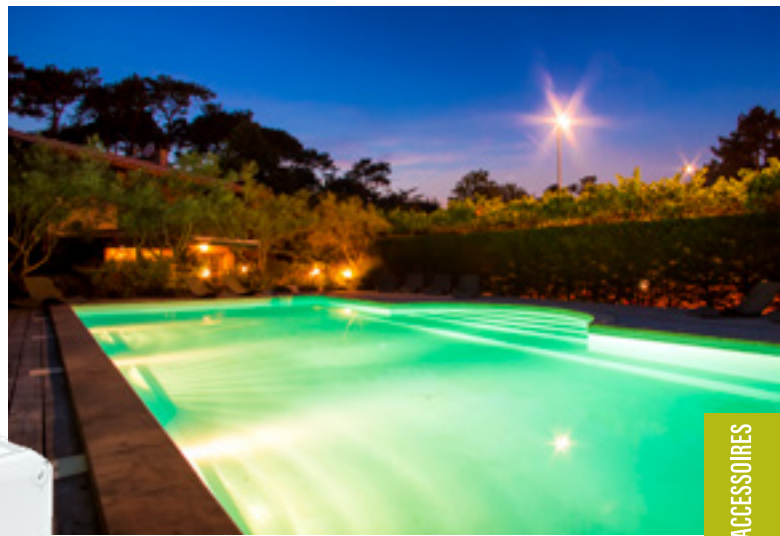

RF 433 MHz

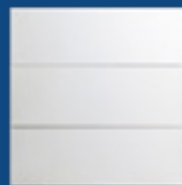

SPOTS À PIQUER ET ACCESSOIRES



CONFIGUREZ ET COMMANDEZ VOTRE T6 GARDEN DEPUIS VOTRE SMARTPHONE

Exemples de possibilités avec l'application Tuya Smart :

- ON/OFF sur tous les canaux
- programmation horaire
- renommer votre T6 Garden et/ou les interrupteurs
- création de scénarios en fonction de la météo (vitesse du vent, humidité, obscurité), du lever et du coucher du soleil, de la localisation, etc.
- mémorisation de nouveaux interrupteurs



APPLIQUES EXTÉRIEURES

PAGES 356 À 395

Grâce aux appliques extérieures, vous illuminez et dynamisez vos façades; vous apportez un éclairage discret ou puissant à votre porte d'entrée, à votre terrasse ou à votre jardin.



APPLIQUES EXTÉRIEURES

				 NEW	 NEW			
AVORIAZ 358	AVORIAZ DOUBLE 358	ECHO 358	ECHO DOUBLE 359	ZORA-LED 359	ZORA-LED DOUBLE 359	METRO 360	METRO DOUBLE 360	COSMOS 361
					 NEW	 NEW	 NEW	 NEW
COSMOS DOUBLE 361	QUASAR 10 362	QUASAR 20 362	QUASAR 30 363	HOCKENHEIM 364	REX 2 364	NUALA 365	BELFAST 366	GOA 366
 NEW			 NEW	 NEW	 NEW	 NEW		 NEW
TEXAS 366	BIDI APPLIQUE 368	WALL WASHER 369	POLO+ ZERO 370	POLO+ 1 370	POLO+ 2 371	POLO+ 3 371	SLAT 372	SLAT ONE 373
		 NEW	 NEW			 NEW	 NEW	 NEW
CLAIRE 374	BRICK 375	YELI 376	SINGA 377	NERES 377	DUKAN 377	RONDO WALL 378	NINKE WALL 378	TIRENO WALL 379
 NEW	 NEW	 NEW	 NEW	 NEW	 NEW	 NEW	 NEW	 NEW
DUDLEY DOWN 380	DUDLEY OVAL 380	DUDLEY ROUND 381	DINGO 381	YIKA 382	WIDO 382	THESI 383	CADRA 383	WALL 384
		 NEW					 NEW	
CURIE 384	SERENATE 385	APRIL 385	SPIKE SIMPLE 387	SPIKE DOUBLE 387	SPIKE DOUBLE + 2 PRISES 387	GEOLED 388	NEW FLASH 388	GEOLED 389
								
RHINO 389	COLOGNE 390	FRAME MINI 391	FRAME ROUND 392	FRAME SQUARE 392	FRAME ROUND WALL 393	FRAME SQUARE WALL 393	COLOGNE MINI 394	CALLISTO WALL 394
 NEW								
DOME 395	ITO 395							

APPLIQUES EXTÉRIEURES

AVORIAZ

3 ANS

IP65



IK06

TRIAC



A+



230V

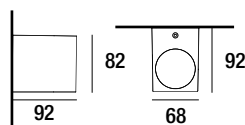

Le conseil de l'éclairagiste:

Une applique "down" procure un éclairage idéal à côté d'une porte d'entrée par exemple ainsi que sur des bâtiments avec des arrivées électrique situées à proximité de la corniche du toit.

RÉF. ID	CULOT	PUISSANCE MAX	FLUX MAX	COULEUR	MATÉRIAU	PRIX HTVA
ID/02628628	GU10	MAX 5W	575 LM	● NOIR	ALUMINIUM	€ 42,00
ID/02628627	GU10	MAX 5W	575 LM	● ANTHRACITE	ALUMINIUM	€ 42,00

AVORIAZ DOUBLE

3 ANS

IP65



IK06

TRIAC



A+



230V

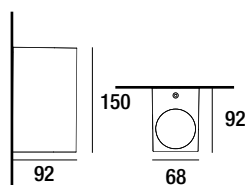

Le conseil de l'éclairagiste:

Choisir des appliques "up&down" pour vos façades extérieures, c'est choisir de les mettre en valeur avec rythme, tout en soulignant la verticalité du bâtiment.

RÉF. ID	CULOT	PUISSANCE MAX	FLUX MAX	COULEUR	MATÉRIAU	PRIX HTVA
ID/02628630	2 X GU10	2 X MAX 5W	2 X 575 LM	● NOIR	ALUMINIUM	€ 50,00
ID/02628629	2 X GU10	2 X MAX 5W	2 X 575 LM	● ANTHRACITE	ALUMINIUM	€ 50,00

ECHO

5 ANS

IP54



TRIAC



A++
A



230V



ANTI CORROSION GARANTIE 10 ANS

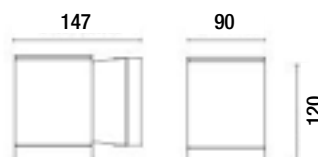

- Accès à la source lumineuse par ouverture magnétique

RÉF. ID	CULOT	PUISSANCE MAX	FLUX MAX	COULEUR	MATÉRIAU	PRIX HTVA
ID/00776440	GU10	MAX 5W	575 LM	● NOIR	ALUMINIUM	€ 85,00
ID/00776503	GU10	MAX 5W	575 LM	● GRAPHITE	ALUMINIUM	€ 85,00

Disponible en plafonnier extérieur page 398

APPLIQUES EXTÉRIEURES

ECHO DOUBLE

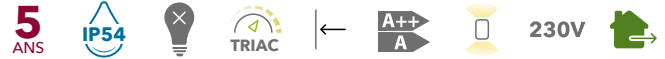

ANTI
CORROSION
GARANTIE
10 ANS

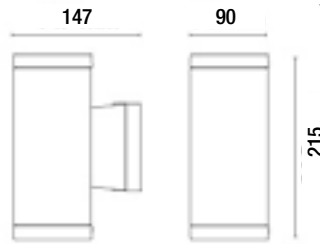

- Accès à la source lumineuse par ouverture magnétique

RÉF. ID	CULOT	PUISSANCE MAX	FLUX MAX	COULEUR	MATÉRIAU	PRIX HTVA
ID/00776442	2 X GU10	2 X MAX 5W	2 X 575 LM	● NOIR	ALUMINIUM	€ 128,00
ID/00776505	2 X GU10	2 X MAX 5W	2 X 575 LM	● GRAPHITE	ALUMINIUM	€ 128,00

ZORA-LED

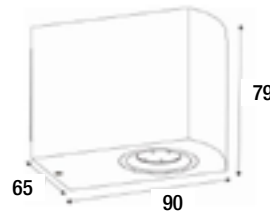
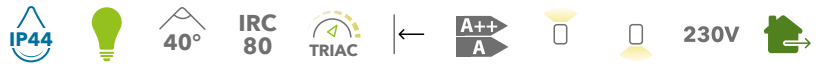

NEW

RÉF. ID	CULOT	PUISSANCE	FLUX	T°	COULEUR	MATÉRIAU	PRIX HTVA
ID/02118029	GU10	5W	320 LM	3000°K	● NOIR	ALUMINIUM	€ 21,00
ID/02118030	GU10	5W	320 LM	3000°K	○ BLANC	ALUMINIUM	€ 21,00

ZORA-LED DOUBLE

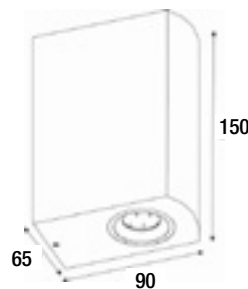

NEW

RÉF. ID	CULOT	PUISSANCE	FLUX	T°	COULEUR	MATÉRIAU	PRIX HTVA
ID/02118031	2 X GU10	2 X 5W	2 X 320 LM	3000°K	● NOIR	ALUMINIUM	€ 35,00
ID/02118032	2 X GU10	2 X 5W	2 X 320 LM	3000°K	○ BLANC	ALUMINIUM	€ 35,00

APPLIQUES EXTÉRIEURES

METRO



ANTI
CORROSION
GARANTIE
10 ANS

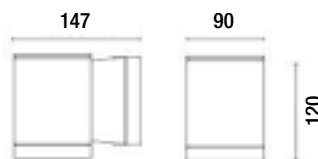

- Accès à la source lumineuse par ouverture magnétique

RÉF. ID	CULOT	PUISSANCE MAX	FLUX MAX	COULEUR	MATÉRIAU	PRIX HTVA
ID/00776446	GU10	MAX 5W	575 LM	● NOIR	ALUMINIUM	€ 74,00
ID/00776509	GU10	MAX 5W	575 LM	● GRAPHITE	ALUMINIUM	€ 74,00

METRO DOUBLE

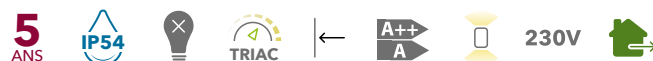

ANTI
CORROSION
GARANTIE
10 ANS

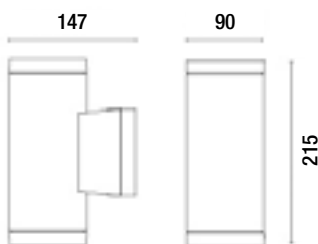

- Accès à la source lumineuse par ouverture magnétique



RÉF. ID	CULOT	PUISSANCE MAX	FLUX MAX	COULEUR	MATÉRIAU	PRIX HTVA
ID/00776448	2 X GU10	2 X MAX 5W	2 X 575 LM	● NOIR	ALUMINIUM	€ 110,00
ID/00776511	2 X GU10	2 X MAX 5W	2 X 575 LM	● GRAPHITE	ALUMINIUM	€ 110,00

Disponible en plafonnier extérieur page 398

APPLIQUES EXTÉRIEURES

COSMOS

LED IP55 IRC 80 230V



- Jeux de deux lentilles 15° et 36° et de deux bagues de finitions inclus

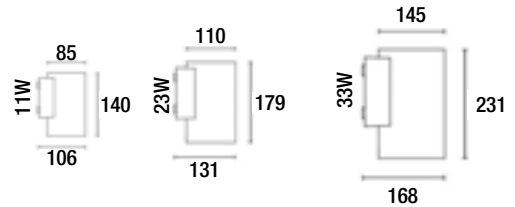

RÉF. ID	PUISSANCE	FLUX	T°	COULEUR	MATÉRIAU	PRIX HTVA
ID/02323046	11W	760 LM	3000°K	● GRIS	ALUMINIUM	€ 174,00
ID/02323047	11W	760 LM	3000°K	● GRIS URBAIN	ALUMINIUM	€ 174,00
ID/02323050	23W	1823 LM	3000°K	● GRIS	ALUMINIUM	€ 239,00
ID/02323051	23W	1823 LM	3000°K	● GRIS URBAIN	ALUMINIUM	€ 239,00
ID/02323054	33W	2367 LM	3000°K	● GRIS	ALUMINIUM	€ 348,00
ID/02323055	33W	2367 LM	3000°K	● GRIS URBAIN	ALUMINIUM	€ 348,00

COSMOS DOUBLE

LED IP55 IRC 80 230V



- Jeux de deux lentilles 15° et 36° et de deux bagues de finitions inclus

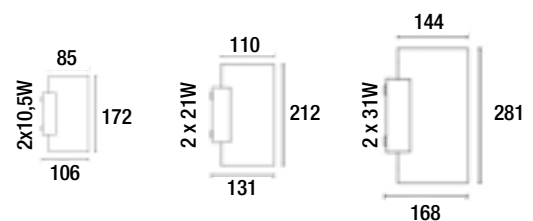

RÉF. ID	PUISSANCE	FLUX	T°	COULEUR	MATÉRIAU	PRIX HTVA
ID/02323048	2 X 10,5W	2 X 912 LM	3000°K	● GRIS	ALUMINIUM	€ 185,00
ID/02323049	2 X 10,5W	2 X 912 LM	3000°K	● GRIS URBAIN	ALUMINIUM	€ 185,00
ID/02323052	2 X 21W	2 X 1823 LM	3000°K	● GRIS	ALUMINIUM	€ 258,00
ID/02323053	2 X 21W	2 X 1823 LM	3000°K	● GRIS URBAIN	ALUMINIUM	€ 258,00
ID/02323056	2 X 31W	2 X 2710 LM	3000°K	● GRIS	ALUMINIUM	€ 380,00
ID/02323057	2 X 31W	2 X 2710 LM	3000°K	● GRIS URBAIN	ALUMINIUM	€ 380,00

APPLIQUES EXTÉRIEURES

QUASAR 10

LED 5 ANS IP44 IRC 80 230V

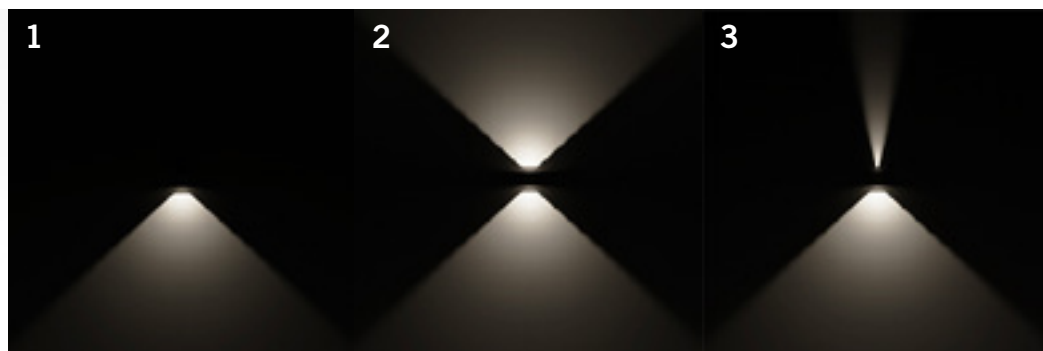
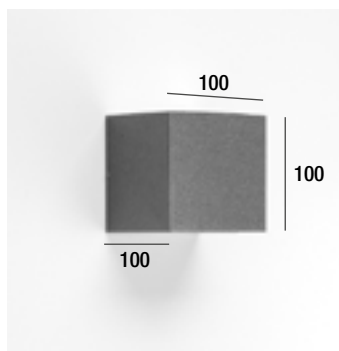

	RÉF. ID	PUISSANCE	FLUX	T°	COULEUR	MATÉRIAU	PRIX HTVA
1	ID/01704651	3,5 W	150 LM	3000°K	● ANTHRACITE	ALUMINIUM	€ 99,00
1	ID/03158945	3,5W	100 LM	3000°K	● NOIR	ALUMINIUM	€ 99,00
2	ID/01704657	6 W	300 LM	3000°K	● ANTHRACITE	ALUMINIUM	€ 133,00
2	ID/03158946	6W	192 LM	3000°K	● NOIR	ALUMINIUM	€ 133,00
3	ID/01704645	6 W	300 LM	3000°K	● ANTHRACITE	ALUMINIUM	€ 133,00

QUASAR 20

LED 5 ANS IP66 IRC 80 230V

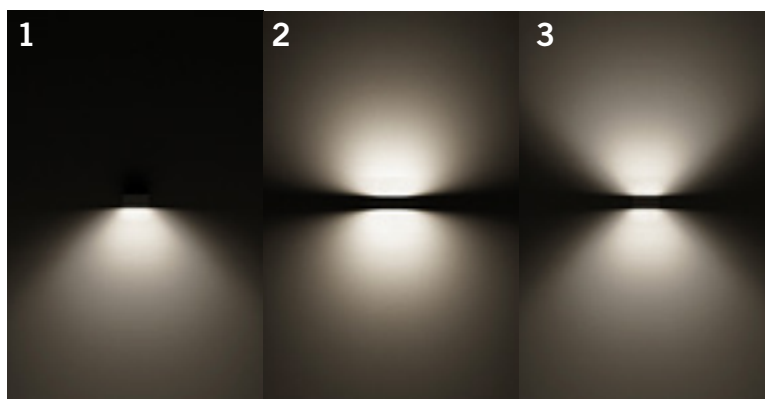
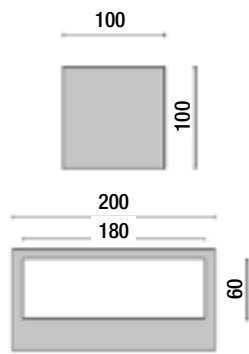

	RÉF. ID	PUISSANCE	FLUX	T°	COULEUR	MATÉRIAU	PRIX HTVA
1	ID/01704672	12,5 W	1000 LM	3000°K	● ANTHRACITE	ALUMINIUM	€ 133,00
1	ID/03158947	12,5W	758 LM	3000°K	● NOIR	ALUMINIUM	€ 133,00
2	ID/01704681	23,2 W	2000 LM	3000°K	● ANTHRACITE	ALUMINIUM	€ 159,00
3	ID/03158948	23W	1714 LM	3000°K	● NOIR	ALUMINIUM	€ 171,00

APPLIQUES EXTÉRIEURES

QUASAR 30

LED 5 ANS IP66 IRC 80 ✕ ← A++ A 230V 🏠

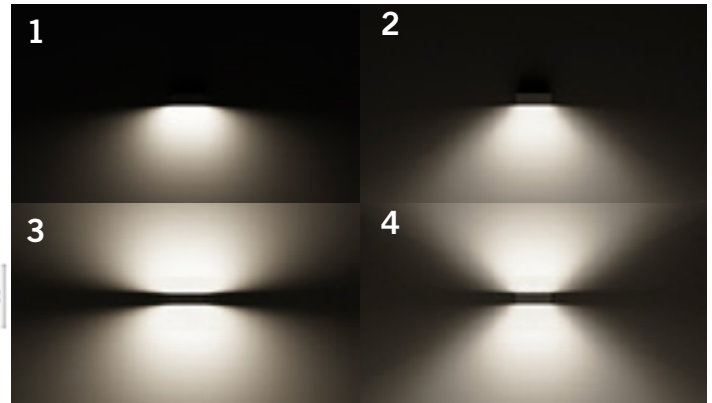
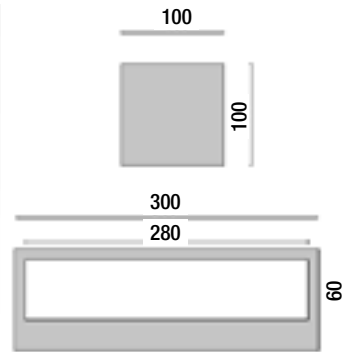

	RÉF. ID	PUISSANCE	FLUX	T°	COULEUR	MATÉRIAU	PRIX HTVA
1	ID/01704687	23,5 W	2000 LM	3000°K	● ANTHRACITE	ALUMINIUM	€ 195,00
2	ID/03158949	23W	1557 LM	3000°K	● NOIR	ALUMINIUM	€ 205,00
3	ID/01704699	32,5 W	3080 LM	3000°K	● ANTHRACITE	ALUMINIUM	€ 261,00
4	ID/03158950	32W	2427 LM	3000°K	● NOIR	ALUMINIUM	€ 282,00

Disponible en plafonnier extérieur page 399

Le conseil de l'éclairagiste:

Pour des projets d'extérieur comprenant de nombreux points lumineux et nécessitant des solutions variées de mise en lumière, optez pour un modèle présentant de multiples possibilités de diffusion.



APPLIQUES EXTÉRIEURES

HOCKENHEIM

LED IP54 IRC >80 A+ 230V

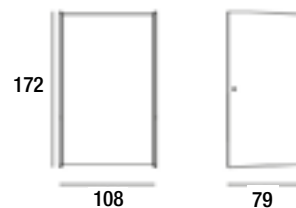
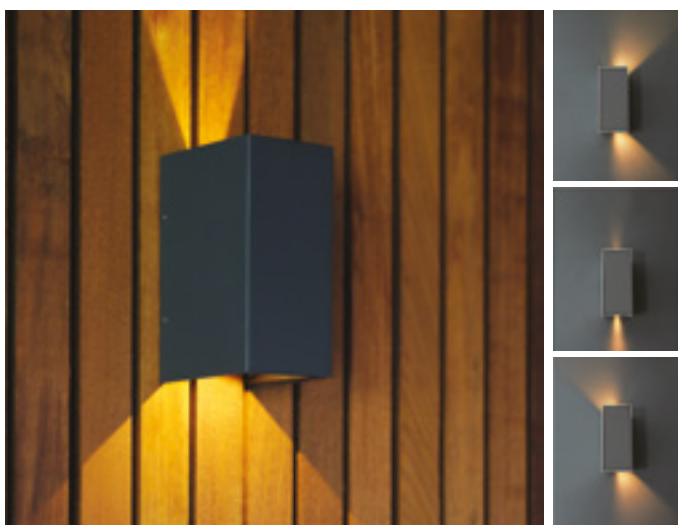

RÉF. ID	PUISSANCE	FLUX	T°	COULEUR	MATÉRIAU	PRIX HTVA
ID/01266723	2 X 3W	2 X 190 LM	3000°K	● ANTHRACITE	ALUMINIUM	€ 110,00

REX 2



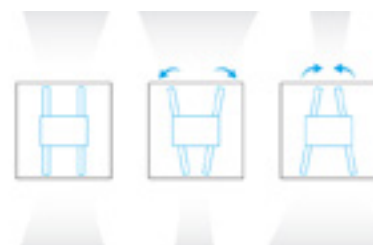
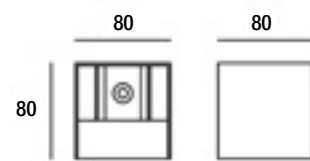

LED 5 ANS IP54 IRC 80 A++/A 230V



RÉF. ID	PUISSANCE	FLUX	T°	COULEUR	MATÉRIAU	PRIX HTVA
ID/02612713	5,2W	244 LM	3000°K	● GRIS URBAIN	ALUMINIUM/VERRE	€ 79,00
ID/02612714	5,2W	244 LM	3000°K	○ BLANC	ALUMINIUM/VERRE	€ 79,00

APPLIQUES EXTÉRIEURES

NUALA

LED IP54 IRC >80   A++/A  230V 

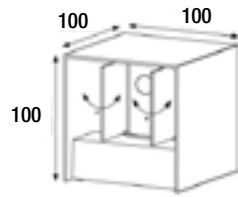

NEW

RÉF. ID	PUISSANCE	FLUX	T°	COULEUR	MATÉRIAU	PRIX HTVA
ID/02878658	2 X 5W	2 X 475 LM	3000°K	● NOIR	ALUMINIUM	€ 65,00



APPLIQUES EXTÉRIEURES



APPLIQUES EXTÉRIEURES

BELFAST

LED 3 ANS IP65 100° IRC 80 ← A → 230V

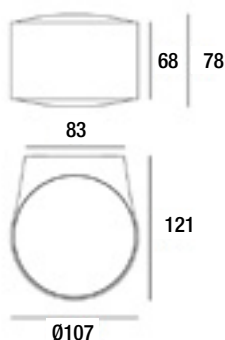
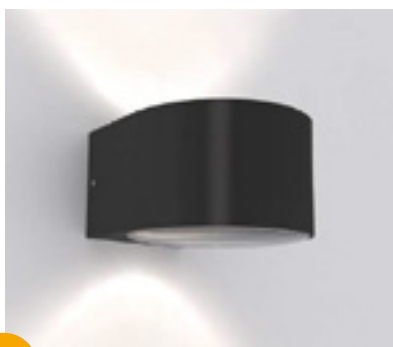

NEW

RÉF. ID	PUISSANCE	FLUX	T°	COULEUR	MATÉRIAU	PRIX HTVA
ID/03383173	12W	2 X 320 LM	3000°K	● NOIR	ALUMINIUM	€ 149,00

GOA

LED 3 ANS IP54 ← A++ A → 230V

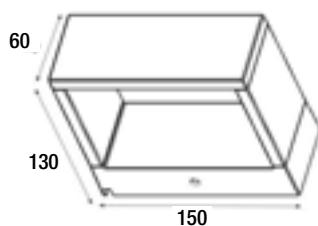

Le conseil de l'éclairagiste:

Certains modèles d'appiques extérieures se déclinent également en bornes. Idéal pour celui ou celle qui souhaite une homogénéité stylistique parfaite pour l'éclairage de ses extérieurs.

NEW

RÉF. ID	PUISSANCE	FLUX	T°	COULEUR	MATÉRIAU	PRIX HTVA
ID/01610104	6W	350 LM	3000°K	● ANTHRACITE	ALUMINIUM	€ 99,00

Disponible en borne page 336

TEXAS

LED 3 ANS IP54 ← A++ A → 230V

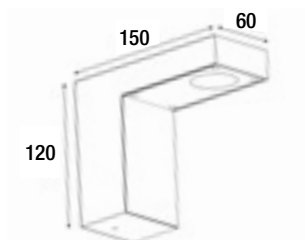

NEW

RÉF. ID	PUISSANCE	FLUX	T°	COULEUR	MATÉRIAU	PRIX HTVA
ID/00817098	6W	230 LM	4000°K	● ANTHRACITE	ALUMINIUM	€ 89,00

Disponible avec détecteur page 300
Disponible en borne page 337



APPLIQUES EXTÉRIEURES

BIDI APPLIQUE

LED IP66 IRC 85     230V 

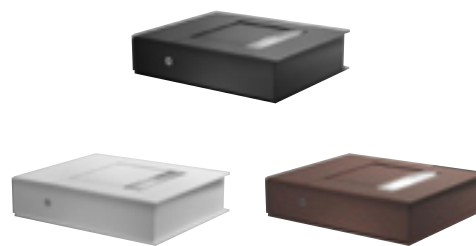
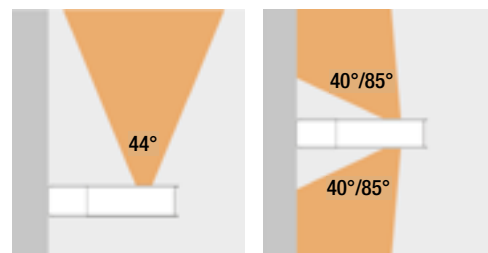
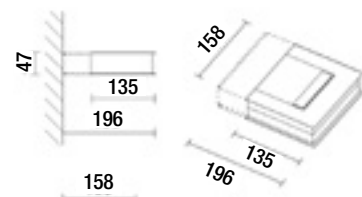

RÉF. ID	PUISSANCE	FLUX	T°	COULEUR	PRIX HTVA
ID/03128839	12 W	1271 LM	3000°K	● NOIR	€ 245,00
ID/02232989	12 W	1271 LM	3000°K	○ BLANC	€ 245,00
ID/02232990	12 W	1271 LM	3000°K	● ROUILLE	€ 245,00
ID/02232986	2 X 12 W	2 X 1271 LM	3000°K	● NOIR	€ 264,00
ID/02232987	2 X 12 W	2 X 1271 LM	3000°K	○ BLANC	€ 264,00
ID/02232988	2 X 12 W	2 X 1271 LM	3000°K	● ROUILLE	€ 264,00

RÉF. ID	ACCESSOIRES	COULEUR	PRIX HTVA
ID/03128838	BASE MURALE	● NOIR	€ 35,00
ID/02232978	BASE MURALE	○ BLANC	€ 35,00
ID/02232979	BASE MURALE	● ROUILLE	€ 35,00

ATTENTION ! IL EST IMPÉRATIF DE COMMANDER LES 2 PARTIES DU SYSTÈME TÊTE + BASE MURALE

Disponible en borne page 368

APPLIQUES EXTÉRIEURES

WALL WASHER

LED IP67 10° IRC 80     230V 

- Idéal pour un éclairage uniforme : mur extérieur par exemple
- Câble de 20cm

Le conseil de l'éclairagiste:

Éclairer un mur sur toute sa longueur et de manière uniforme, c'est ce que permettent les luminaires wall-washer.

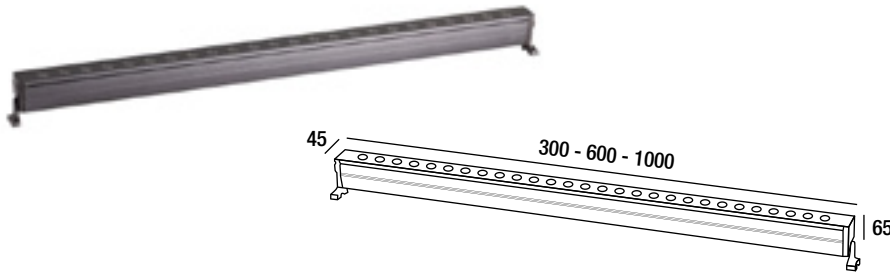

RÉF. ID	PUISSANCE	FLUX	T°	MATÉRIAU	LONGUEUR DU CÂBLE	DIMENSIONS MM	PRIX HTVA
ID/02644181	6W	660 LM	3200°K	ALU	200	300 X 45 X 63	€ 84,00
ID/02644180	12W	1320 LM	3200°K	ALU	200	600 X 45 X 63	€ 107,00
ID/02644179	36W	3960 LM	3200°K	ALU	200	1000 X 45 X 63	€ 163,00



APPLIQUES EXTÉRIEURES

POLO+ ZERO

LED 5 ANS IP65 IRC 80    230V 

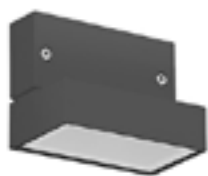

NEW

RÉF. ID	PUISSANCE	FLUX	T°	COULEUR	MATÉRIAU	PRIX HTVA
ID/02499757	6,5W	237 LM	3000°K	● ANTHRACITE	ALUMINIUM	€ 45,00
ID/02499758	6,5W	237 LM	3000°K	○ BLANC	ALUMINIUM	€ 45,00
ID/02499760	6,5W	271 LM	4000°K	● ANTHRACITE	ALUMINIUM	€ 45,00
ID/02499761	6,5W	271 LM	4000°K	○ BLANC	ALUMINIUM	€ 45,00

POLO+ 1

LED 5 ANS IP65 IRC 80    230V 



NEW

RÉF. ID	PUISSANCE	FLUX	T°	COULEUR	MATÉRIAU	PRIX HTVA
ID/02499743	11.5W	474 LM	3000°K	● ANTHRACITE	ALUMINIUM	€ 73,00
ID/02499741	11,5W	474 LM	3000°K	○ BLANC	ALUMINIUM	€ 73,00
ID/02499745	11.5W	488 LM	4000°K	● ANTHRACITE	ALUMINIUM	€ 73,00
ID/02499746	11.5W	488 LM	4000°K	○ BLANC	ALUMINIUM	€ 73,00

APPLIQUES EXTÉRIEURES

POLO+ 2

LED 5 ANS IP65 IRC 80 230V

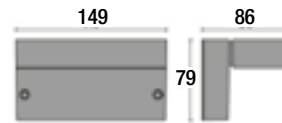

NEW

RÉF. ID	PUISSANCE	FLUX	T°	COULEUR	MATÉRIAU	PRIX HTVA
ID/02499747	11.5W	438 LM	3000°K	● ANTHRACITE	ALUMINIUM	€ 73,00
ID/02499748	11.5W	438 LM	3000°K	○ BLANC	ALUMINIUM	€ 73,00
ID/02499749	11.5W	451 LM	4000°K	● ANTHRACITE	ALUMINIUM	€ 73,00
ID/02499750	11.5W	451 LM	4000°K	○ BLANC	ALUMINIUM	€ 73,00

POLO+ 3

LED 5 ANS IP65 IRC 80 230V

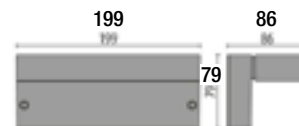





NEW

RÉF. ID	PUISSANCE	FLUX	T°	COULEUR	MATÉRIAU	PRIX HTVA
ID/02499753	17W	620 LM	3000°K	● ANTHRACITE	ALUMINIUM	€ 91,00
ID/02499754	17W	620 LM	3000°K	○ BLANC	ALUMINIUM	€ 91,00
ID/02499755	17W	673 LM	4000°K	● ANTHRACITE	ALUMINIUM	€ 91,00
ID/02499756	17W	673 LM	4000°K	○ BLANC	ALUMINIUM	€ 91,00

APPLIQUES EXTÉRIEURES

SLAT





LED IP65 240°     230V 

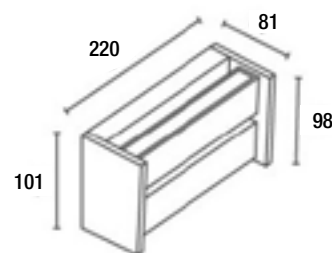

- Deux diffuseurs orientables individuellement
- Fixation mur ou plafond
- Gestion électronique intelligente





APPLIQUES EXTÉRIEURES

RÉF. ID	PUISSANCE	FLUX	T°	COULEUR	MATÉRIAU	PRIX HTVA
ID/02179832	2 X 8W	2 X 345 LM	3000°K	 ANTHRACITE	ALUMINIUM	€ 352,00
ID/02179833	2 X 8W	2 X 345 LM	3000°K	 BRUN	ALUMINIUM	€ 352,00
ID/02374941	2 X 8W	2 X 345 LM	3000°K	 BLANC	ALUMINIUM	€ 352,00
ID/02374942	2 X 8W	2 X 345 LM	3000°K	 GRIS	ALUMINIUM	€ 352,00
ID/02661691	2 X 8W	2 X 345 LM	3000°K	 NOIR SATINE	ALUMINIUM	€ 352,00

APPLIQUES EXTÉRIEURES

SLAT ONE

LED IP65 240°        230V 

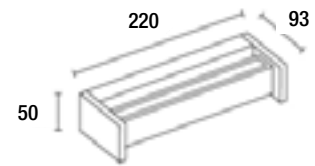

NEW

RÉF. ID	PUISSANCE	FLUX	T°	COULEUR	MATÉRIAU	PRIX HTVA
ID/02661692	8W	294 LM	3000°K	● ANTHRACITE	ALUMINIUM	€ 248,00
ID/02661693	8W	294 LM	3000°K	● BRUN	ALUMINIUM	€ 248,00
ID/02661695	8W	294LM	3000°K	○ BLANC	ALUMINIUM	€ 248,00
ID/02661694	8W	294 LM	3000°K	● GRIS	ALUMINIUM	€ 248,00
ID/02661696	8W	294 LM	3000°K	● NOIR SATINE	ALUMINIUM	€ 248,00



APPLIQUES EXTÉRIEURES

CLAIRE



230V



RÉF. ID	CULOT	PUISSANCE MAX	FLUX MAX	COULEUR	MATÉRIAU	DIMENSIONS MM	PRIX HTVA
ID/02539723	E27	MAX 9W	800 LM	● NOIR	ALUMINIUM/ VERRE	90 X 110 X 200	€ 58,00
ID/02539724	2 X E27	2 X MAX 9W	2 X 800 LM	● NOIR	ALUMINIUM/ VERRE	90 X 110 X 360	€ 78,00
ID/02325463	E27	MAX 9W	800 LM	● NOIR	ALUMINIUM/ VERRE	180 X 176 X 300	€ 94,00
ID/02509835	2 X E27	2 X MAX 9W	2 X 800 LM	● NOIR	ALUMINIUM/ VERRE	140 X 140 X 400	€ 116,00

Disponible en borne page 340

APPLIQUES EXTÉRIEURES



APPLIQUES EXTÉRIEURES

BRICK



230V

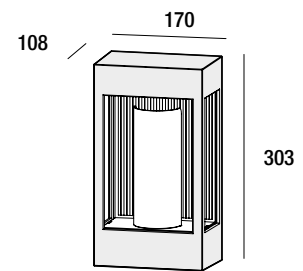

RÉF. ID	CULOT	PUISSANCE MAX	FLUX MAX	COULEUR	MATÉRIAU	PRIX HTVA
ID/02640063	E27	MAX 9 W	800 LM	● ANTHRACITE	ALUMINIUM/ VERRE	€ 179,00
ID/02640076	E27	MAX 9 W	800 LM	● GRES	ALUMINIUM/ VERRE	€ 179,00
ID/02640074	E27	MAX 9 W	800 LM	● ROUILLE	ALUMINIUM/ VERRE	€ 179,00
ID/02640075	E27	MAX 9 W	800 LM	● SABLE	ALUMINIUM/ VERRE	€ 179,00
ID/02640079	E27	MAX 9 W	800 LM	● GRIS ARDOISE	ALUMINIUM/ VERRE	€ 179,00
ID/02640064	E27	MAX 9 W	800 LM	○ BLANC PUR	ALUMINIUM/ VERRE	€ 179,00
ID/02640066	E27	MAX 9 W	800 LM	● GRIS NOIR	ALUMINIUM/ VERRE	€ 179,00
ID/02640070	E27	MAX 9 W	800 LM	● NOIR VELOURS	ALUMINIUM/ VERRE	€ 179,00



APPLIQUES EXTÉRIEURES

YELI

LED 3 ANS IP54 105° IRC 80

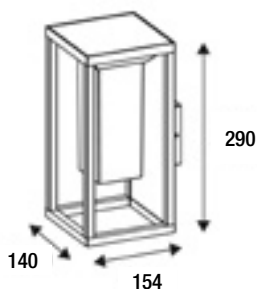

Le conseil de l'éclairagiste:

Avec une évolution technique importante ces dernières années, les luminaires à énergie solaire permettent d'amener un éclairage fiable là où les arrivées électriques font défaut

NEW

RÉF. ID	PUISSANCE	FLUX	T°	COULEUR	MATÉRIAU	PRIX HTVA
ID/03286987	3,7W	600 LM	4000°K	● ANTHRACITE	ALUMINIUM	€ 148,00



APPLIQUES EXTÉRIEURES

APPLIQUES EXTÉRIEURES

SINGA

LED 3 ANS IP54    230V 

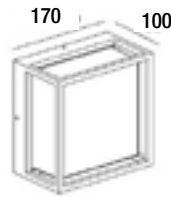

NEW

RÉF. ID	PUISSANCE	FLUX	T°	COULEUR	MATÉRIAU	PRIX HTVA
ID/02612016	9.6W	550 LM	2700°K	● NOIR	ALUMINIUM	€ 78,00



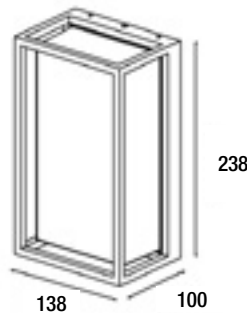

NERES

LED IP65 IRC >80    230V 



RÉF. ID	PUISSANCE	FLUX	T°	COULEUR	MATÉRIAU	PRIX HTVA
ID/02878562	9W	1100 LM	3000°K	● NOIR	ACIER / PLEXI	€ 95,00

DUKAN

IP65  TRIAC   230V 

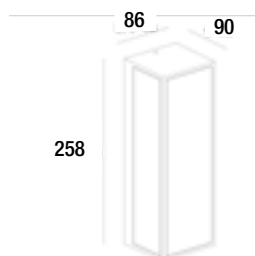

NEW

RÉF. ID	CULOT	PUISSANCE MAX	FLUX MAX	COULEUR	MATÉRIAU	PRIX HTVA
ID/03170108	E27	MAX 9W	800LM	● NOIR	ALUMINIUM / VERRE	€ 57,00

Disponible en plafonnier page 401

APPLIQUES EXTÉRIEURES

RONDO WALL

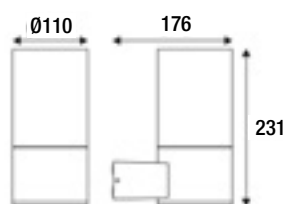

Le conseil de l'éclairagiste:

Un verre opalin maximisera l'uniformité de la diffusion lumineuse tout en minimisant les effets d'éblouissement. Le verre transparent fera la part belle à l'esthétique de l'ampoule; tout comme le verre fumé qui lui apportera en plus une touche plus intimiste.

NEW

RÉF. ID	CULOT	PUISSANCE MAX	FLUX MAX	COULEUR	MATÉRIAU	PRIX HTVA
ID/03286981	E27	MAX 9W	800 LM	○ VERRE OPALIN	ALUMINIUM	€ 94,00
ID/03286982	E27	MAX 9W	800 LM	● VERRE CLAIR	ALUMINIUM	€ 94,00
ID/03286983	E27	MAX 9W	800 LM	● VERRE FUME	ALUMINIUM	€ 94,00

Disponible en borne page 333

NINKE WALL

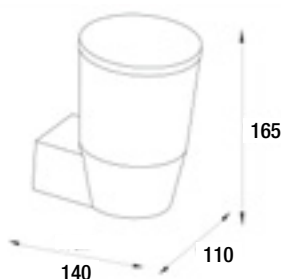

NEW

RÉF. ID	CULOT	PUISSANCE MAX	FLUX MAX	COULEUR	MATÉRIAU	PRIX HTVA
ID/02612013	GU10	MAX 9W	575 LM	● NOIR	ALUMINIUM	€ 31,00

Disponible en borne page 330

APPLIQUES EXTÉRIEURES

TIRENO WALL



230V



1



2

NEW

	RÉF. ID	CULOT	PUISSANCE MAX	FLUX MAX	COULEUR	MATÉRIAU	PRIX HTVA
1	ID/00546835	E27	MAX 9W	800 LM	● NOIR	ALUMINIUM	€ 28,00
2	ID/00546832	E27	MAX 9W	800 LM	● NOIR	ALUMINIUM	€ 28,00

Disponible en borne page 341

APPLIQUES EXTÉRIEURES

APPLIQUES EXTÉRIEURES

DUDLEY DOWN



230V

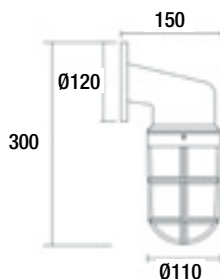

NEW

RÉF. ID	CULOT	PUISSANCE MAX	FLUX MAX	COULEUR	MATÉRIAU	PRIX HTVA
ID/03382583	E27	MAX 9W	800 LM	● OR MAT/LAITON	ALUMINIUM	€ 69,00
ID/03382584	E27	MAX 9W	800 LM	● NOIR	ALUMINIUM	€ 69,00

DUDLEY OVAL



230V

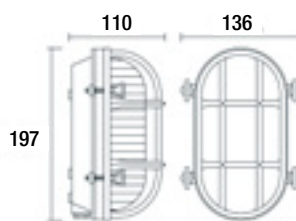

NEW

RÉF. ID	CULOT	PUISSANCE MAX	FLUX MAX	COULEUR	MATÉRIAU	PRIX HTVA
ID/03382581	E27	MAX 9W	800 LM	● OR MAT/LAITON	ALUMINIUM	€ 52,00
ID/03382582	E27	MAX 9W	800 LM	● NOIR	ALUMINIUM	€ 52,00

APPLIQUES EXTÉRIEURES



APPLIQUES EXTÉRIEURES

DUDLEY ROUND



230V



NEW

RÉF. ID	CULOT	PUISSANCE MAX	FLUX MAX	COULEUR	MATÉRIAU	PRIX HTVA
ID/03382579	E27	MAX 9W	800 LM	● OR MAT/LAITON	ALUMINIUM	€ 73,00
ID/03382580	E27	MAX 9W	800 LM	● NOIR	ALUMINIUM	€ 73,00

DINGO



IRC 80



230V

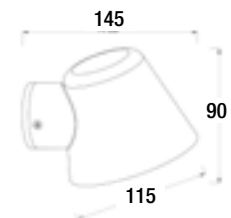

NEW

RÉF. ID	CULOT	SOURCE INCLUSE	FLUX	T°	COULEUR	MATÉRIAU	PRIX HTVA
ID/02085364	GU10	5W	320 LM	3000°K	● NOIR	ALUMINIUM	€ 35,00
ID/02085365	GU10	5W	320 LM	3000°K	○ BLANC	ALUMINIUM	€ 35,00

Disponible en borne page 334

APPLIQUES EXTÉRIEURES

YIKA

LED 5 ANS IP44 IRC 80 A++ A 230V

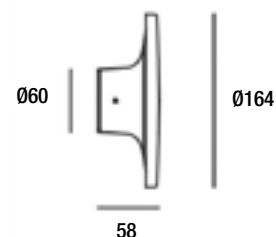

NEW

RÉF. ID	PUISSANCE	FLUX	T°	COULEUR	MATÉRIAU	PRIX HTVA
ID/03328604	6.3W	677 LM	3000°K	● NOIR	POLYCARBONATE	€ 39,00

WIDO

LED 3 ANS IP65 180° IRC >80 A++ A 230V



- Effet de lame de lumière
- Idéal pour les façades, baies de portes et fenêtres, couloirs...
- Convertisseur non dimmable intégré dans l'appareil
- Accessoire pour montage sur surface inclinée fourni

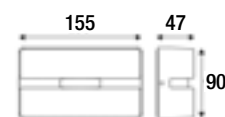

NEW

RÉF. ID	PUISSANCE	FLUX	T°	COULEUR	MATÉRIAU	PRIX HTVA
ID/03286984	3W	220 LM	3000°K	● ANTHRACITE	ALUMINIUM	€ 90,00

APPLIQUES EXTÉRIEURES

APPLIQUES EXTÉRIEURES

THESI

LED 3 ANS IP54 ✕ ← A++ A 230V 🏠

Le conseil de l'éclairagiste:

Ces luminaires à double fonction vous permettent d'indiquer votre numéro de maison et de le rendre visible à la nuit tombée. Idéal pour les commerces et professions libérales.

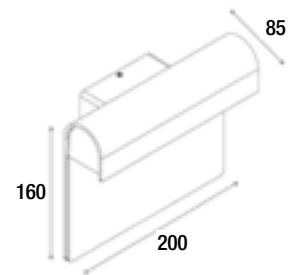
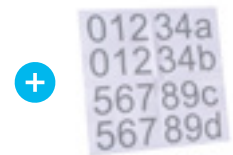

NEW

RÉF. ID	PUISSANCE	FLUX	T°	COULEUR	MATÉRIAU	PRIX HTVA
ID/02325461	6W	220 LM	3000°K	● NOIR	ALUMINIUM	€ 73,00

CADRA

LED 3 ANS IP54 ✕ ← A++ A 230V 🏠

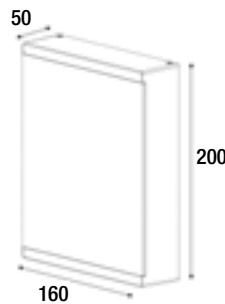
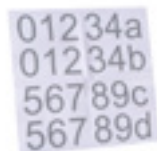

NEW

RÉF. ID	PUISSANCE	FLUX	T°	COULEUR	MATÉRIAU	PRIX HTVA
ID/02325459	6W	312 LM	3000°K	○ BLANC	ALUMINIUM/VERRE	€ 66,00

APPLIQUES EXTÉRIEURES

APPLIQUES EXTÉRIEURES

WALL

LED 5 ANS IP65 IRC 80 A++ A 230V

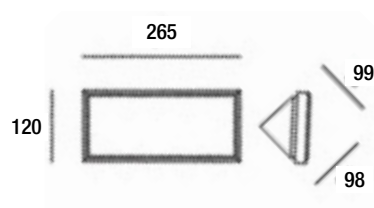

NEW

RÉF. ID	PUISSANCE	FLUX	T°	COULEUR	MATÉRIAU	PRIX HTVA
ID/02612686	10.5W	615 LM	3000°K	● GRIS	POLYCARBONATE	€ 75,00
ID/02612687	10.5W	615 LM	3000°K	● NOIR	POLYCARBONATE	€ 75,00

CURIE

LED IP65 IRC 80 A++ A 230V

- Protection contre les rayons UV

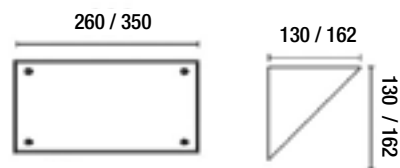

RÉF. ID	PUISSANCE	FLUX	T°	COULEUR	MATÉRIAU	DIMENSIONS MM	PRIX HTVA
ID/02323007	14W	412 LM	3000°K	○ BLANC	ALUMINIUM / VERRE	130 X 130 X 260	€ 138,00
ID/02323008	14W	412 LM	4000°K	○ BLANC	ALUMINIUM / VERRE	130 X 130 X 260	€ 138,00
ID/02323009	14W	412 LM	3000°K	● GRIS	ALUMINIUM / VERRE	130 X 130 X 260	€ 138,00
ID/02323010	14W	412 LM	4000°K	● GRIS	ALUMINIUM / VERRE	130 X 130 X 260	€ 138,00
ID/02614445	25,2W	1530 LM	3000°K	● GRIS	ALUMINIUM / VERRE	162 X 162 X 350	€ 292,00
ID/02614446	25,2W	1530 LM	4000°K	● GRIS	ALUMINIUM / VERRE	162 X 162 X 350	€ 292,00

APPLIQUES EXTÉRIEURES

SERENATE

LED 5 ANS IP44 IRC 80 ← A++ A 230V

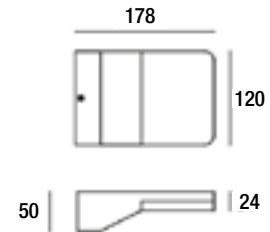

RÉF. ID	PUISSANCE	FLUX	T°	COULEUR	MATÉRIAU	PRIX HTVA
ID/02612670	8,5W	1000 LM	3000°K	● NOIR	ALUMINIUM / POLYCARBONATE	€ 69,00

APRIL

LED 5 ANS IP54 90° IRC 80 ← A++ A 230V

-Têtes lumineuses orientables

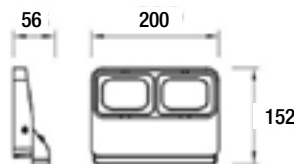

NEW

RÉF. ID	PUISSANCE	FLUX	T°	COULEUR	MATÉRIAU	PRIX HTVA
ID/03328602	11W	1084 LM	3000°K	● GRIS URBAIN	ALUMINIUM / POLYCARBONATE	€ 119,00



APPLIQUES EXTÉRIEURES

SPIKE SIMPLE

LED 5 ANS IP44 95° IRC >80 TRIAC ← A++ A 230V



ANTI
CORROSION
GARANTIE
10 ANS

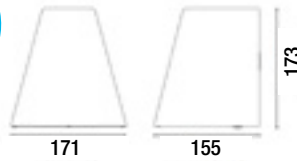

RÉF. ID	PUISSANCE	FLUX	T°	COULEUR	PRIX HTVA
ID/02091116	11W	720 LM	3000°K	● GRAPHITE	€ 153,00
ID/02091094	11W	720 LM	3000°K	● NOIR MAT	€ 153,00

SPIKE DOUBLE

LED 5 ANS IP44 95° IRC >80 TRIAC ← A++ A 230V



ANTI
CORROSION
GARANTIE
10 ANS

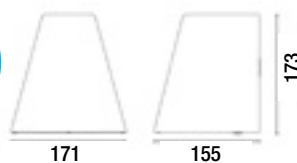

- Downlight : LED intégré
- Uplight : GU10 LED remplaçable

RÉF. ID	PUISSANCE	FLUX	T°	COULEUR	ANGLE	PRIX HTVA
ID/02091119	BAS : 11 W HAUT : 6W	BAS : 800 LM HAUT : 300LM	3000°K	● GRAPHITE	BAS : 95° HAUT : 15°	€ 210,00
ID/02091097	BAS : 11 W HAUT : 6W	BAS : 800 LM HAUT : 300LM	3000°K	● NOIR MAT	BAS : 95° HAUT : 15°	€ 210,00

SPIKE DOUBLE + 2 PRISES

LED 5 ANS IP44 95° IRC >80 TRIAC ← A++ A 230V



ANTI
CORROSION
GARANTIE
10 ANS

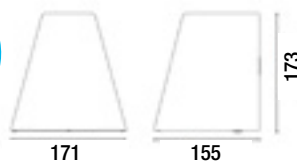





- Deux prises intégrées sous le luminaire
- Downlight : LED intégré
- Uplight : GU10 LED remplaçable

RÉF. ID	PUISSANCE	FLUX	T°	COULEUR	ANGLE	PRIX HTVA
ID/02091084	BAS : 11 W HAUT : 6W	BAS : 800 LM HAUT : 300LM	3000°K	○ BLANC MAT	BAS : 95° HAUT : 15°	€ 220,00
ID/02091121	BAS : 11 W HAUT : 6W	BAS : 800 LM HAUT : 300LM	3000°K	● GRAPHITE	BAS : 95° HAUT : 15°	€ 220,00
ID/02091099	BAS : 11 W HAUT : 6W	BAS : 800 LM HAUT : 300LM	3000°K	● NOIR MAT	BAS : 95° HAUT : 15°	€ 220,00

APPLIQUES EXTÉRIEURES

GEOLED

LED IP65 IRC >80     230V 



Le conseil de l'éclairagiste:

Certains projets nécessitent un éclairage de qualité mais aussi de respecter un budget contenu. C'est le cas, par exemple, des gîtes ou des espaces destinés à la location en général. Pour l'extérieur aussi, des solutions hyper intéressantes existent.

RÉF. ID	PUISSANCE	FLUX	T°	COULEUR	DIMENSIONS MM	MATÉRIAU	PRIX HTVA
ID/02108587	15W	1250 LM	3000°K	○ BLANC	Ø 166 X 62	POLYCARBONATE	€ 25,00
ID/02108591	15W	2025 LM	3000°K	● NOIR	Ø 166 X 62	POLYCARBONATE	€ 25,00
ID/02108588	15W	1250 LM	4000°K	○ BLANC	Ø 166 X 62	POLYCARBONATE	€ 25,00
ID/02108592	15W	2025 LM	4000°K	● NOIR	Ø 166 X 62	POLYCARBONATE	€ 25,00
ID/02108589	20W	1650 LM	3000°K	○ BLANC	Ø 220 X 71	POLYCARBONATE	€ 28,00
ID/02108593	20W	2700 LM	3000°K	● NOIR	Ø 220 X 71	POLYCARBONATE	€ 28,00
ID/02108590	20W	1650 LM	4000°K	○ BLANC	Ø 220 X 71	POLYCARBONATE	€ 28,00
ID/02108594	20W	2700 LM	4000°K	● NOIR	Ø 220 X 71	POLYCARBONATE	€ 28,00

NEW FLASH

LED 5 ANS IP65 IRC 80     230V 

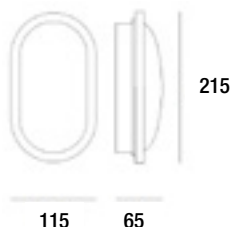









NEW

RÉF. ID	PUISSANCE	FLUX	T°	COULEUR	MATÉRIAU	PRIX HTVA
ID/03328609	13.4W	1401 LM	3000°K	○ BLANC	POLYCARBONATE	€ 25,00
ID/03328610	13.4W	1401 LM	3000°K	● NOIR	POLYCARBONATE	€ 25,00

APPLIQUES EXTÉRIEURES

GEOLED

LED IP65 IRC >80        230V 



RÉF. ID	PUISSANCE	FLUX	T°	COULEUR	DIMENSIONS MM	MATÉRIAU	PRIX HTVA
ID/02108579	15W	1250 LM	3000°K	○ BLANC	63 X 114 X 214	POLYCARBONATE	€ 25,00
ID/02108583	15W	1250 LM	3000°K	● NOIR	63 X 114 X 214	POLYCARBONATE	€ 25,00
ID/02108580	15W	1250 LM	4000°K	○ BLANC	63 X 114 X 214	POLYCARBONATE	€ 25,00
ID/02108584	15W	1250 LM	4000°K	● NOIR	63 X 114 X 214	POLYCARBONATE	€ 25,00
ID/02108581	20W	1650 LM	3000°K	○ BLANC	74 X 145 X 269	POLYCARBONATE	€ 28,00
ID/02108585	20W	1650 LM	3000°K	● NOIR	74 X 145 X 269	POLYCARBONATE	€ 28,00
ID/02108582	20W	1650 LM	4000°K	○ BLANC	74 X 145 X 269	POLYCARBONATE	€ 28,00
ID/02108586	20W	1650 LM	4000°K	● NOIR	74 X 114 X 269	POLYCARBONATE	€ 28,00

RHINO

LED 5 ANS IP65 IRC 80        230V 

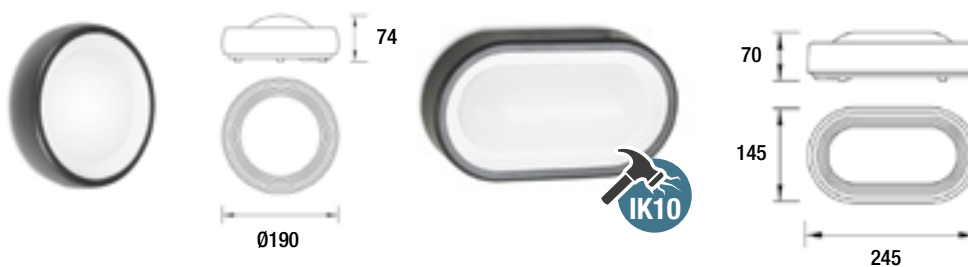

- Idéal pour bord de mer

RÉF. ID	PUISSANCE	FLUX	T°	COULEUR	MATÉRIAU	DIMENSIONS MM	PRIX HTVA
ID/02257552	8W	900 LM	4000°K	● GRIS URBAIN	POLYCARBONATE	Ø 190 X 74	€ 45,00
ID/02257553	9W	1050 LM	4000°K	● GRIS URBAIN	POLYCARBONATE	245 X 145 X 70	€ 47,00

APPLIQUES EXTÉRIEURES

COLOGNE

LED IP54 IRC >80 ✕ ← A+ 230V 🏠

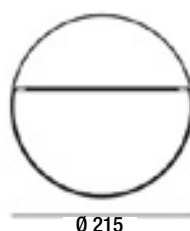
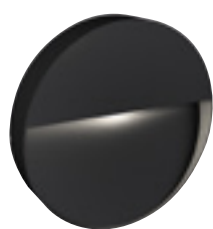

- Possibilité de repiquage
(2 presse-étoupes)

RÉF. ID	PUISSANCE	FLUX	T°	COULEUR	MATÉRIAU	FORME	PRIX HTVA
ID/02517929	9W	260 LM	3000°K	● ANTHRACITE	ALUMINIUM	ROND	€ 78,00
ID/02517931	9W	260 LM	3000°K	● ANTHRACITE	ALUMINIUM	CARRÉ	€ 78,00



APPLIQUES EXTÉRIEURES



APPLIQUES EXTÉRIEURES

FRAME MINI

LED 5 ANS IP66 IRC >80 TRIAC ← A++ A 230V 



ANTI
CORROSION
GARANTIE
10 ANS

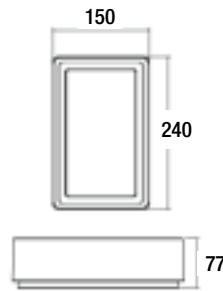

- Platine LED remplaçable

RÉF. ID	PUISSANCE	FLUX	T°	COULEUR	MATÉRIAU	PRIX HTVA
ID/02628676	6 W	480 LM	3000°K	○ BLANC	ALUMINIUM / POLYCARBONATE	€ 104,00
ID/02628678	6 W	480 LM	3000°K	● NOIR	ALUMINIUM / POLYCARBONATE	€ 104,00
ID/02628677	6 W	480 LM	3000°K	● GRAPHITE	ALUMINIUM / POLYCARBONATE	€ 104,00



APPLIQUES EXTÉRIEURES

FRAME ROUND

LED 5 ANS IP66 IRC >80 TRIAC ↑ ↓ A++ A 230V



- Platine LED remplaçable
- Réglage puissance éclairage par Dip switch de l'alimentation

Le conseil de l'éclairagiste:

Le réglage par Dip-switch permet de commander au convertisseur de fournir un ampérage plus important à la LED et d'ainsi en augmenter son flux lumineux.

RÉF. ID	PUISSANCE	FLUX	T°	COULEUR	MATÉRIAU	PRIX HTVA
ID/02628684	7 W	670 LM	3000°K	○ BLANC	ALUMINIUM / POLYCARBONATE	€ 136,00
ID/02628706	7 W	670 LM	3000°K	● NOIR	ALUMINIUM / POLYCARBONATE	€ 136,00
ID/02628682	7 W	670 LM	3000°K	● GRAPHITE	ALUMINIUM / POLYCARBONATE	€ 136,00
ID/02628687	7 W	670 LM	4000°K	○ BLANC	ALUMINIUM / POLYCARBONATE	€ 136,00
ID/02628708	7 W	670 LM	4000°K	● NOIR	ALUMINIUM / POLYCARBONATE	€ 136,00
ID/02628690	7 W	670 LM	4000°K	● GRAPHITE	ALUMINIUM / POLYCARBONATE	€ 136,00

Disponible avec détecteur page 298

FRAME SQUARE

LED 5 ANS IP66 IRC >80 TRIAC ↑ ↓ A++ A 230V



- Platine LED remplaçable
- Réglage puissance éclairage par Dip switch de l'alimentation

RÉF. ID	PUISSANCE	FLUX	T°	COULEUR	MATÉRIAU	PRIX HTVA
ID/02628709	6 W	500 LM	3000°K	○ BLANC	ALUMINIUM / POLYCARBONATE	€ 136,00
ID/02628735	6 W	500 LM	3000°K	● NOIR	ALUMINIUM / POLYCARBONATE	€ 136,00
ID/02628713	6 W	500 LM	3000°K	● GRAPHITE	ALUMINIUM / POLYCARBONATE	€ 136,00
ID/02628712	6 W	520 LM	4000°K	○ BLANC	ALUMINIUM / POLYCARBONATE	€ 136,00
ID/02628738	6 W	520 LM	4000°K	● NOIR	ALUMINIUM / POLYCARBONATE	€ 136,00
ID/02628716	6 W	520 LM	4000°K	● GRAPHITE	ALUMINIUM / POLYCARBONATE	€ 136,00

Disponible avec détecteur page 298

APPLIQUES EXTÉRIEURES

FRAME ROUND WALL

LED 5 ANS IP66 IRC >80 TRIAC ← A++ A 230V



ANTI CORROSION GARANTIE 10 ANS

IK10

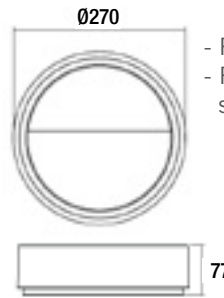

- Platine LED remplaçable
- Réglage puissance éclairage par Dip switch de l'alimentation

RÉF. ID	PUISSANCE	FLUX	T°	COULEUR	MATÉRIAU	PRIX HTVA
ID/02949611	7 W	390 LM	3000°K	○ BLANC	ALUMINIUM / POLYCARBONATE	€ 162,00
ID/02949612	7 W	390 LM	3000°K	● NOIR	ALUMINIUM / POLYCARBONATE	€ 162,00
ID/02949609	7 W	390 LM	3000°K	● GRAPHITE	ALUMINIUM / POLYCARBONATE	€ 162,00

FRAME SQUARE WALL

LED 5 ANS IP66 IRC >80 TRIAC ← A++ A 230V



ANTI CORROSION GARANTIE 10 ANS

IK10

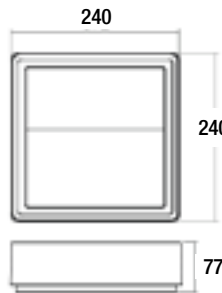

- Platine LED remplaçable
- Réglage puissance éclairage par Dip switch de l'alimentation

RÉF. ID	PUISSANCE	FLUX	T°	COULEUR	MATÉRIAU	PRIX HTVA
ID/02949614	7 W	300 LM	3000°K	○ BLANC	ALUMINIUM / POLYCARBONATE	€ 162,00
ID/02949615	7 W	300 LM	3000°K	● NOIR	ALUMINIUM / POLYCARBONATE	€ 162,00
ID/02949613	7 W	300 LM	3000°K	● GRAPHITE	ALUMINIUM / POLYCARBONATE	€ 162,00



BALISAGES EXTÉRIEURS

COLOGNE MINI

LED IP54 IRC >80 IK08 ← 230V

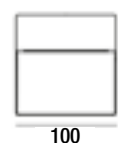

100

Ø 100

30

100

30

RÉF. ID	PUISSANCE	FLUX	T°	COULEUR	MATÉRIAU	FORMAT	PRIX HTVA
ID/02517928	3W	250 LM	3000°K	● ANTHRACITE	ALUMINIUM	ROND	€ 67,00
ID/02517930	3W	250 LM	3000°K	● ANTHRACITE	ALUMINIUM	CARRÉ	€ 67,00

CALLISTO WALL

LED 5 ANS IP65 IRC >80 TRIAC ← 230V

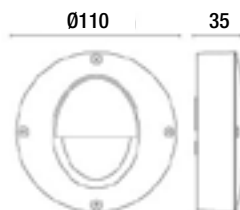

- Classe III : peut être monté sans terre
- Bornes de mise en boucle rapide.

ANTI CORROSION GARANTIE 10 ANS

RÉF. ID	PUISSANCE	FLUX	T°	COULEUR	MATÉRIAU	PRIX HTVA
ID/02324198	4W	120 LM	3000°K	○ BLANC	ALUMINIUM	€ 81,00
ID/02324228	4W	120 LM	3000°K	● NOIR MAT	ALUMINIUM	€ 81,00
ID/02324246	4W	120 LM	3000°K	● GRAPHITE	ALUMINIUM	€ 81,00

Disponible en plafonnier extérieur page 400

Le conseil de l'éclairagiste:

Discret le jour mais tellement présent et fonctionnel le soir, le luminaire de balisage sécurise autant qu'il sublime l'extérieur de la maison et ses alentours.

BALISAGES EXTÉRIEURS

DOME

LED 3 ANS IP65 IRC >80 A++ A 230V

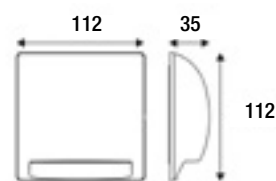

NEW

RÉF. ID	PUISSANCE	FLUX	T°	COULEUR	MATÉRIAU	PRIX HTVA
ID/03382900	3W	215 LM	3000°K	● ANTHRACITE	ALUMINIUM	€ 60,00

ITO

LED 3 ANS IP65 IRC >80 A+ 230V

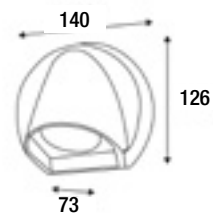

RÉF. ID	PUISSANCE	FLUX	T°	COULEUR	MATÉRIAU	PRIX HTVA
ID/02682408	6W	320 LM	3000°K	● ANTHRACITE	ALUMINIUM	€ 110,00

APPLIQUES EXTÉRIEURES

PLAFONNIERS ET ENCASTRÉS EXTÉRIEURS

PAGES 396 À 405

Les plafonniers et spots encastrés extérieurs offrent, selon le modèle, le choix d'un éclairage ponctuel (qui apporte du dynamisme) ou diffus (qui apporte de l'homogénéité) à vos sous-toitures, auvents, pergolas...



PLAFONNIERS EXTÉRIEURS



METRO
398



ECHO
398



BOXY +
398



NEW

ZAZOU
399



NEW

QUASAR 10
399



CALLISTO
400



NEW

DUKAN
401



NEW

STOCKHOLM
402



NEW

LIBRA
402



FRAME ROUND
MAXI
403



FRAME SQUARE
MAXI
403

ENCASTRÉS EXTÉRIEURS



NEW

JUNISTAR LUX
ISOSAFE
404



AL1014 RDX OUT
405



SPOTI R-B OUT
405

PLAFONNIERS EXTÉRIEURS

METRO

5 ANS

IP65



A++
A

230V



ANTI
CORROSION
GARANTIE
10 ANS

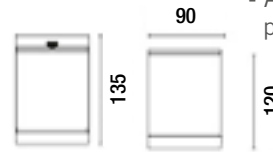

- Accès facile à la source lumineuse par ouverture magnétique

RÉF. ID	CULOT	PUISSANCE MAX	FLUX MAX	COULEUR	MATÉRIAU	PRIX HTVA
ID/00776450	GU10	MAX 9W	575 LM	● NOIR	ALUMINIUM	€ 68,00
ID/00776513	GU10	MAX 9W	575 LM	● GRAPHITE	ALUMINIUM	€ 68,00

Disponible en applique extérieure page 360

ECHO

5 ANS

IP54



A++
A

230V



ANTI
CORROSION
GARANTIE
10 ANS

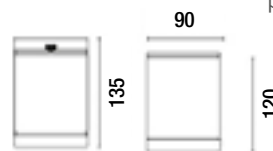

- Accès facile à la source lumineuse par ouverture magnétique

RÉF. ID	CULOT	PUISSANCE MAX	FLUX MAX	COULEUR	MATÉRIAU	PRIX HTVA
ID/00776444	GU10	MAX 9W	575 LM	● NOIR	ALUMINIUM	€ 80,00
ID/00776507	GU10	MAX 9W	575 LM	● GRAPHITE	ALUMINIUM	€ 80,00

Disponible en applique extérieure page 358

BOXY +

IP44



A++
A

230V

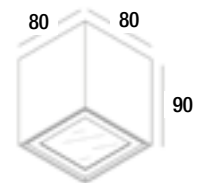

RÉF. ID	CULOT	PUISSANCE MAX	FLUX MAX	COULEUR	MATÉRIAU	PRIX HTVA
ID/00600887	GU10	MAX 9W	575 LM	○ BLANC	ALUMINIUM	€ 97,00
ID/00600885	GU10	MAX 9W	575 LM	● ALU	ALUMINIUM	€ 97,00
ID/00600886	GU10	MAX 9W	575 LM	● GRAPHITE	ALUMINIUM	€ 97,00

PLAFONNIERS EXTÉRIEURS

ZAZOU

LED IP65 IRC 80 IK10 230V

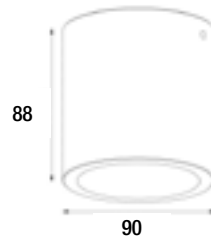

NEW

RÉF. ID	PUISSANCE	FLUX	T°	COULEUR	MATÉRIAU	PRIX HTVA
ID/03468875	6W	301 LM	3000°K	○ BLANC	ALUMINIUM	€ 55,00
ID/03468874	6W	301 LM	3000°K	● NOIR	ALUMINIUM	€ 55,00

QUASAR 10

LED 5 ANS IP40 IRC 80 230V

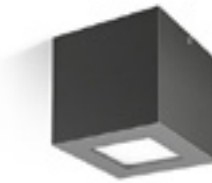
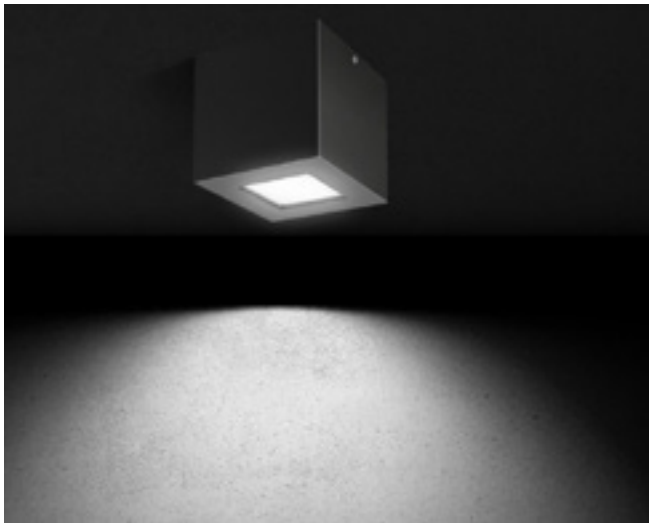

NEW

RÉF. ID	PUISSANCE	FLUX	T°	COULEUR	MATÉRIAU	PRIX HTVA
ID/02508959	4,5W	500 LM	3000°K	○ BLANC	ALUMINIUM	€ 99,00
ID/02508958	4,5W	500 LM	3000°K	● GRIS METALISE	ALUMINIUM	€ 99,00
ID/02508957	4,5W	500 LM	3000°K	● ANTHRACITE	ALUMINIUM	€ 99,00
ID/02508962	4,5W	500 LM	4000°K	○ BLANC	ALUMINIUM	€ 99,00
ID/02508961	4,5W	500 LM	4000°K	● GRIS METALISE	ALUMINIUM	€ 99,00
ID/02508960	4,5W	500 LM	4000°K	● ANTHRACITE	ALUMINIUM	€ 99,00

PLAFONNIERS ET ENCASTRÉS EXT.

Disponible en applique extérieure page 362

PLAFONNIERS EXTÉRIEURS

CALLISTO

LED 5 ANS IP65 IRC >80 TRIAC ↑ A++ A 230V 

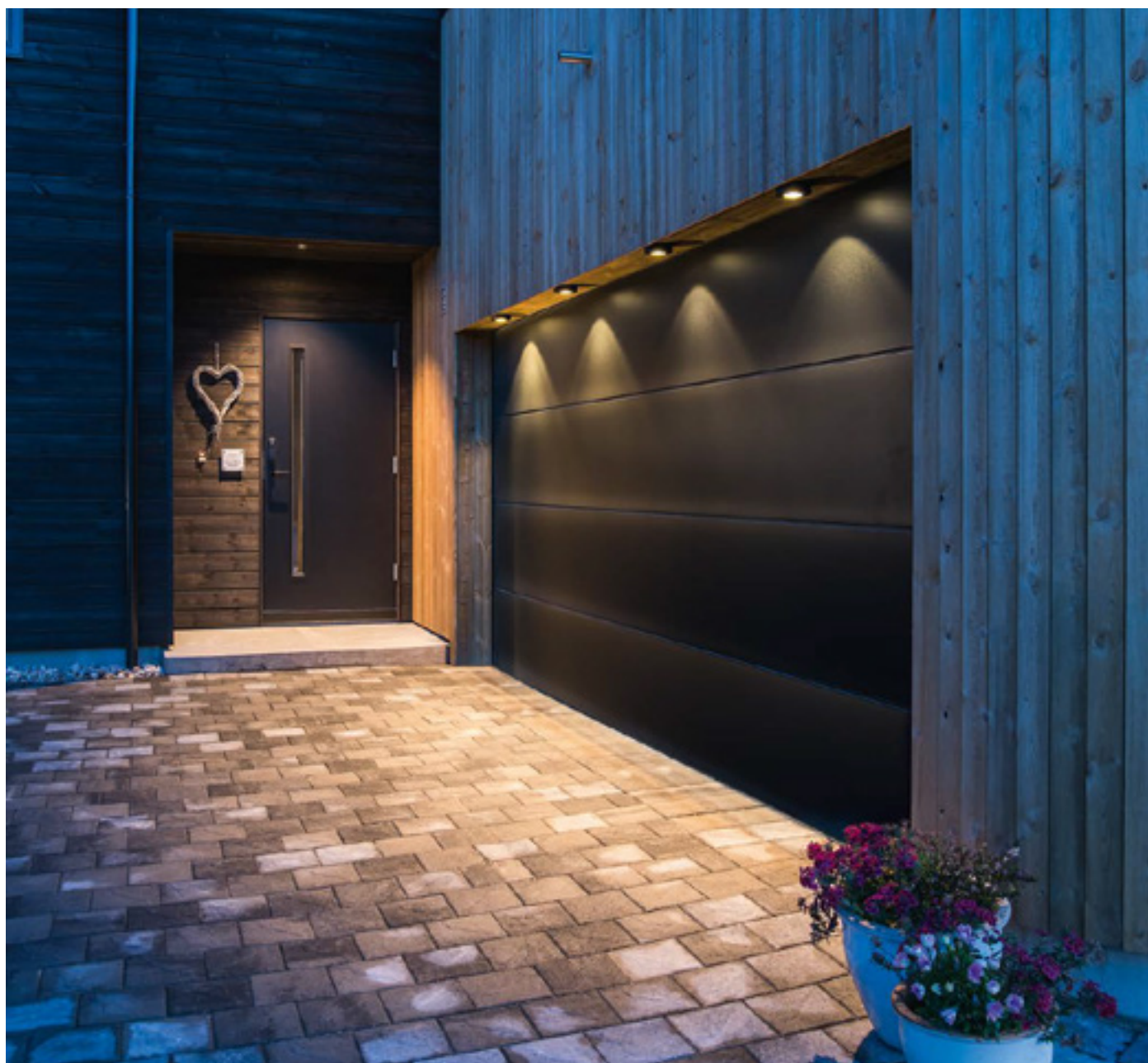

PLAFONNIERS ET ENCASTRÉS EXT.



ANTI CORROSION
GARANTIE
10 ANS

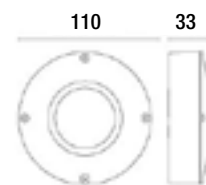

RÉF. ID	PUISSANCE	FLUX	T°	COULEUR	MATÉRIAU	PRIX HTVA
ID/02324197	4W	180 LM	3000°K	○ BLANC MAT	ALUMINIUM/ VERRE	€ 81,00
ID/02324227	4W	180 LM	3000°K	● NOIR	ALUMINIUM/ VERRE	€ 81,00
ID/02324245	4W	180 LM	3000°K	● GRAPHITE	ALUMINIUM/ VERRE	€ 81,00

Disponible en balisage extérieur page 394

PLAFONNIERS EXTÉRIEURS

DUKAN



230V

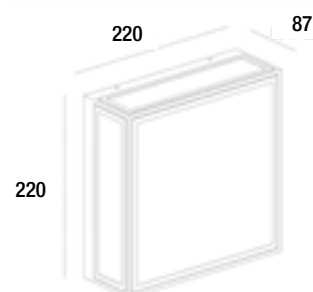

NEW

RÉF. ID	CULOT	PUISSANCE	FLUX MAX	COULEUR	MATÉRIAU	PRIX HTVA
ID/03170109	2 X E27	2 X MAX 9W	2 X 800LM	● NOIR	ALUMINIUM/VERRE	€ 76,00

Disponible en applique extérieure page 377

PLAFONNIERS ET ENCASTRÉS EXT.

PLAFONNIERS EXTÉRIEURS

STOCKHOLM

LED 3 ANS IP65 110° IRC 80 IK06 ↑ A++ A 230V

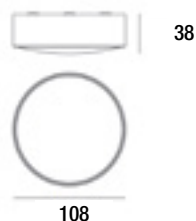

NEW

RÉF. ID	PUISSANCE	FLUX	T°	COULEUR	MATÉRIAU	PRIX HTVA
ID/03383168	6W	420 LM	3000°K	● GRIS ANTHRACITE	ALUMINIUM	€ 81,00
ID/03383169	6W	420 LM	3000°K	● NOIR STRUCTURE	ALUMINIUM	€ 81,00

LIBRA

LED IP54 IRC >80 IK10 ↑ A++ A 230V

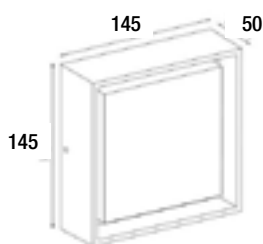

NEW

RÉF. ID	PUISSANCE	FLUX	T°	COULEUR	MATÉRIAU	PRIX HTVA
ID/03468872	10W	564 LM	3000°K	● NOIR	ALUMINIUM	€ 44,00



PLAFONNIERS ET ENCASTRÉS EXT.

PLAFONNIERS EXTÉRIEURS

FRAME ROUND MAXI

LED 5 ANS IP66 IRC >80 IK10 TRIAC ↑ ↓ A++ A 230V



- Platine LED remplaçable
- Réglable par Dip switch

Le conseil de l'éclairagiste:
Le réglage par Dip-switch permet de commander au convertisseur de fournir un ampérage plus important à la LED et d'ainsi en augmenter son flux lumineux.

RÉF. ID	PUISSANCE	FLUX	T°	COULEUR	MATÉRIAU	PRIX HTVA
ID/02628691	23 W	1960 LM	3000°K	○ BLANC	ALUMINIUM / POLYCARBONATE	€ 188,00
ID/02628701	23 W	1960 LM	3000°K	● NOIR	ALUMINIUM / POLYCARBONATE	€ 188,00
ID/02628696	23 W	1960 LM	3000°K	● GRAPHITE	ALUMINIUM / POLYCARBONATE	€ 188,00
ID/02628695	23 W	2030 LM	4000°K	○ BLANC	ALUMINIUM / POLYCARBONATE	€ 188,00
ID/02628705	23 W	2030 LM	4000°K	● NOIR	ALUMINIUM / POLYCARBONATE	€ 188,00
ID/02628700	23 W	2030 LM	4000°K	● GRAPHITE	ALUMINIUM / POLYCARBONATE	€ 188,00

Disponible avec détecteur page 299

FRAME SQUARE MAXI

LED 5 ANS IP66 IRC >80 IK10 TRIAC ↑ ↓ A++ A 230V



- Platine LED remplaçable
- Réglable par Dip switch

RÉF. ID	PUISSANCE	FLUX	T°	COULEUR	MATÉRIAU	PRIX HTVA
ID/02628718	21 W	1980 LM	3000°K	○ BLANC	ALUMINIUM / POLYCARBONATE	€ 188,00
ID/02628729	21 W	1980 LM	3000°K	● NOIR	ALUMINIUM / POLYCARBONATE	€ 188,00
ID/02628723	21 W	1980 LM	3000°K	● GRAPHITE	ALUMINIUM / POLYCARBONATE	€ 188,00
ID/02628717	21 W	2370 LM	4000°K	○ BLANC	ALUMINIUM / POLYCARBONATE	€ 188,00
ID/02628734	21 W	2370 LM	4000°K	● NOIR	ALUMINIUM / POLYCARBONATE	€ 188,00
ID/02628728	21 W	2370 LM	4000°K	● GRAPHITE	ALUMINIUM / POLYCARBONATE	€ 188,00

Disponible avec détecteur page 299

ENCASTRÉS EXTÉRIEURS

JUNISTAR LUX ISOSAFE

LED

5 ANS

IP44

30°

42°

IRC 98



TRIAC



A++ A

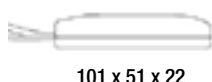
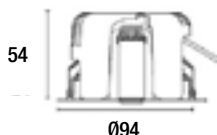

ANTI CORROSION GARANTIE 10 ANS

Junistar Lux offre une lumière harmonieuse et sans scintillement avec un excellent rendu des couleurs. Gyroscopique sur 360° (breveté) avec inclinaison sur 30°. Livré avec un nouveau boîtier de connexion offrant une meilleure résistance de traction pour plusieurs types de câbles, un plus grand espace pour les raccordements et un support pour câbles flexibles.

- Convertisseur dimmable déporté fourni
- Dimming par coupure de phase descendante
- Fixation par ressorts

NEW

RÉF. ID	PUISSANCE	FLUX	T°	COULEUR	ENCASTREMENT MM	MATÉRIAU	PRIX HTVA
ID/02949639	8W	540 LM	2700°K	○ BLANC	Ø 83	ALUMINIUM/VERRE	€ 69,00
ID/02949644	8W	470 LM	2700°K	● NOIR	Ø 83	ALUMINIUM/VERRE	€ 69,00
ID/02949636	8W	480 LM	2700°K	● GRAPHITE	Ø 83	ALUMINIUM/VERRE	€ 69,00
ID/02949640	8W	560 LM	3000°K	○ BLANC	Ø 83	ALUMINIUM/VERRE	€ 69,00
ID/02949642	8W	490 LM	3000°K	● NOIR	Ø 83	ALUMINIUM/VERRE	€ 69,00
ID/02949637	8W	500 LM	3000°K	● GRAPHITE	Ø 83	ALUMINIUM/VERRE	€ 69,00
ID/02949641	8W	620 LM	4000°K	○ BLANC	Ø 83	ALUMINIUM/VERRE	€ 69,00
ID/02949643	8W	540 LM	4000°K	● NOIR	Ø 83	ALUMINIUM/VERRE	€ 69,00
ID/02949638	8W	550 LM	4000°K	● GRAPHITE	Ø 83	ALUMINIUM/VERRE	€ 69,00

PLAFONNIERS ET ENCASTRÉS EXT.



Application maison et système domotique avec communication par Bluetooth

- Application gratuite disponible sur Google Play ou l'App Store
- Nombreuses fonctions pour piloter les tâches importantes, comme les scénarios, les minuteurs, les groupes, etc.
- SG Smart fonctionne avec l'Assistant Google et Alexa grâce à SG Smart Gateway
- Programmation et configuration les plus simples du marché, sans accessoires coûteux
- Compatible avec tous les produits SG à variation à coupure de phase

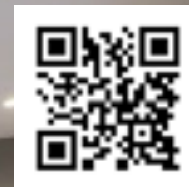
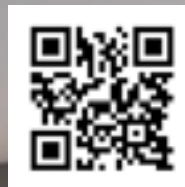

ENCASTRÉS EXTÉRIEURS

AL1014 RDX OUT



- Avec traitement de surface pour une meilleure résistance
- Fixation par ressorts

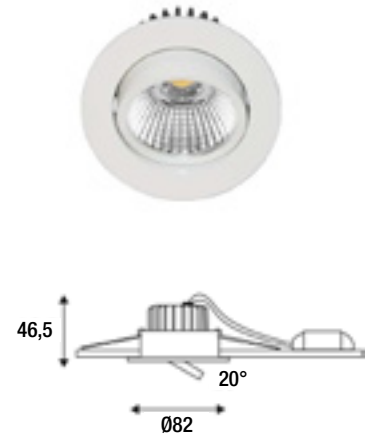

RÉF. ID	PUISSANCE	FLUX	T°	COULEUR	ENCASTREMENT MM	MATÉRIAU	PRIX HTVA
ID/02682397	9W	827 LM	3000°K	○ BLANC	Ø 68	ALUMINIUM	€ 66,00
ID/02682396	9W	827 LM	3000°K	● ANTHRACITE	Ø 68	ALUMINIUM	€ 70,00
ID/02682395	9W	869 LM	4000°K	○ BLANC	Ø 68	ALUMINIUM	€ 66,00
ID/02682394	9W	869 LM	4000°K	● ANTHRACITE	Ø 68	ALUMINIUM	€ 70,00

SPOTI R-B OUT

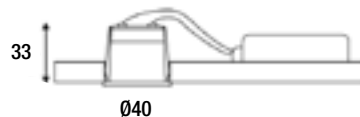

- Avec traitement de surface pour une meilleure résistance
- Précâblé 1.50m
- Double bornier automatique
- Convertisseur non dimmable déporté fourni, peut être placé à max. 10m de l'appareil
- Fixation par lamelles

RÉF. ID	PUISSANCE	FLUX	T°	COULEUR	ENCASTREMENT MM	MATÉRIAU	PRIX HTVA
ID/02682405	4,5W	443 LM	3000°K	○ BLANC	Ø 35	ALUMINIUM	€ 49,00
ID/02682404	4,5W	364 LM	3000°K	● ANTHRACITE	Ø 35	ALUMINIUM	€ 49,00
ID/02682403	4,5W	450 LM	4000°K	○ BLANC	Ø 35	ALUMINIUM	€ 49,00
ID/02682402	4,5W	374 LM	4000°K	● ANTHRACITE	Ø 35	ALUMINIUM	€ 49,00

PROJECTEURS EXTÉRIEURS

PAGES 406 À 417

Pour un luminaire qui fournit un éclairage puissant, diffus et homogène (lors de vos activités extérieures autour de la maison), mais aussi un éclairage dissuasif en cas d'intrusion dans la propriété... un seul choix: les projecteurs extérieurs.



PROJECTEURS EXTÉRIEURS



NEW LOOP III
408



NEW LOOP III
PIR
409



TENKO
410



NEW

FLOM
410



NEW

FLOM SENSOR
411



NEW

SPIDER +
412



NEW

SHARK
413

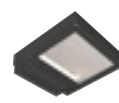

VERBIER
414



NEW

E PRO FLOOD
SENSOR
414



NEW

E PRO SPOT
SENSOR
415



NEW

SOLVELA
416



GUELL ZERO
417



NEW

LEVANTO
417

PROJECTEURS EXTÉRIEURS

NEW LOOP III

LED 3 ANS IP65 IRC 70   A+ 230V 



- Peinture par poudrage
- Protection contre les surtensions 4 kv
- Verre anti éblouissement

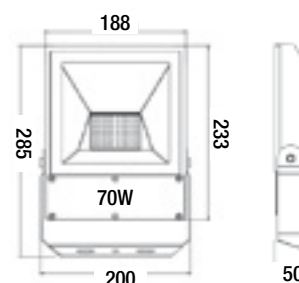

RÉF. ID	PUISSANCE	FLUX	T°	COULEUR	DIMENSIONS MM	MATÉRIAU	PRIX HTVA
ID/03128910	30W	3600 LM	3000°K	● NOIR	200 X 145 X 40	ALUMINIUM / VERRE	€ 75,00
ID/03128911	30W	3600 LM	3000°K	○ BLANC	200 X 145 X 40	ALUMINIUM / VERRE	€ 75,00
ID/03128912	30W	3900 LM	4000°K	● NOIR	200 X 145 X 40	ALUMINIUM / VERRE	€ 75,00
ID/03128913	30W	3900 LM	4000°K	○ BLANC	200 X 145 X 40	ALUMINIUM / VERRE	€ 75,00
ID/03128914	50W	6000 LM	3000°K	● NOIR	242 X 173 X 48	ALUMINIUM / VERRE	€ 95,00
ID/03128915	50W	6000 LM	3000°K	○ BLANC	242 X 173 X 48	ALUMINIUM / VERRE	€ 95,00
ID/03128916	50W	6500 LM	4000°K	● NOIR	242 X 173 X 48	ALUMINIUM / VERRE	€ 95,00
ID/03128917	50W	6500 LM	4000°K	○ BLANC	242 X 173 X 48	ALUMINIUM / VERRE	€ 95,00
ID/03128918	70W	8400 LM	3000°K	● NOIR	285 X 200 X 50	ALUMINIUM / VERRE	€ 125,00
ID/03128919	70W	8400 LM	3000°K	○ BLANC	285 X 200 X 50	ALUMINIUM / VERRE	€ 125,00
ID/03128920	70W	9100 LM	4000°K	● NOIR	285 X 200 X 50	ALUMINIUM / VERRE	€ 125,00
ID/03128921	70W	9100 LM	4000°K	○ BLANC	285 X 200 X 50	ALUMINIUM / VERRE	€ 125,00

PROJECTEURS EXTÉRIEURS

NEW LOOP III PIR

LED IP65 IRC 80  ← A+ 230V 



TÉLÉCOMMANDE
DE RÉGLAGE
INCLUDE

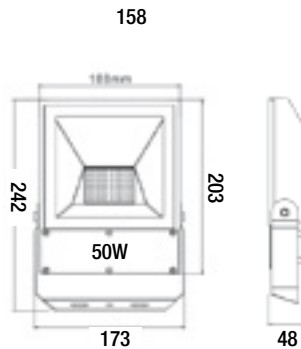

- Détecteur de mouvement totalement intégré au projecteur
- Réglage de la sensibilité crépusculaire par : 5, 15, 30, 50, 100 lux ou permanent
- Temporisation réglable de 5 secondes jusqu'à 30 minutes
- Distance de détection : 5 mètres
- Angle d'ouverture : 120°

Le conseil de l'éclairagiste:

Vous souhaitez pouvoir modifier les paramètres de votre détecteur sans devoir prendre une échelle ? Optez pour un détecteur avec télécommande.

RÉF. ID	PUISSANCE	FLUX	T°	COULEUR	DIMENSIONS MM	MATÉRIAU	PRIX HTVA
ID/02736918	10 W	1050 LM	4000°K	● NOIR	165 X 115 X 32	ALUMINIUM / VERRE	€ 69,00
ID/02846154	10 W	1050 LM	4000°K	○ BLANC	165 X 115 X 32	ALUMINIUM / VERRE	€ 69,00
ID/02736919	30 W	3150 LM	4000°K	● NOIR	200 X 145 X 40	ALUMINIUM / VERRE	€ 85,00
ID/02846155	30 W	3150 LM	4000°K	○ BLANC	200 X 145 X 40	ALUMINIUM / VERRE	€ 85,00
ID/03128928	50 W	5500 LM	4000°K	● NOIR	242 X 173 X 48	ALUMINIUM / VERRE	€ 127,00
ID/03128929	50 W	5500 LM	4000°K	○ BLANC	242 X 173 X 48	ALUMINIUM / VERRE	€ 127,00

ACCESSOIRES POUR NEW LOOP



RÉF. ID	ACCESSOIRES	COULEUR	PRIX HTVA
ID/01784793	PIQUET 16CM	● NOIR	€ 8,00
ID/01784794	PIQUET 25CM	● NOIR	€ 9,00
ID/01784790	BRAS DEPORTE DE 50CM	● ALU	€ 47,00
ID/01784791	BRAS DEPORTE DE 50CM	● NOIR	€ 47,00
ID/01784795	TETE DE MAT POUR PROJECTEUR 30/50/70W	● ALU	€ 57,00
ID/01784796	TETE DE MAT POUR PROJECTEUR 30/50/70W	● NOIR	€ 57,00

PROJECTEURS EXTÉRIEURS

TENKO

LED IP66 IRC >80 IK08 ← A+ 230V



RÉF. ID	PUISSANCE	FLUX	T°	COULEUR	DIMENSIONS MM	MATÉRIAU	PRIX HTVA
ID/02777702	20W	1950 LM	4000°K	● NOIR	144 X 156 X 45	ALUMINIUM / VERRE	€ 27,00
ID/02777703	30W	3000 LM	4000°K	● NOIR	174 X 184 X 49	ALUMINIUM / VERRE	€ 44,00
ID/02777704	50W	5200 LM	4000°K	● NOIR	233 X 242 X 60	ALUMINIUM / VERRE	€ 56,00
ID/02777705	100W	10000 LM	4000°K	● NOIR	274 X 284 X 65	ALUMINIUM / VERRE	€ 139,00
ID/02777706	150W	15000 LM	4000°K	● NOIR	304 X 315 X 78	ALUMINIUM / VERRE	€ 209,00
ID/03351984	200W	22000 LM	4000°K	● NOIR	345 X 355 X 94	ALUMINIUM / VERRE	€ 249,00

FLOM

LED 5 ANS IP65 90° 100° IRC 80 IK06 ← A++ A 230V

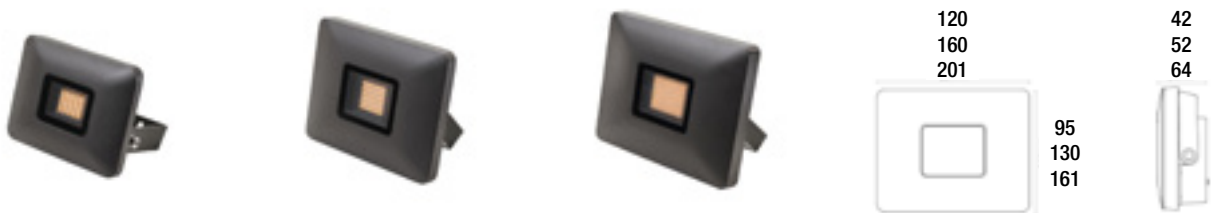

RÉF. ID	PUISSANCE	FLUX	T°	COULEUR	DIMENSIONS MM	MATÉRIAU	PRIX HTVA
ID/03298608	10W	1060 LM	3000°K	● GRAPHITE	120 X 95 X 42	ALUMINIUM/POLYCARBONATE	€ 42,00
ID/03298610	10W	1140 LM	4000°K	● GRAPHITE	120 X 95 X 42	ALUMINIUM/POLYCARBONATE	€ 42,00
ID/03298604	23W	2610 LM	3000°K	● GRAPHITE	160 X 130 X 52	ALUMINIUM/POLYCARBONATE	€ 67,00
ID/03298606	23W	2710 LM	4000°K	● GRAPHITE	160 X 130 X 52	ALUMINIUM/POLYCARBONATE	€ 67,00
ID/03298601	42W	4640 LM	3000°K	● GRAPHITE	201 X 161 X 64	ALUMINIUM/POLYCARBONATE	€ 100,00
ID/03298603	42W	4980 LM	4000°K	● GRAPHITE	201 X 161 X 64	ALUMINIUM/POLYCARBONATE	€ 100,00

NEW

PROJECTEURS EXTÉRIEURS

FLOM SENSOR

LED 5 ANS IP65 90° 100° IRC 80 IK06 A++ A 230V



120
160
201



95
130
161

42
52
64



NEW

RÉF. ID	PUISSANCE	FLUX	T°	TEMPORISATION	PORTÉE	COULEUR	DIMENSIONS MM	MATÉRIAU	PRIX HTVA
ID/03298609	10W	1060 LM	3000°K	5 S - 5 MIN	2 - 6M	● GRAPHITE	120 X 95 X 42	ALUMINIUM/ POLYCARBONATE	€ 64,00
ID/03298611	10W	1140 LM	4000°K	5 S - 5 MIN	2 - 6M	● GRAPHITE	120 X 95 X 42	ALUMINIUM/ POLYCARBONATE	€ 64,00
ID/03298605	23W	2610 LM	3000°K	5 S - 5 MIN	2 - 6M	● GRAPHITE	160 X 130 X 52	ALUMINIUM/ POLYCARBONATE	€ 90,00
ID/03298607	23W	2710 LM	4000°K	5 S - 5 MIN	2 - 6M	● GRAPHITE	160 X 130 X 52	ALUMINIUM/ POLYCARBONATE	€ 90,00
ID/03298602	42W	4640 LM	3000°K	5 S - 5 MIN	2 - 6M	● GRAPHITE	201 X 161 X 64	ALUMINIUM/ POLYCARBONATE	€ 120,00
ID/03298600	42W	4980 LM	4000°K	5 S - 5 MIN	2 - 6M	● GRAPHITE	201 X 161 X 64	ALUMINIUM/ POLYCARBONATE	€ 120,00

PROJECTEURS EXTÉRIEURS

SPIDER +

LED 5 ANS IP67 125° IRC 80 IK06 A++ A 230V

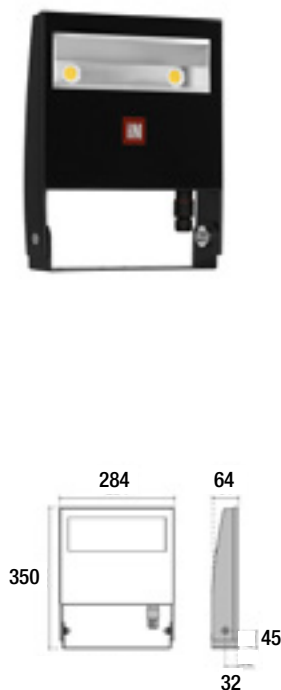

NEW

RÉF. ID	PUISSANCE	FLUX MAX	T°	COULEUR	FAISCEAU	DIMENSIONS MM	MATÉRIAU	PRIX HTVA
ID/03363090	37-51W	6677 LM	3000°K	● NOIR	SYMÉTRIQUE	350 X 64 X 164	ALUMINIUM	€ 99,00
ID/03363091	37-51W	6967 LM	4000°K	● NOIR	SYMÉTRIQUE	350 X 64 X 164	ALUMINIUM	€ 99,00
ID/03363094	74-101W	13354 LM	3000°K	● NOIR	SYMÉTRIQUE	350 X 64 X 284	ALUMINIUM	€ 179,00
ID/03363095	74-101W	13934 LM	4000°K	● NOIR	SYMÉTRIQUE	350 X 64 X 284	ALUMINIUM	€ 179,00
ID/03363088	37-51W	6677 LM	3000°K	● NOIR	ASYMÉTRIQUE	350 X 64 X 164	ALUMINIUM	€ 99,00
ID/03363089	37-51W	6967 LM	4000°K	● NOIR	ASYMÉTRIQUE	350 X 64 X 164	ALUMINIUM	€ 99,00
ID/03363092	74-101W	13354 LM	3000°K	● NOIR	ASYMÉTRIQUE	350 X 64 X 284	ALUMINIUM	€ 179,00
ID/03363093	74-101W	13934 LM	4000°K	● NOIR	ASYMÉTRIQUE	350 X 64 X 284	ALUMINIUM	€ 179,00

PROJECTEURS EXTÉRIEURS



PROJECTEURS EXTÉRIEURS

SHARK



NEW

RÉF. ID	PUISSANCE	FLUX	T°	TEMPORISATION	PORTÉE	COULEUR	DIMENSIONS MM	MATÉRIAU	PRIX HTVA
ID/03483164	10W	900 LM	2700°K	5 S - 10 MIN	2 - 12M	● NOIR	115 X 102 X 25	ALUMINIUM/ VERRE	€ 28,00
ID/03483163	10W	900 LM	6000°K	5 S - 10 MIN	2 - 12M	● NOIR	115 X 102 X 25	ALUMINIUM/ VERRE	€ 28,00
ID/03483168	20W	1800 LM	2700°K	5 S - 10 MIN	2 - 12M	● NOIR	150 X 133 X 29	ALUMINIUM/ VERRE	€ 36,00
ID/03483167	20W	1800 LM	6000°K	5 S - 10 MIN	2 - 12M	● NOIR	150 X 133 X 29	ALUMINIUM/ VERRE	€ 36,00
ID/03483172	30W	2700 LM	2700°K	5 S - 10 MIN	2 - 12M	● NOIR	180 X 157 X 32	ALUMINIUM/ VERRE	€ 43,00
ID/03483171	30W	2700 LM	6000°K	5 S - 10 MIN	2 - 12M	● NOIR	180 X 157 X 32	ALUMINIUM/ VERRE	€ 43,00
ID/03483176	50W	4500 LM	2700°K	5 S - 10 MIN	2 - 12M	● NOIR	233 X 205 X 40	ALUMINIUM/ VERRE	€ 57,00
ID/03483175	50W	4500 LM	6000°K	5 S - 10 MIN	2 - 12M	● NOIR	233 X 205 X 40	ALUMINIUM/ VERRE	€ 57,00



PROJECTEURS EXTÉRIEURS

PROJECTEURS EXTÉRIEURS

VERBIER

LED IP65 IRC >80 IK06 ← A+ 230V

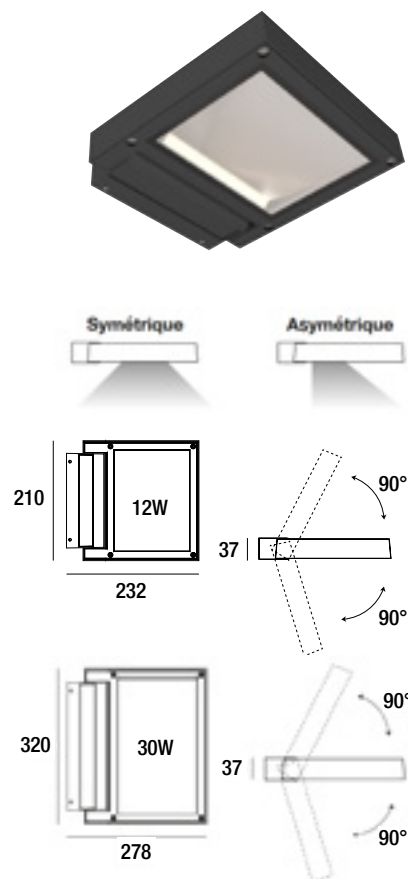

RÉF. ID	PUISSANCE	FLUX	T°	COULEUR	MATÉRIAU	OPTIQUE	PRIX HTVA
ID/02628646	12 W	1100 LM	3000°K	● ANTHRACITE	ALU	SYMÉTRIQUE	€ 129,00
ID/02628647	12 W	740 LM	3000°K	● ANTHRACITE	ALU	ASYMÉTRIQUE	€ 129,00
ID/03174642	30W	2418 LM	3000°K	● ANTHRACITE	ALU	ASYMÉTRIQUE	€ 314,00
ID/03174643	30W	2500 LM	4000°K	● ANTHRACITE	ALU	ASYMÉTRIQUE	€ 314,00

E PRO FLOOD SENSOR

LED 3 ANS IP55 100° IRC 80 IK05 ← A+ 230V

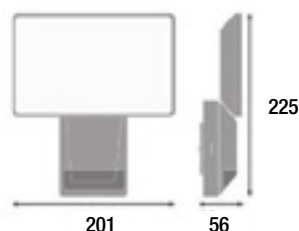

- Sélection parmi 4 modes de fonctionnement
- Angle de détection de 180°

Le conseil de l'éclairagiste:

Un spot extérieur puissant avec détecteur intégré permet autant d'éclairer une grande terrasse ou une partie importante de jardin que de participer à la sécurisation de la propriété.

RÉF. ID	PUISSANCE	FLUX	T°	TEMPORISATION	PORTÉE	COULEUR	MATÉRIAU	PRIX HTVA
ID/03223712	27W	3000 LM	4000°K	2 S - 15MIN	12M	● GRIS NOIR	POLYCARBONATE	€ 159,00

PROJECTEURS EXTÉRIEURS

E PRO SPOT SENSOR

LED 3 ANS IP55 50° IRC 80 IK05 A++ A 230V



- Sélection parmi 4 modes de fonctionnement
- Angle de détection de 180°

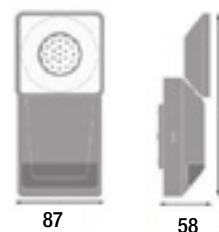

178

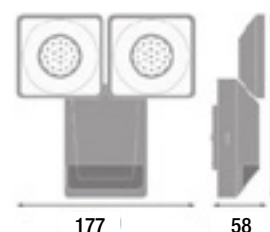

178

NEW

RÉF. ID	PUISSANCE	FLUX	T°	TEMPORISATION	PORTÉE	COULEUR	MATÉRIAU	PRIX HTVA
ID/03223714	8W	750 LM	4000°K	2 S - 15MIN	12M	● GRIS NOIR	POLYCARBONATE	€ 92,00
ID/03223716	2 X 8W	2 X 750 LM	4000°K	2 S - 15MIN	12M	● GRIS NOIR	POLYCARBONATE	€ 159,00

PROJECTEURS EXTÉRIEURS

PROJECTEURS EXTÉRIEURS

SOLVELA

LED IP65 20° 140° IRC >70

- Panneau solaire intégré
- Adaptable sur mât sur demande
- Modes et paramètres peuvent être modifiés par télécommande
- Détecteur de mouvement PIR 120°

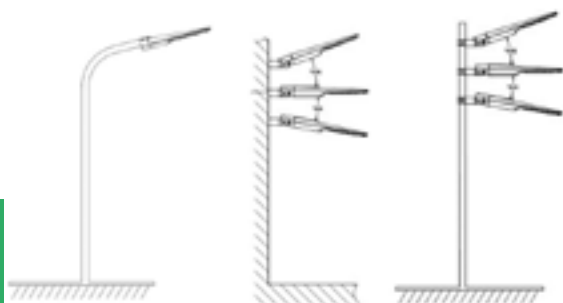
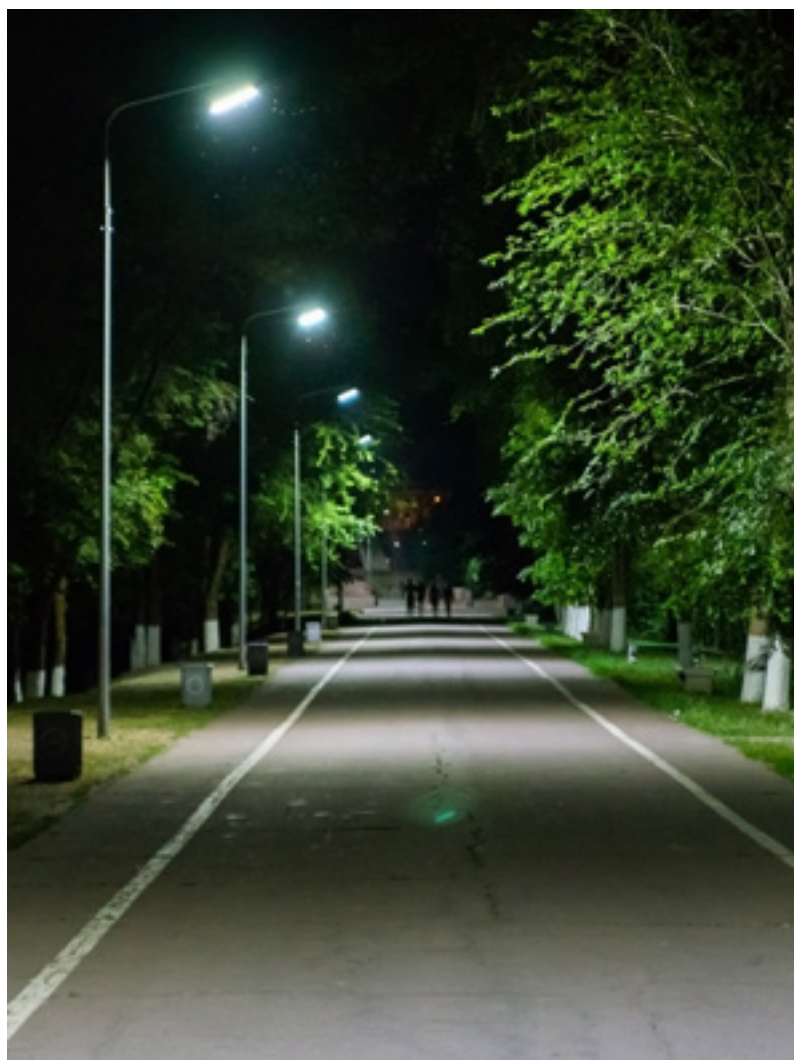

PROJECTEURS EXTÉRIEURS

NEW

RÉF. ID	PUISSANCE	FLUX	T°	COULEUR	MATÉRIAU	PRIX HTVA
ID/03481572	15W	1600 LM	4000°K	● NOIR	ABS/POLYCARBONATE	€ 89,00
ID/03471856	40W	4800 LM	4000°K	● NOIR	ABS/POLYCARBONATE	€ 299,00

PROJECTEURS EXTÉRIEURS

GUELL ZERO

LED 5 ANS IP66 IRC 80   A+ 230V 

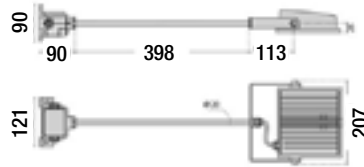

- Équipé d'1 mètre de câble H05RN-F 3G 1,5mm²
- Les versions GUELL ZERO KIT sont équipées de bras de portée de 0,5 mètre
- Boîtier de connexion intégré, prédisposé pour le raccordement en cascade

RÉF. ID	PUISSANCE	FLUX	T°	COULEUR	OPTIQUE	PRIX HTVA
ID/01706610	15 W	1484 LM	4000°K	● NOIR	SYMÉTRIQUE	€ 125,00

LEVANTO

LED 5 ANS IP66 90°   A++ A 230V 

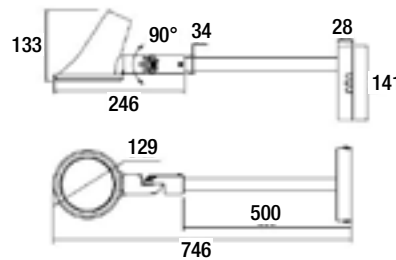

- Faisceau asymétrique 130° x 50°

NEW

RÉF. ID	PUISSANCE	FLUX	T°	COULEUR	MATÉRIAU	PRIX HTVA
ID/03546874	15W	1880 LM	3000°K	● NOIR	ALUMINIUM/INOX	€ 152,00
ID/03546875	15W	1950 LM	4000°K	● NOIR	ALUMINIUM/INOX	€ 152,00

Disponible en spot à piquer page 349



SECOURS

PAGES 418 À 427

Les luminaires de secours procurent de l'éclairage de secours quand le système normal fait défaut. Ceci peut être causé par un manquement d'énergie, par un défaut du système, ou par des causes plus sérieuses comme un incendie, la foudre ou une inondation.



BLOCS DE SECOURS



UP LED
420



AESTETICA LED
420



EURO
421



NEW
BRICK PRO
422



NEW
EXITA SWING
423



NEW
BAMBURGH SEC
424



NEW
BAMBURGH SEC
+ DET
424



CLX+ SEC +
DET
425



NEW
MOON SEC +
DET
425



NEW
PLANE MINI
426



NEW
PLANE
426



NEW
DISK
426



NEW
MEDI
427



NEW
TWIN
427

UP LED

LED IP65 IK07 230V



FAIBLE
EPAISSEUR

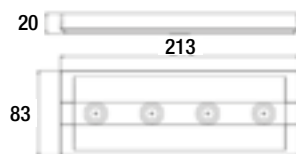

- Epaisseur: moins de 20 mm
- Corps en polycarbonate blanc
- Lentille opale polycarbonate
- Attache câble en polypropylène

RÉF. ID	PUISSANCE	AUTONOMIE	FLUX SECOURS	PERMANENT	MATÉRIAU	PRIX HTVA
ID/02116033	0,8W	1H	100 LM	NON	POLYCARBONATE	€ 36,00

AESTETICA LED

LED IP40 IK05 230V

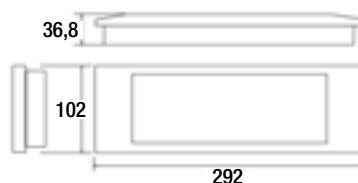







- Led à haute efficacité
- Prévu pour mur ou plafond
- Matière: plastique auto-extinguible
- Selon normes EN 60598-1, UL 94
- Indicateur led verte pour la présence réseau
- Temps de charge: 12 h

RÉF. ID	PUISSANCE	AUTONOMIE	FLUX SECOURS	PERMANENT	MATÉRIAU	PRIX HTVA
ID/00995568	8W	1H	120 LM	NON	POLYCARBONATE	€ 64,00

ACCESSOIRES POUR AESTETICA

RÉF. ID	ACCESSOIRES	PRIX HTVA
ID/02802519	KIT D'ENCASTREMENT POUR FAUX PLAFOND	€ 30,00
ID/02802518	SUPPORT DRAPEAU POUR INSTALLATION MURALE	€ 33,00
ID/02802521	PLEXI EXIT SIGN DRAPEAU BAS	€ 48,00
ID/02802520	PLEXI EXIT SIGN, DRAPEAU GAUCHE ET DROITE	€ 48,00
ID/02802276	EXIT SIGN BAS	€ 7,70
ID/02802274	EXIT SIGN DROITE	€ 7,70
ID/02802275	EXIT SIGN GAUCHE	€ 7,70

EURO

LED 5 ANS IK08      230V 

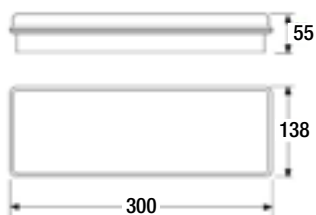







- Mode de fonctionnement permanent ou non permanent
- Système optique innovant qui offre une bonne répartition du faisceau lumineux
- Compartiment de câblage fonctionnel pour accueillir des conducteurs de 2,5 mm et prédisposé pour le câblage traversant
- Set de 4 sens de signalisation inclus
- Installation murale, plafond et encastré
- Normes : EN 60598-1, EN 60598-2-2, EN 60598-2-22, EN 1838, UNI 11222

Le conseil de l'éclairagiste:

Les modèles "permanent" ou P, sont constamment allumés, qu'il y ait de l'éclairage standard ou non. C'est d'habitude exigé dans les vestibules pour sortie de secours. Les modèles "non permanent" ou NP, sont seulement allumés lorsqu'il y a une interruption de l'énergie standard.

RÉF. ID	PUISSANCE	AUTONOMIE	FLUX SECOURS	TEST	FONCTIONNEMENT	IP	MATÉRIAU	PRIX HTVA
ID/02799458	11W	1H/3H	120/40 LM	BOUTON	P / NP	IP 42	POLYCARBONATE	€ 66,00
ID/02799459	24W	1H/3H	350/70 LM	BOUTON	P / NP	IP 42	POLYCARBONATE	€ 81,00
ID/02799460	11W	1H/3H	120/40 LM	BOUTON	P / NP	IP 65	POLYCARBONATE	€ 73,00
ID/02799461	24W	1H/3H	350/70 LM	BOUTON	P / NP	IP 65	POLYCARBONATE	€ 87,00

ACCESSOIRES POUR EURO

RÉF. ID	ACCESSOIRES	PRIX HTVA
ID/02802446	 KIT D'ENCASTREMENT POUR FAUX PLAFOND	€ 13,90
ID/03503945	 GRILLE DE PROTECTION	€ 36,00
ID/03503778	 ATTACHES DE SUSPENSION	€ 6,60
ID/03503732	 BOÎTIER IP65	€ 9,50
ID/02802495	 EXIT SIGN GAUCHE/DROITE	€ 45,00
ID/02802497	 EXIT SIGN HAUT	€ 45,00
ID/02802496	 EXIT SIGN BAS	€ 45,00

BRICK PRO

LED 5 ANS IP65 120° IRC 80 IK10   A++ A 230V  









- Eclairage de sécurité apparent
- Installation murale ou plafonnier
- Batterie intégrée
- Autotest
- Témoin lumineux
- Set de 4 sens de signalisation inclus
- Normes 60598-2-22, 62034:02012, DIN/EN 50172, ISO 7010

NEW

RÉF. ID	PUISSANCE	AUTONOMIE	FLUX SECOURS	T°	TEST	PERMANENT	MATÉRIAU	PRIX HTVA
ID/03472895	3W	3H	320 LM	4000°K	AUTOTEST	NON	POLYCARBONATE	€ 75,00

ACCESSOIRES POUR BRICK PRO

RÉF. ID	ACCESSOIRES	PRIX HTVA
ID/03472891	 CADRE D'ENCASTREMENT	€ 9,90
ID/03472892	 DIFFUSEUR TRAPEZOIDALE AVANT/ARRIÈRE	€ 12,90
ID/03472896	 SET D'AUTOCOLLANTS SENS DE SIGNALISATION VERS LE HAUT	€ 3,90
ID/03472894	 SET D'AUTOCOLLANTS SENS DE SIGNALISATION VERS LE BAS	€ 3,90
ID/03472893	 SET D'AUTOCOLLANT SENS DE SIGNALISATION VERS LA GAUCHE ET LA DROITE	€ 3,90
ID/03472898	 TELECOMMANDE IR	€ 8,90

EXITA SWING

LED 3 ANS IP20 IRC 80     230V 

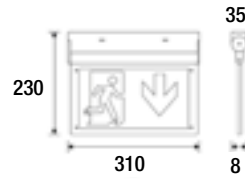

- Eclairage de sécurité apparent
- Support pivotant à 90° pour installation murale ou plafonnier
- Surface acrylique éclairée
- Batterie intégrée
- Autotest
- Témoin lumineux
- Set de 4 sens de signalisation inclus
- Normes 60598-2-22, 62034:02012, DIN/EN 50172, ISO 7010

NEW

RÉF. ID	PUISSANCE	AUTONOMIE	FLUX SECOURS	T°	TEST	PERMANENT	MATÉRIAU	PRIX HTVA
ID/03472904	3W	3H	140 LM	5800°K	AUTOTEST	NON	POLYCARBONATE	€ 73,00

ACCESSOIRE POUR EXITA SWING

RÉF. ID	ACCESSOIRES	PRIX HTVA
ID/03472905	 SET DE 4 SENS DE SIGNALISATION + BLANC	€ 8,90



BAMBURGH SEC

LED 5 ANS IP65 120° IRC 80 IK06 A++ A 230V

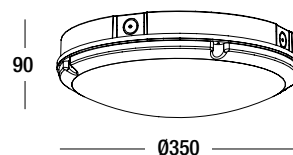
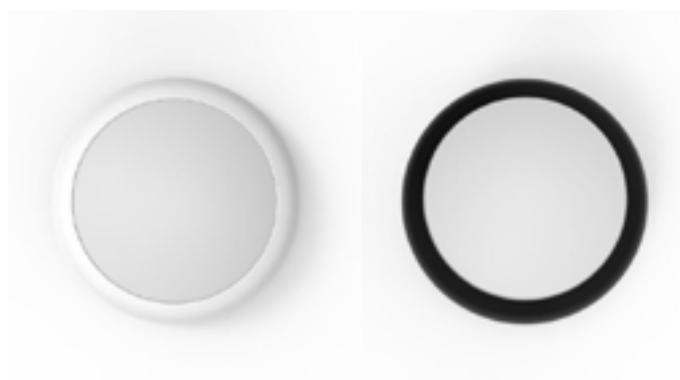

NEW

RÉF. ID	PUISSANCE	AUTONOMIE	FLUX PERMANENT	T°	COULEUR	PERMANENT	MATÉRIAU	PRIX HTVA
ID/03473173	12W	3H	1470 LM	4000°K	○ BLANC	OUI	ABS	€ 93,00
ID/03473181	12W	3H	1330 LM	4000°K	● NOIR	OUI	ABS	€ 93,00
ID/03473177	18W	3H	2100 LM	4000°K	○ BLANC	OUI	ABS	€ 111,00
ID/03473185	18W	3H	1900 LM	4000°K	● NOIR	OUI	ABS	€ 111,00

Disponible sans détecteur page 102
Disponible avec détecteur page 292

BAMBURGH SEC + DET

LED 5 ANS IP65 120° IRC 80 IK06 A++ A 230V

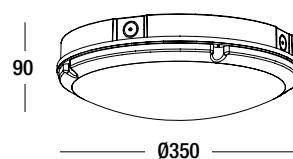
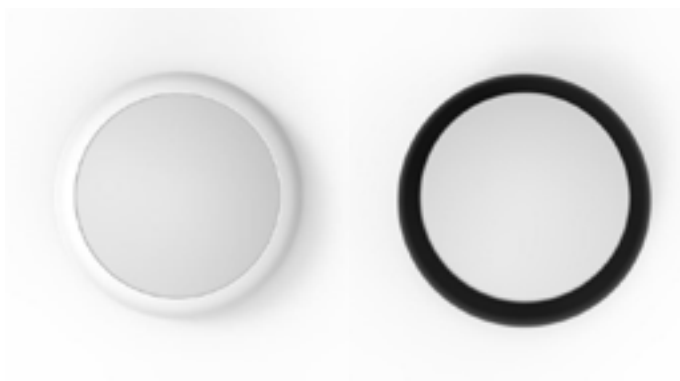

NEW

RÉF. ID	PUISSANCE	AUTONOMIE	FLUX PERMANENT	T°	COULEUR	PERMANENT	MATÉRIAU	PRIX HTVA
ID/03473175	12W	3H	1470 LM	4000°K	○ BLANC	OUI	ABS	€ 106,00
ID/03473183	12W	3H	1330 LM	4000°K	● NOIR	OUI	ABS	€ 106,00
ID/03473179	18W	3H	2100 LM	4000°K	○ BLANC	OUI	ABS	€ 127,00
ID/03473187	18W	3H	1900 LM	4000°K	● NOIR	OUI	ABS	€ 127,00

Disponible sans détecteur page 102
Disponible avec détecteur page 292

CLX+ SEC + DET



- Boîtier, cercle et diffuseur technopolymère
- Joints en silicone anti-âge
- Détecteur HF
- Réglage de la température de couleur de la LED à 3000°K ou 4000°K par Dip switch

RÉF. ID	PUISSANCE	AUTONOMIE	FLUX PERMANENT	T°	COULEUR	DIMENSIONS MM	PRIX HTVA
ID/02731369	14,5W	3H	1610 LM	3000°K - 4000°K	○ BLANC	Ø 300 X 84	€ 169,00

Disponible sans détecteur page 103
Disponible avec détecteur page 294

MOON SEC + DET

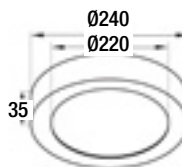

NEW

RÉF. ID	PUISSANCE	AUTONOMIE	FLUX PERMANENT	FLUX SECOURS	T°	COULEUR	TEST	PERMANENT	MATÉRIAU	PRIX HTVA
ID/02877019	18W	3H	1600 LM	350 LM	3000°K	○ BLANC	BOUTON	OUI	ALUMINIUM	€ 162,00
ID/02877020	18W	3H	1600 LM	350 LM	3000°K	● NOIR	BOUTON	OUI	ALUMINIUM	€ 162,00

Disponible avec détecteur page 294



PLANE MINI

LED 5 ANS IP20 IRC 80 IK06 230V

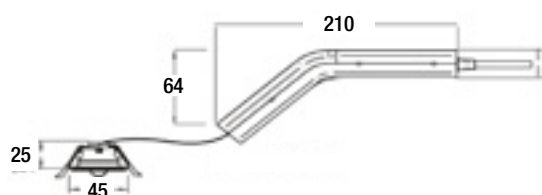

- Eclairage de sécurité encastré
- Version Mini Downlight
- Batterie angulaire pour facilité d'intégration
- Angle large de 155° ou angle de 2 x 45° asymétrique pour une application « couloir »
- Autotest
- Témoin lumineux
- Normes 60598-2-22, 62034 :02012, DIN/EN 50172

NEW

RÉF. ID	PUISSANCE	AUTONOMIE	FLUX SECOURS	T°	ENCASTREMENT MM	FAISCEAU	TEST	PERMANENT	MATÉRIAU	PRIX HTVA
ID/03472901	2W	3H	150 LM	4000°K	Ø 35	155°	AUTOTEST	NON	POLYCARBONATE	€ 40,00
ID/03472900	2W	3H	150 LM	4000°K	Ø 35	2 X 45°	AUTOTEST	NON	POLYCARBONATE	€ 40,00

PLANE

LED 5 ANS IP20 155° IRC 80 IK06 230V

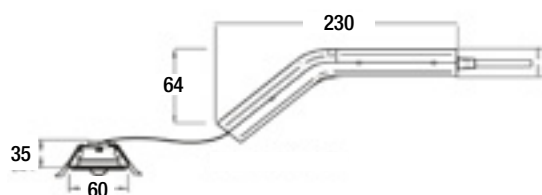

- Eclairage de sécurité encastré
- Version Downlight
- Batterie angulaire pour facilité d'intégration
- Angle large de 155°
- Autotest
- Témoin lumineux
- Normes 60598-2-22, 62034 :02012, DIN/EN 50172

NEW

RÉF. ID	PUISSANCE	AUTONOMIE	FLUX SECOURS	T°	ENCASTREMENT MM	TEST	PERMANENT	MATÉRIAU	PRIX HTVA
ID/03472899	3W	3H	270 LM	4000°K	Ø43-48	AUTOTEST	NON	POLYCARBONATE	€ 73,00

DISK

LED 5 ANS IP20 155° IRC 80 IK06 230V

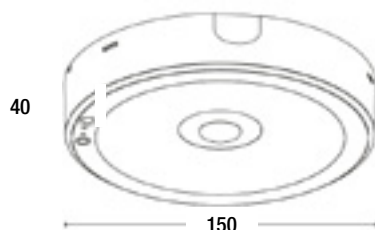

- Eclairage de sécurité apparent
- Version Downlight
- Batterie intégrée
- Angle large de 155°
- Autotest
- Témoin lumineux
- Normes 60598-2-22, 62034 :02012, DIN/EN 50172

NEW

RÉF. ID	PUISSANCE	AUTONOMIE	FLUX SECOURS	T°	TEST	PERMANENT	MATÉRIAU	PRIX HTVA
ID/03472897	3W	3H	270 LM	4000°K	AUTOTEST	NON	POLYCARBONATE	€ 73,00

TÉLÉCOMMANDE PLANE & DISK



Commande infrarouge pour test manuel, test batterie et test on/off

Le conseil de l'éclairagiste:

Une télécommande de test pour luminaires de secours facilite les contrôles incendie.

NEW

RÉF. ID	COMPATIBILITÉ	PRIX HTVA
ID/03472898	PLANE MINI - PLANE - DISK - BRICK PRO	€ 8,90

MEDI

LED 3 ANS IP20 30° IRC 80 IK06 A++ A 230V

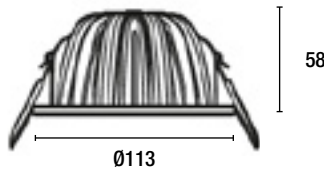

- Eclairage de sécurité encastré
- Version Downlight
- Batterie déportée incluse
- Témoin lumineux
- Normes 60598-2-22 , DIN/EN 50172

NEW

RÉF. ID	PUISSANCE	AUTONOMIE	FLUX PERMANENT	FLUX SECOURS	T°	ENCASTREMENT MM	PERMANENT	MATÉRIAU	PRIX HTVA
ID/03471873	9W	3H	700 LM	310 LM	3000°K	Ø 100	OUI	ALUMINIUM	€ 90,00

TWIN

LED 3 ANS IP65 120° IRC 80 IK10 A++ A 230V

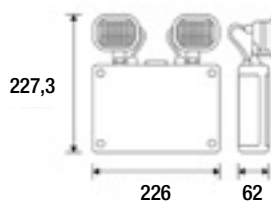

- Eclairage de sécurité apparent
- Idéal pour entrepôts, industries, cages d'escalier...
- Têtes orientables
- Batterie intégrée
- Autotest
- Témoin lumineux
- Normes 60598-2-22, 62034 :02012, DIN/EN 50172

NEW

RÉF. ID	PUISSANCE	AUTONOMIE	FLUX SECOURS	T°	TEST	PERMANENT	MATÉRIAU	PRIX HTVA
ID/03472903	2 X 1.5W	3H	2 X 175LM	4000°K	AUTOTEST	NON	POLYCARBONATE	€ 90,00

ARMATURES INDUSTRIELLES

PAGES 428 À 435

Les armatures industrielles sont destinées aux entrepôts, aux zones de stockage, de travail, d'exposition et aux halls extérieurs. Fonctionnant souvent en continu, les entrepôts logistiques et les sites industriels nécessitent un éclairage performant, minimisant à la fois la consommation énergétique et les coûts de maintenance. Ces armatures doivent également être fiables pour supporter les agressions diverses (poussière, produits chimiques, température ambiante élevée ...).



ARMATURES INDUSTRIELLES



NEW

HOLLYWOOD
430



PROPER
430



NEW

ACRO+
431



NEW

ACRO+
DETECTEUR
431



NEW

ACRO+
SECOURS
431



NEW

ATLANTE II
432



NEW

NORMA +
432



FIJI LED
433



NEW

GOLDO II
434



MILDBEAM FLAT
HIGH BAY
435

ARMATURES ÉTANCHES

HOLLYWOOD



- Corps en polycarbonate
- Diffuseur polycarbonate stabilisé aux UV
- Embouts en technopolymère
- T° de fonctionnement -15°C à 30°C
- Durée de vie 50 000h
- Sans scintillement
- Câblage traversant 5 fils

Le conseil de l'éclairagiste:

Le câblage traversant 5 fils vous permet d'alterner, sur un même circuit, les armatures hermétiques et les blocs de secours.

NEW

RÉF. ID	PUISSANCE	FLUX	T°	COULEUR	DIMENSIONS MM	MATÉRIAU	PRIX HTVA
ID/03569119	22W	2860 LM	4000°K	● GRIS	600 X 70 X 68	POLYCARBONATE	€ 42,00
ID/03569118	34W	4420 LM	4000°K	● GRIS	1200 X 70 X 68	POLYCARBONATE	€ 60,00
ID/03569117	48W	6240 LM	4000°K	● GRIS	1500 X 70 X 68	POLYCARBONATE	€ 80,00

PROPER

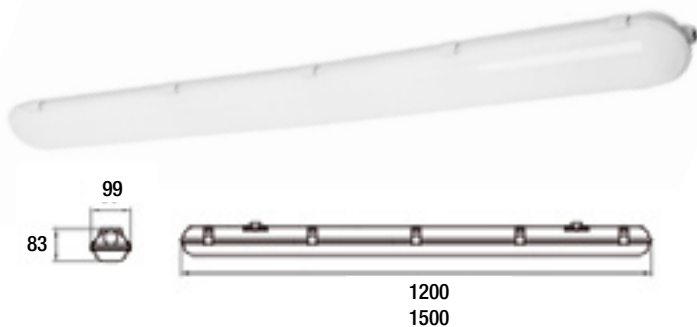

- Plafonnier à usage intérieur et extérieur
- Agrafes synthétiques anti-oxydation + 2 presse-étoupes fournis pour faciliter l'installation en série
- Fixations acier inoxydable
- Câblage traversant 3 fils
- Diffuseur opalin

RÉF. ID	PUISSANCE	FLUX	T°	COULEUR	DIMENSIONS MM	MATÉRIAU	PRIX HTVA
ID/02612654	17,7W	1404 LM	4000°K	● GRIS	600 X 80 X 73	POLYCARBONATE	€ 52,00
ID/02257529	35,6W	3550 LM	4000°K	● GRIS	1200 X 90 X 83	POLYCARBONATE	€ 60,00
ID/02257530	58W	5500 LM	4000°K	● GRIS	1500 X 90 X 83	POLYCARBONATE	€ 90,00

ARMATURES ÉTANCHES

ACRO+

LED 5 ANS IP66 IK03 IRC 80 ← ↑ A++ A 230V ← →

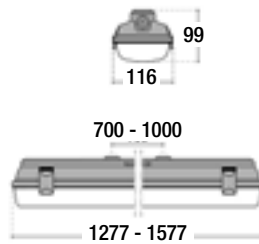

- Version multi-puissance fournie avec un Dip Switch pour sélectionner quatre niveaux de puissance, programmables lors de l'installation
- Base en polyester
- Diffuseur en PMMA opale
- Joint en silicone anti vieillissement
- Module LED multichip 4000°K
- Clips de retenue en acier inoxydable
- Étrier montage rapide au plafond (inox)
- T° de fonctionnement -25°C à 35°C
- Durée de vie 60 000h

NEW

RÉF. ID	PUISSANCE	FLUX MAX	T°	COULEUR	DIMENSIONS MM	MATÉRIAU	PRIX HTVA
ID/03544752	22 / 28 / 33 / 39W	5275 LM	4000°K	● GRIS	1277 X 116 X 99	POLYESTER/PMMA	€ 95,00
ID/03544751	27 / 34 / 41 / 47W	6794 LM	4000°K	● GRIS	1577 X 116 X 99	POLYESTER/PMMA	€ 110,00

ACRO+ DETECTEUR

LED 5 ANS IP66 IK03 IRC 80 ← ↑ A++ A 230V ← →

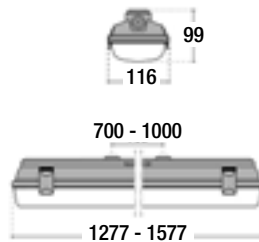

- Base en polyester
- Diffuseur en PMMA opale
- Joint en silicone anti vieillissement
- Module LED multichip 4000°K
- Clips de retenue en acier inoxydable
- Étrier montage rapide au plafond (inox)
- T° de fonctionnement -25°C à 35°C
- Durée de vie 60 000h

NEW

RÉF. ID	PUISSANCE	FLUX	T°	TEMPORISATION	PORTÉE	COULEUR	DIMENSIONS MM	MATÉRIAU	PRIX HTVA
ID/03362402	51W	5500 LM	4000°K	5 S- 15 MIN	6 M	● GRIS	1277 X 116 X 99	POLYESTER/PMMA	€ 180,00
ID/03362410	59W	6500 LM	4000°K	5 S- 15 MIN	6 M	● GRIS	1577 X 116 X 99	POLYESTER/PMMA	€ 195,00

ACRO+ SECOURS

LED 5 ANS IP66 IK03 IRC 80 ← ↑ A++ A 230V ← →

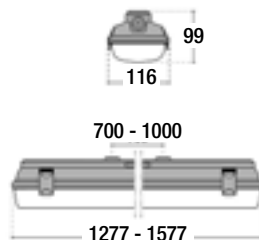

- Base en polyester
- Diffuseur en PMMA opale
- Joint en silicone anti vieillissement
- Module LED multichip 4000°K
- Clips de retenue en acier inoxydable
- Étrier montage rapide au plafond (inox)
- T° de fonctionnement 5°C à 40°C
- Durée de vie 60 000h

NEW

RÉF. ID	PUISSANCE	AUTONOMIE	FLUX PERMANENT	FLUX SECOURS	T°	COULEUR	DIMENSIONS MM	MATÉRIAU	PRIX HTVA
ID/03362401	51W	3H	5500 LM	230 LM	4000°K	● GRIS	1277 X 116 X 99	POLYESTER/PMMA	€ 245,00
ID/03362409	59W	3H	6500 LM	230 LM	4000°K	● GRIS	1577 X 116 X 99	POLYESTER/PMMA	€ 265,00

ARMATURES ÉTANCHES

ATLANTE II

LED 3 ANS IP66 170° IRC 80 IK10 A++ A 230V



- Corps en aluminium, embouts inox 304
- Diffuseur polycarbonate avec stabilisateur uv
- Clips de fermeture inox 304
- Câblage traversant 1,5mm²
- Livré avec kit de montage
- Durée de vie 50 000h
- T° de fonctionnement -15°C à 35°C
- Sans scintillement

NEW

RÉF. ID	PUISSANCE	FLUX	T°	COULEUR	DIMENSIONS MM	MATÉRIAU	PRIX HTVA
ID/03482641	19W	2600 LM	4000°K	○ OPALIN	Ø 70 X 672	ALUMINIUM/ POLYCARBONATE	€ 106,00
ID/03482645	38W	5200 LM	4000°K	○ OPALIN	Ø 70 X 1 272	ALUMINIUM/ POLYCARBONATE	€ 135,00
ID/03482649	50W	7000 LM	4000°K	○ OPALIN	Ø 70 X 1 572	ALUMINIUM/ POLYCARBONATE	€ 153,00

NORMA +

LED 5 ANS IP65 IRC 80 IK09 A++ A 230V

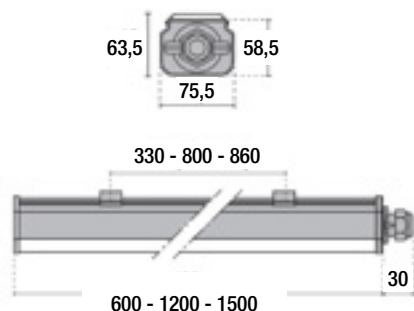

- Corps en polycarbonate stabilisé aux UV
- Embouts en technopolymère
- Joint en silicone anti vieillissement
- Douille pour le branchement électrique avec ouverture à baïonnette sans outil
- Presse-étoupe M20x1.5 pour câbles 10 - 14 mm
- Dissipateur thermique en aluminium
- Etriers pour montage rapide au plafond en inox
- Durée de vie 44 000h
- T° de fonctionnement -20°C à 45°C

NEW

RÉF. ID	PUISSANCE	FLUX	T°	COULEUR	DIMENSIONS MM	MATÉRIAU	PRIX HTVA
ID/02732247	18W	2246 LM	4000°K	● GRIS	635 X 755 X 600	POLYCARBONATE	€ 56,00
ID/02732224	34W	3932 LM	4000°K	● GRIS	635 X 755 X 1 200	POLYCARBONATE	€ 87,00
ID/02732236	60W	7556 LM	4000°K	● GRIS	635 X 755 X 1 500	POLYCARBONATE	€ 122,00

ARMATURES ÉTANCHES

FIJI LED



- Haut rendement 100lm/W
- Température de fonctionnement -40°C à +60°C
- Clips imperdables en inox
- Borne de raccordement
- Diffuseur opalin
- Détecteur de mouvements en pose apparente
- Peut être placé aussi bien sur un plafond que sur un mur.

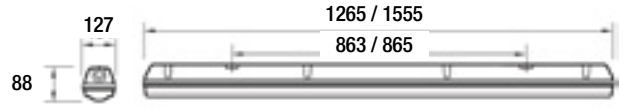

RÉF. ID	PUISSANCE	FLUX	T°	COULEUR	DIMENSIONS MM	MATÉRIAU	PRIX HTVA
ID/02609935	20W	2000 LM	4000°K	● GRIS	1265 X 127 X 88	POLYCARBONATE	€ 85,00
ID/02609937	30W	3000 LM	4000°K	● GRIS	1555 X 127 X 88	POLYCARBONATE	€ 95,00
ID/02609942	40W	4000 LM	4000°K	● GRIS	1265 X 127 X 88	POLYCARBONATE	€ 110,00
ID/02609946	60W	6000 LM	4000°K	● GRIS	1555 X 127 X 88	POLYCARBONATE	€ 130,00
ID/03582927	DÉTECTEUR DE MOUVEMENT APPARENT 220-240V ON/OFF PIR SENSOR (OPTION)						€ 55,00
ID/03582928	DÉTECTEUR DE MOUVEMENT APPARENT 0-10V DIMMING PIR SENSOR (OPTION)						€ 65,00



ARMATURES LINÉAIRES

Les armatures linéaires présentent l'avantage de proposer un grand choix d'optiques pour l'éclairage de supermarchés, zones de stockage, espace de production... Si vous devez éclairer ce type de projet, parlez-en à votre éclairagiste... ces armatures peuvent être une solution particulièrement flexible et intéressante.



CHOIX DES OPTIQUES



ARMATURES INDUSTRIELLES

GOLDO II

LED

5
ANS

IP65

120°

IRC
80

IK10

1-10V

↑

A++
A

230V

←

→



IK10

- Corps en aluminium
- Diffuseur en polycarbonate stabilisé aux UV
- Livré avec crochet de suspension
- T° de fonctionnement -35°C à 35°C
- Durée de vie 50 000h

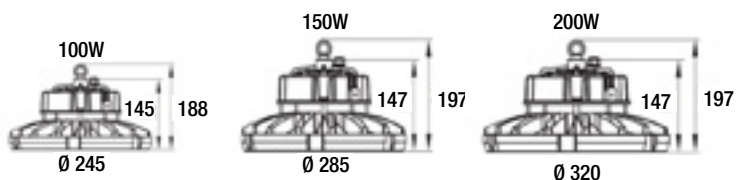

NEW

RÉF. ID	PUISSANCE	FLUX	T°	COULEUR	MATÉRIAU	PRIX HTVA
ID/03482930	100W	14000 LM	3000°K	● NOIR	ALUMINIUM	€ 190,00
ID/03482929	100W	15000 LM	4000°K	● NOIR	ALUMINIUM	€ 190,00
ID/03482925	100W	15000 LM	5000°K	● NOIR	ALUMINIUM	€ 190,00
ID/03482936	150W	21500 LM	3000°K	● NOIR	ALUMINIUM	€ 220,00
ID/03482935	150W	22500 LM	4000°K	● NOIR	ALUMINIUM	€ 220,00
ID/03482931	150W	22500 LM	5000°K	● NOIR	ALUMINIUM	€ 220,00
ID/03482942	200W	28000 LM	3000°K	● NOIR	ALUMINIUM	€ 280,00
ID/03482941	200W	30000 LM	4000°K	● NOIR	ALUMINIUM	€ 280,00
ID/03482937	200W	30000 LM	5000°K	● NOIR	ALUMINIUM	€ 280,00

MILDBEAM FLAT HIGH BAY LED 5 ANS IP65 110° IRC >70 IK10 1-10V ↑ A++ A 230V ↵ ↗

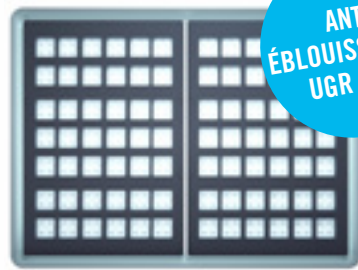

ANTI
ÉBLouisSEMENT
UGR < 19

- Température de fonctionnement -40°C à +50°C
- Durée de vie 50 000h

RÉF. ID	PUISSANCE	FLUX	T°	COULEUR	DIMENSIONS MM	MATÉRIAU	PRIX HTVA
ID/03598523	120W	19200 LM	5000°K	● ALU	415 X 310 X 120	ALUMINUM	€ 338,00
ID/03598524	200W	32000 LM	5000°K	● ALU	487 X 362 X 120	ALUMINUM	€ 463,00

Le conseil de l'éclairagiste:

Une armature anti-éblouissement augmente la concentration des employés, réduit la fatigue, protège leurs yeux et optimise leurs performances visuelles. En particulier, lors de la conduite de chariots de manutention, cette vue optimisée permet de détecter plus facilement et plus précocement des dangers potentiels.



SPOTS DE CHANTIER

PAGES 436 À 441

Pour mener à bien un chantier, il est primordial de disposer d'outils fiables et notamment de spots de chantier adaptés qui permettent d'éclairer efficacement la zone de travail. Cela facilite les tâches à accomplir tout en participant à la sécurisation du chantier et des personnes qui y travaillent.

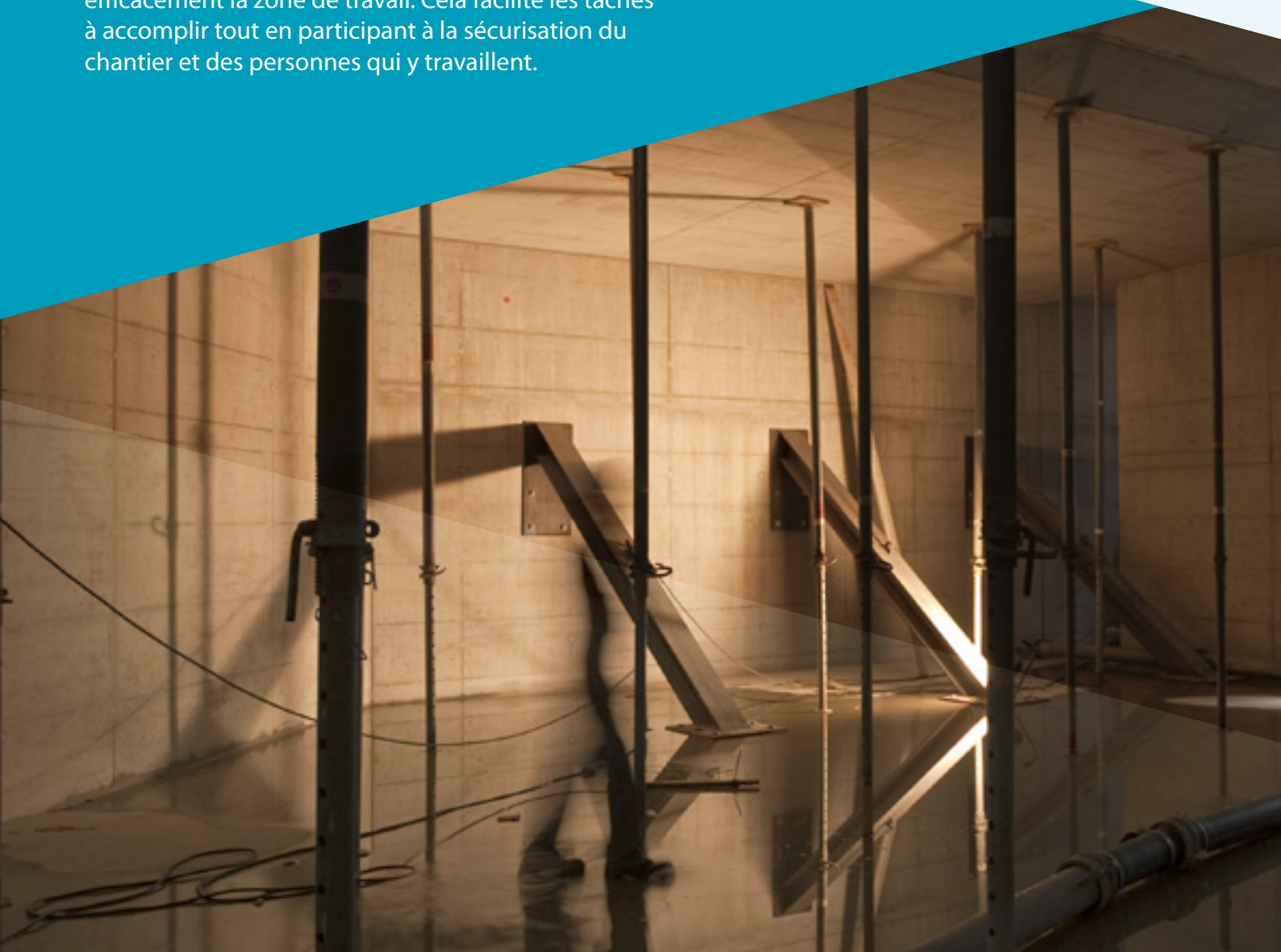

SPOTS DE CHANTIER



NEW

POCKET
438



NEW

WORK AA
438



NEW

WORK BATTERY
439



NEW

FLIP
439



NEW

ENROULED
440



NEW

POWER TUBE
440



NEW

TRÉPIED
TÉLESCOPIQUE
441

SPOTS DE CHANTIER

POCKET

LED 5 ANS IP44 A++ A



- Base magnétique
- Clip de fixation
- Câble USB inclus



NEW

RÉF. ID	PUISSANCE	FLUX	COULEUR	DIMENSIONS MM	MATÉRIAU	PRIX HTVA
ID/03468671	3W	200 LM	● BLEU/NOIR	122 X 24 X 10	METAL/SYNTHÉTIQUE	€ 23,00
ID/03468672	8W	500 LM	● BLEU/NOIR	Ø 26 X 93	METAL/SYNTHÉTIQUE	€ 30,00
ID/03468673	10W	1000 LM	● BLEU/NOIR	99 X 78 X 38	METAL/SYNTHÉTIQUE	€ 40,00

WORK AA

LED 3 ANS IP54 A++ A



- Base magnétique

NEW

RÉF. ID	PUISSANCE	FLUX	T°	COULEUR	DIMENSIONS MM	MATÉRIAU	PRIX HTVA
ID/03298304	6W	600 LM	4000°K	● BLEU/NOIR	230 X 54 X 200	METAL/SYNTHÉTIQUE	€ 26,00

WORK BATTERY

LED 5 ANS IP44 ↓ A++ A



Lampe de travail compacte rechargeable:

- Batterie: 2 x 3,7 V 2200 mAh
- Positions: 20° - 40° - 60° - 80° - 100°
- Fonction de powerbank
- Chargeur inclus

NEW

RÉF. ID	PUISSANCE	FLUX	T°	COULEUR	DIMENSIONS MM	MATÉRIAU	PRIX HTVA
ID/03298306	20W	2600 LM	6400°K	● BLEU/NOIR	170 X 47 X 170	METAL/SYNTHÉTIQUE	€ 53,00

FLIP

LED 5 ANS IP54 ↓ A++ A 230V



Sur batterie :

- Intensité variable
- Allumage de 1 ou 2 côtés
- Avec indicateur de batterie
- Fonction powerbank

Sur secteur :

- 1 prise de courant à l'arrière sur la version 2 x 20W
- 2 prises de courant à l'arrière sur la version 2 x 40W



NEW

RÉF. ID	PUISSANCE	FLUX	T°	COULEUR	DIMENSIONS MM	LONGUEUR DU CÂBLE	MATÉRIAU	PRIX HTVA
ID/03298307	2 X 10W	2 X 750 LM	6400°K	● BLEU/NOIR	186 X 115 X 280	/	METAL/SYNTHÉTIQUE	€ 93,00
ID/03298308	2 X 20W	2 X 1500 LM	6400°K	● BLEU/NOIR	184 X 140 X 280	5 M	METAL/SYNTHÉTIQUE	€ 99,00
ID/03298309	2 X 40W	2 X 2000 LM	6400°K	● BLEU/NOIR	225 X 145 X 330	5 M	METAL/SYNTHÉTIQUE	€ 165,00

SPOTS DE CHANTIER

ENROULED

LED 3 ANS IP54    230V 

- 2 prises de courant à l'arrière



NEW

RÉF. ID	PUISSANCE	FLUX	T°	COULEUR	ANGLE	DIMENSIONS MM	LONGUEUR DU CÂBLE	MATÉRIAU	PRIX HTVA
ID/03298302	10W	1000 LM	6400°K	 BLEU/NOIR	90°	490 X 370 X 29	10 M	MÉTAL/SYNTHÉTIQUE	€ 50,00
ID/03298303	20W	1800 LM	6400°K	 BLEU/NOIR	150°	565 X 305 X 35	20 M	MÉTAL/SYNTHÉTIQUE	€ 99,00

POWER TUBE

LED 5 ANS IP68 360° IK10    230V 

- Tube d'éclairage puissant pour chantier:
 - Trépied pliable le long du tube
 - Câble H07RN-F 3G2,5 de 5 Mètres
 - 2 prises de courant sur la version 65W



NEW

RÉF. ID	PUISSANCE	FLUX	COULEUR	DIMENSIONS MM	MATÉRIAU	PRIX HTVA
ID/03468676	130W	11000 LM	 BLEU/NOIR	Ø 180 X 1480	MÉTAL/SYNTHÉTIQUE	€ 231,00
ID/03468677	65W + 10W	6500 + 900 LM	 BLEU/NOIR	Ø 180 X 1240	MÉTAL/SYNTHÉTIQUE	€ 291,00

TRÉPIED TÉLESCOPIQUE POUR PROJECTEUR LED

- Hauteur ajustable de 60 à 180cm



NEW

RÉF. ID

COULEUR

MATÉRIAU

PRIX
HTVA

ID/03298305

● NOIR

MÉTAL/SYNTHÉTIQUE

€ 46,00



GESTION DE L'ÉCLAIRAGE ET ALIMENTATIONS

Un système ou un élément de gestion d'éclairage a pour fonction d'assurer la bonne quantité de lumière où il faut et quand il faut. Ils participent au confort de la maison, à la sécurité et à la réduction des coûts financiers et écologique des énergies.

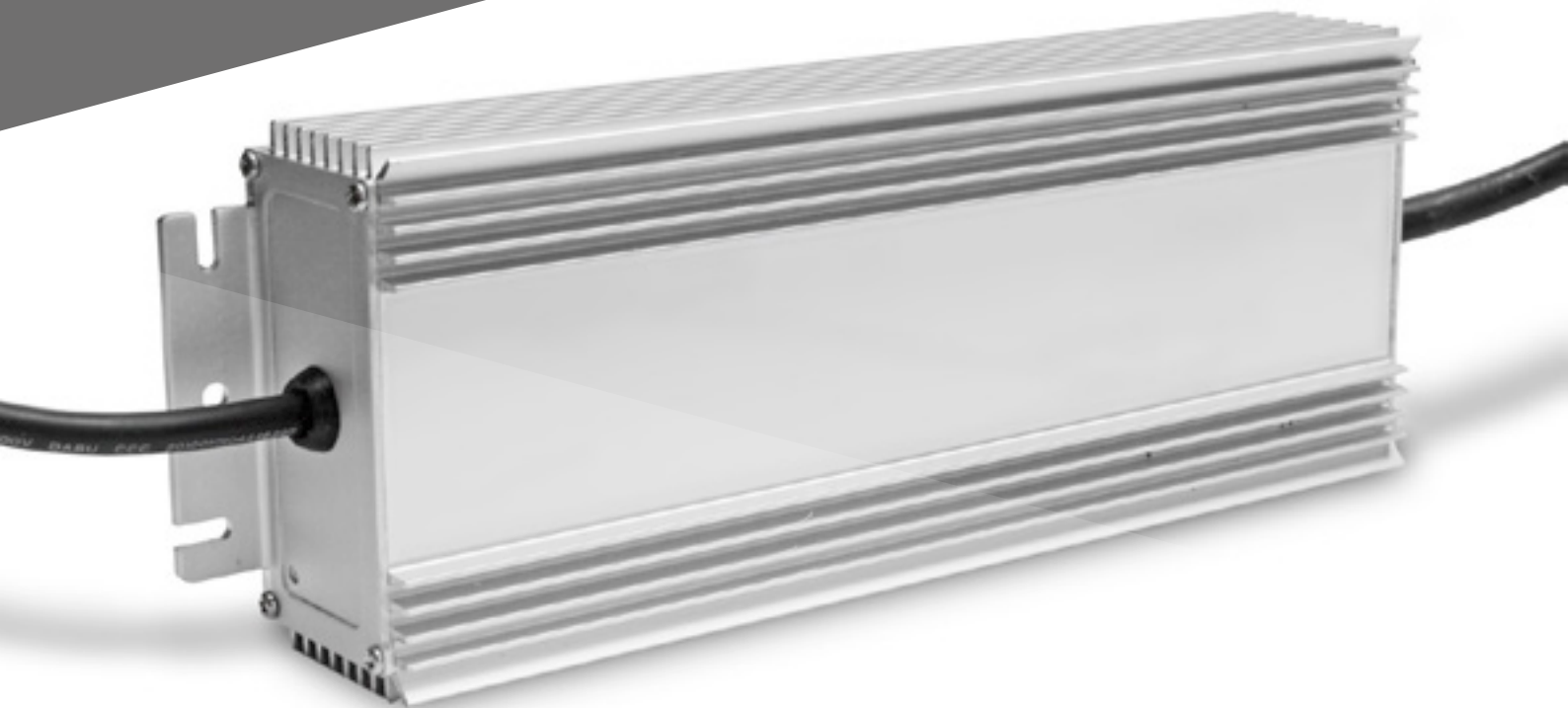

ALIMENTATIONS



24V

DC 24V
444



350mA

350mA
446



500mA

500mA
447



700mA

700mA
448

VARIATEURS



SOCLE POUR VARIATEUR À
BOUTON-POUSOIR UNIVERSEL
450



SOCLE POUR VARIATEUR À
BOUTON ROTATIF UNIVERSEL
450



SOCLE POUR VARIATEUR 1-10V
450



VARIATEUR LEDDIM À BOUTON
ROTATIF
451

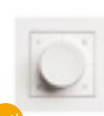

VARIATEUR LEDDIM DALI TW
451



VARIATEUR LEDDIM SMART TW
451

CONTRÔLE D'ÉCLAIRAGE SANS FIL



MODULE POUR CONTRÔLE
LUMINAIRES LED DIM. TRIAC
(220V)
452



MODULE POUR CONTRÔLE
LUMINAIRES LED 0-10V OU
DALI
452



MODULE POUR CONTRÔLE
LUMINAIRES DC24V (RUBANS
LED, ...)
453



TÉLÉCOMMANDE CASAMBI
453



CONTRÔLEUR 4 EN 1
454



RÉCEPTEUR ZIGBEE 230V
454



RECEPTEUR BLUETOOTH 230V
455



INTERRUPTEUR CAPTEUR DE
PROXIMITÉ ON - OFF
455

ALIMENTATIONS

DC 24V NON DIMMABLE

RÉF. ID	PUISSANCE	PFC	GARANTIE	IP	DIMMABLE	DIMENSIONS MM	PRIX HTVA
ID/02554254	20W		2 ANS	IP67	NON	118 X 35 X 26	€ 15,20
ID/02554255	35W		2 ANS	IP67	NON	148 X 40 X 30	€ 21,00
ID/02554256	60W		2 ANS	IP67	NON	163 X 43 X 32	€ 24,00
ID/02554252	100W		2 ANS	IP67	NON	190 X 52 X 37	€ 39,00
ID/02554253	150W		2 ANS	IP67	NON	191 X 63 X 38	€ 55,00
ID/03582930	240W	OUI	5 ANS	IP67	NON	244 X 71 X 38	€ 100,00
ID/03582933	300W	OUI	5 ANS	IP67	NON	246 X 77 X 39,5	€ 140,00
ID/02554250	480W	OUI	7 ANS	IP65	NON	262 X 125 X 44	€ 282,00
ID/03234414	600W	OUI	7 ANS	IP67	NON	280 X 144 X 48,5	€ 311,00

DC 24V DIMMABLE TRIAC

RÉF. ID	PUISSANCE	PFC	GARANTIE	IP	DIMMABLE	DIMENSIONS MM	PRIX HTVA
ID/02775877	40W		2 ANS	IP20	TRIAC	137 X 82 X 31	€ 95,00
ID/02775878	75W		2 ANS	IP20	TRIAC	213 X 54 X 33	€ 125,00
ID/02775879	150W		2 ANS	IP20	TRIAC	300 X 60 X 45	€ 162,00
ID/02775880	200W		2 ANS	IP20	TRIAC	310 X 60 X 45	€ 203,00



DC 24V DIMMABLE 1-10V

RÉF. ID	PUISSANCE	PFC	GARANTIE	IP	DIMMABLE	DIMENSIONS MM	PRIX HTVA
ID/03574640	60W		2 ANS	IP20	0-10V	190 X 65 X 22	€ 36,00
ID/03234422	60W	OUI	5 ANS	IP67	0-10V	150 X 53 X 35	€ 49,00
ID/03574644	90W		2 ANS	IP20	0-10V	190 X 65 X 22	€ 46,00
ID/03481601	90W	OUI	5 ANS	IP67	0-10V	171 X 63 X 37,5	€ 65,00
ID/03234424	120W	OUI	5 ANS	IP67	0-10V	191 X 63 X 37,5	€ 76,00
ID/01554748	150W	OUI	5 ANS	IP65	1-10V	228 X 68 X 39	€ 104,00
ID/01554750	240W	OUI	5 ANS	IP65	1-10V	250 X 90 X 44	€ 123,00
ID/02199775	320W	OUI	5 ANS	IP65	1-10V	252 X 90 X 44	€ 240,00

DC 24V DIMMABLE DALI-PUSH

RÉF. ID	PUISSANCE	PFC	GARANTIE	IP	DIMMABLE	DIMENSIONS MM	PRIX HTVA
ID/03234423	90W	OUI	5 ANS	IP67	DALI	171 X 63 X 37,5	€ 89,00
ID/02775887	200W		2 ANS	IP20	DALI - PUSH - 1-10V	310 X 60 X 45	€ 200,00

DC 24V DIMMABLE DALI - PUSH - TRIAC - 0/1-10V

RÉF. ID	PUISSANCE	PFC	GARANTIE	IP	DIMMABLE	DIMENSIONS MM	PRIX HTVA
ID/03546862	30W	OUI	2 ANS	IP20	DALI - PUSH - TRIAC 0/1-10V	170 X 50 X 38	€ 50,00
ID/03546863	100W	OUI	2 ANS	IP20	DALI - PUSH - TRIAC 0/1-10V	300 X 70 X 36	€ 164,00
ID/03546864	200W	OUI	2 ANS	IP20	DALI - PUSH - TRIAC 0/1-10V	330 X 80 X 37	€ 223,00



ALIMENTATIONS

350mA NON DIMMABLE

RÉF. ID	PUISSANCE	GARANTIE	IP	DIMMABLE	DIMENSIONS MM	PRIX HTVA
ID/02775905	3W	2 ANS	IP20	NON	86 X 32 X 23	€ 13,20
ID/02775899	7W	2 ANS	IP20	NON	47,5 X 27 X 19,8	€ 14,40
ID/02775909	9W	2 ANS	IP20	NON	86 X 32 X 23	€ 16,00
ID/02775911	15W	2 ANS	IP20	NON	96 X 36 X 23	€ 18,00
ID/02775913	21W	2 ANS	IP20	NON	96 X 36 X 23	€ 22,00
ID/02775915	24W	2 ANS	IP20	NON	135 X 36 X 25	€ 23,00

350mA DIMMABLE TRIAC

RÉF. ID	PUISSANCE	GARANTIE	IP	DIMMABLE	DIMENSIONS MM	PRIX HTVA
ID/03598519	6W	2 ANS	IP20	TRIAC	48,2 X 30 X 20	€ 18,00
ID/03576252	10W	2 ANS	IP20	TRIAC	58 X 36 X 20	€ 19,00
ID/03576254	15W	2 ANS	IP 20	TRIAC	68,2 X 36 X 23	€ 21,00

350mA DIMMABLE 0-10V

RÉF. ID	PUISSANCE	GARANTIE	IP	DIMMABLE	DIMENSIONS MM	PRIX HTVA
ID/03234385	25W	2 ANS	IP20	0-10V	105 X 68 X 23	€ 38,00
ID/03234386	40W	2 ANS	IP20	0-10V	123,5 X 81,5 X 23	€ 45,00

350mA DIMMABLE DALI-PUSH

RÉF. ID	PUISSANCE	GARANTIE	IP	DIMMABLE	DIMENSIONS MM	PRIX HTVA
ID/03234388	25W	2 ANS	IP20	DALI - PUSH	105 X 68 X 23	€ 42,00
ID/03234389	40W	2 ANS	IP20	DALI - PUSH	123,5 X 81,5 X 23	€ 51,00



500mA NON DIMMABLE

RÉF. ID	PUISSANCE	GARANTIE	IP	DIMMABLE	DIMENSIONS MM	PRIX HTVA
ID/03582932	12W	2 ANS	IP30	NON	145 X 38 X 22	€ 25,00
ID/02775927	21W	2 ANS	IP20	NON	138 X 44 X 30	€ 28,00
ID/02517909	25W	2 ANS	IP30	NON	145 X 38 X 22	€ 32,00

500mA DIMMABLE TRIAC

RÉF. ID	PUISSANCE	GARANTIE	IP	DIMMABLE	DIMENSIONS MM	PRIX HTVA
ID/03576257	6W	2 ANS	IP20	TRIAC	48,2 X 30 X 20	€ 20,00
ID/03576259	15W	2 ANS	IP20	TRIAC	68,2 X 36 X 23	€ 24,00
ID/02775947	40W	2 ANS	IP20	TRIAC	172 X 44 X 30	€ 32,00

500mA DIMMABLE 0/1-10V

RÉF. ID	PUISSANCE	GARANTIE	IP	DIMMABLE	DIMENSIONS MM	PRIX HTVA
ID/03234385	25W	2 ANS	IP20	0-10V	105 X 68 X 23	€ 38,00
ID/03234386	40W	2 ANS	IP20	0-10V	123,5 X 81,5 X 23	€ 45,00
ID/03234387	60W	2 ANS	IP20	0-10V	123,5 X 81,5 X 23	€ 50,00

500mA DIMMABLE DALI-PUSH

RÉF. ID	PUISSANCE	GARANTIE	IP	DIMMABLE	DIMENSIONS MM	PRIX HTVA
ID/03234388	25W	2 ANS	IP20	DALI - PUSH	105 X 68 X 23	€ 42,00
ID/03234389	40W	2 ANS	IP20	DALI - PUSH	123,5 X 81,5 X 23	€ 51,00
ID/03234390	60W	2 ANS	IP20	DALI - PUSH	123,5 X 81,5 X 23	€ 55,00



700mA NON DIMMABLE

RÉF. ID	PUISSANCE	GARANTIE	IP	DIMMABLE	DIMENSIONS MM	PRIX HTVA
ID/02775906	3W	2 ANS	IP20	NON	86 X 32 X 23	€ 13,20
ID/02775900	7W	2ANS	IP20	NON	47,5 X 27 X 19,8	€ 14,40
ID/02775910	11W	2 ANS	IP20	NON	86 X 32 X 23	€ 21,00
ID/02775927	30W	2 ANS	IP20	NON	138 X 44 X 30	€ 28,00
ID/02775921	40W	2 ANS	IP20	NON	135 X 36 X 25	€ 40,00

700mA DIMMABLE TRIAC

RÉF. ID	PUISSANCE	GARANTIE	IP	DIMMABLE	DIMENSIONS MM	PRIX HTVA
ID/03576253	10W	2 ANS	IP20	TRIAC	58,2 X 36 X 20	€ 19,00
ID/03576256	15W	2 ANS	IP20	TRIAC	68,2 X 36 X 23	€ 21,00

700mA DIMMABLE 0-10V

RÉF. ID	PUISSANCE	GARANTIE	IP	DIMMABLE	DIMENSIONS MM	PRIX HTVA
ID/03234385	25W	2 ANS	IP20	0-10V	105 X 68 X 23	€ 38,00
ID/03234386	40W	2 ANS	IP20	0-10V	123,5 X 81,5 X 23	€ 45,00
ID/03234387	60W	2 ANS	IP20	0-10V	123,5 X 81,5 X 23	€ 50,00



700mA DIMMABLE DALI-PUSH

RÉF. ID	PUISSANCE	GARANTIE	IP	DIMMABLE	DIMENSIONS MM	PRIX HTVA
ID/03234388	25W	2 ANS	IP20	DALI - PUSH	105 X 68 X 23	€ 42,00
ID/03234389	40W	2 ANS	IP20	DALI - PUSH	123,5 X 81,5 X 23	€ 51,00
ID/03234390	60W	2 ANS	IP20	DALI - PUSH	123,5 X 81,5 X 23	€ 55,00

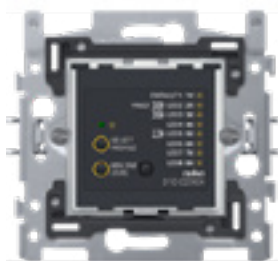

SOCLE POUR VARIATEUR À BOUTON-POUSSOIR UNIVERSEL

- Compatible LED dimmable par coupure de phase
- Adaptez l'enjoliveur de votre choix

RÉF. ID	CHARGE MINIMALE	CHARGE MAXIMALE	NOMBRE DE LED DIMMABLE MAX	PRIX HTVA
ID/02374902	3W	LED 200W HALOGÈNE 300W	10	€ 89,00

SOCLE POUR VARIATEUR À BOUTON ROTATIF UNIVERSEL



- Compatible LED dimmable par coupure de phase
- Adaptez l'enjoliveur de votre choix

RÉF. ID	CHARGE MINIMALE	CHARGE MAXIMALE	NOMBRE DE LED DIMMABLE MAX	PRIX HTVA
ID/02580734	3W	LED 200W HALOGÈNE 300W	10	€ 89,00

SOCLE POUR VARIATEUR 1-10V



- Compatible LED ou sources dimmable en 1-10V
- Adaptez l'enjoliveur de votre choix

RÉF. ID	DESCRIPTION	PRIX HTVA
ID/00616692	SOCLE POUR VARIATEUR 1-10V	€ 32,00

VARIATEUR LEDDIM À BOUTON ROTATIF

5 ANS  **230V**



- Compatible LED dimmable par coupure de phase
- Coupure bi-polaire

RÉF. ID	CHARGE MINIMALE	CHARGE MAXIMALE	NOMBRE DE LED DIMMABLE MAX	PRIX HTVA
ID/03583195	3W	LED 320W HALOGÈNE 400W	30	€ 70,00

VARIATEUR LEDDIM DALI TW

5 ANS  **230V**



- Variateur DALI pouvant régler l'intensité et la couleur
- Commande manuelle ou via l'application LEDDim
- 4 touches mémoire
- Jusqu'à 64 luminaires

NEW

RÉF. ID	DESCRIPTION	PRIX HTVA
ID/03583193	VARIATEUR LEDDIM DALI TW	€ 84,00

VARIATEUR LEDDIM SMART TW

5 ANS  **230V**



- Luminosité et couleur réglables manuellement ou via l'application
- Bluetooth intégré
- Variateur numérique à coupure de phase
- Branchement 2 phases, disjoncteur unipolaire
- Variation : 1-100 %
- 4 touches mémoire
- Charge LED 3-400 VA

NEW

RÉF. ID	DESCRIPTION	PRIX HTVA
ID/03583191	VARIATEUR LEDDIM SMART TW	€ 113,00



CONTRÔLE D'ÉCLAIRAGE SANS FIL

Casambi est un système de contrôle sans fil pour le dimming de luminaires via télécommande XPRESS ou une application sur smartphone (Bluetooth 4.0).

Il permet un dimming des luminaires 0-10V, DALI, TRIAC ou PWM (rubans LED) même lorsque le câblage existant ne le permet pas (2 fils).

Tous les détails auprès de nos conseillers techniques.

MODULE POUR CONTRÔLE LUMINAIRES LED DIM. TRIAC (220V)

- Pour LED dimmable en TRIAC

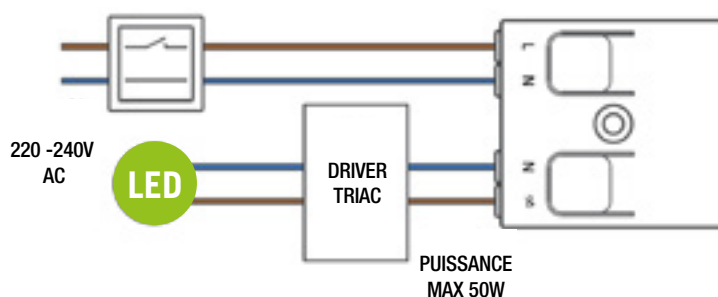

RÉF. ID	CONNEXION	SORTIE MAX.	DIMENSIONS	PRIX HTVA
ID/02778452	0,5 - 1,5MM2	LED 50W HALOGÈNE 150W	40,4 X 36,3 X 14	€ 78,00

MODULE POUR CONTRÔLE LUMINAIRES LED 0-10V OU DALI

- Pour LED dimmable en 1-10V ou DALI

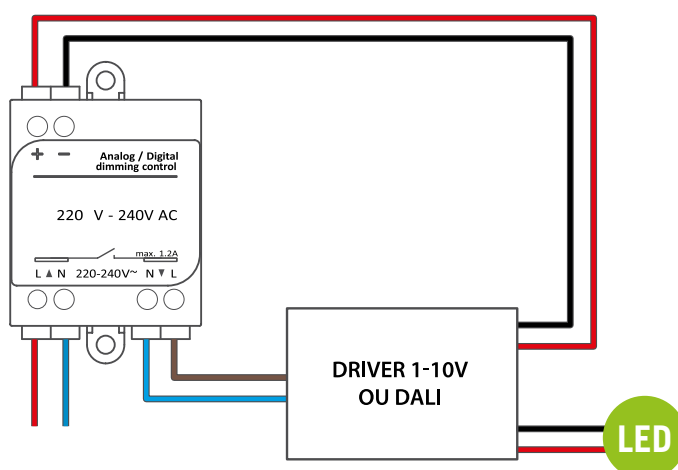

RÉF. ID	SORTIE ANALOGIQUE	SORTIE MAX.	DIMENSIONS	PRIX HTVA
ID/02778449	0-10V - DALI	LED 50W HALOGÈNE 150W	57 X 36 X 23	€ 84,00

CONTRÔLE D'ÉCLAIRAGE SANS FIL

MODULE POUR CONTRÔLE LUMINAIRES DC24V (RUBANS LED, ...)

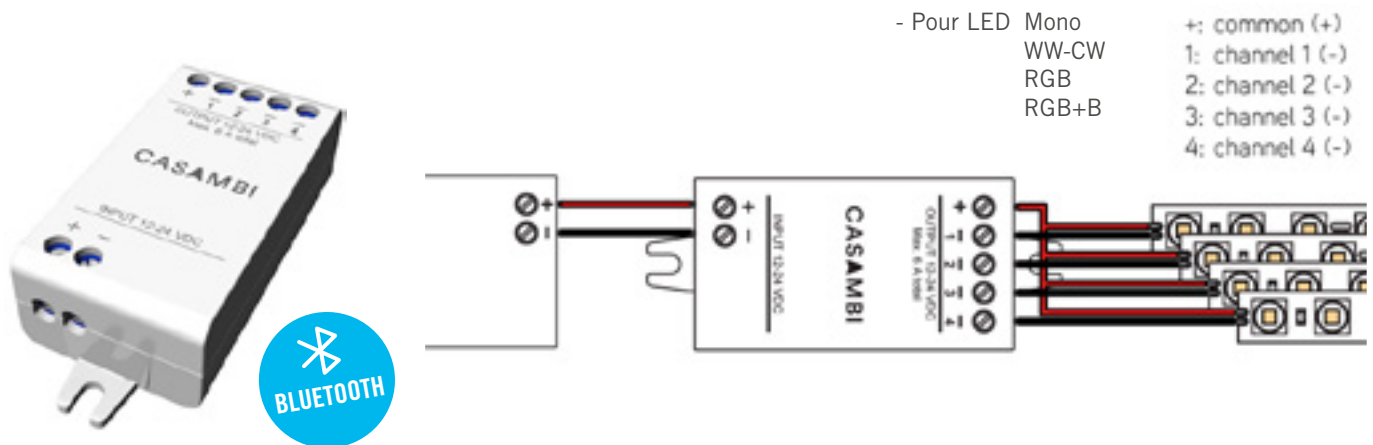

RÉF. ID	CONNEXION	ALIMENTATION	DIMENSIONS	PRIX HTVA
ID/02778451	0,75 – 1,5MM2	12V OU 24 V DC	72,6 X 30 X 18	€ 95,00

TÉLÉCOMMANDE CASAMBI



Le CASAMBI Xpress est un commutateur de lumière sans fil et une télécommande en même temps. Le Xpress apporte un degré élevé de flexibilité à la conception intérieure, puisque les meubles peuvent être librement convertis ou les murs peuvent être reconstruits sans devoir considérer le câblage pour des commutateurs légers ou leur placement.

Le commutateur peut être installé partout où l'utilisateur en a besoin et permet un accès direct à toutes les fonctions importantes de la commande d'éclairage CASAMBI.

RÉF. ID	LUMINAIRES PAR RÉSEAU INTÉGRABLE	DISTANCE	BATTERIE	DIMENSIONS	COULEUR	PRIX HTVA
ID/02778455	127 MAX	30M	CR2430 INCLUS	90 X 90 X 20	○ BLANC	€ 200,00
ID/02778456	127 MAX	30M	CR2430 INCLUS	90 X 90 X 20	● NOIR	€ 200,00



CONTRÔLE D'ÉCLAIRAGE SANS FIL

CONTRÔLEUR 4 EN 1



- À associer à un driver 24V
- Contrôleur pour rubans LED 24V
- Sélection du type de Dimming par DipSwitch
- Dimmable DALI, PUSH, 0/1-10V et TRIAC

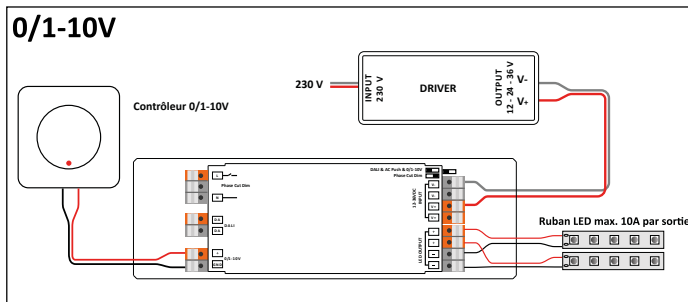
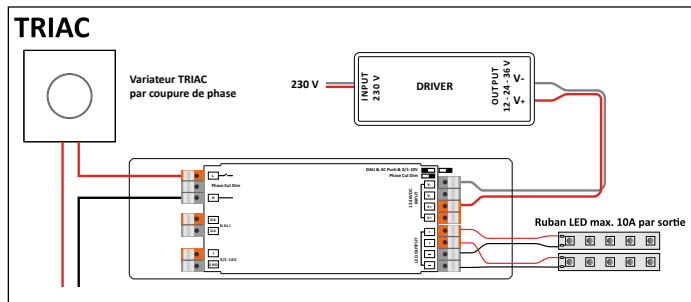
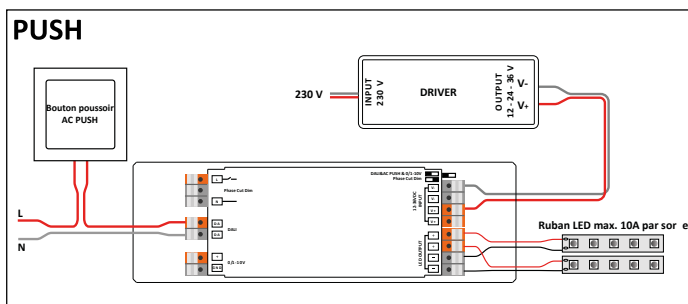
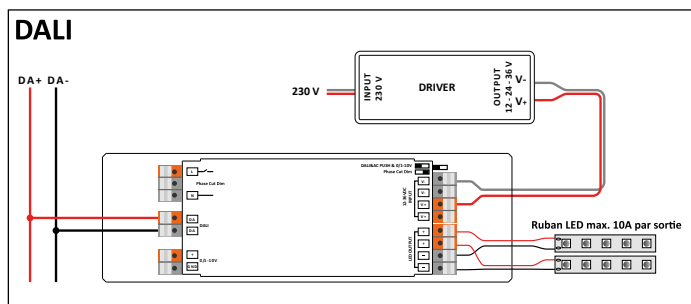

NEW

RÉF. ID	DESCRIPTION	PUISANCE MAX	ENTRÉE	SORTIE	DIMENSIONS MM	PRIX HTVA
ID/02797989	+CONVERTISSEUR 4EN1 24V DALI/PUSH/1-10V/TRIAC	480W	24V	24V	28 X 54 X 170	€ 116,00

RÉCEPTEUR ZIGBEE 230V

5 ANS IP20 230V



- Compatible avec bouton-poussoir universel
- Compatible avec télécommandes et contrôleurs mono couleur ZigBee. p.36-37
- Variation/interrupteur ON/OFF compatible lampe incandescente, halogène ou alimentation dimmable
- Dimension minimum pour installation dans une boîte d'encastrement standard de 86 x 86 mm
- Fonctionne avec 3 fils avec neutre

Variateur :

- Variation par coupure de phase TRIAC (début et fin de phase)
- Possibilité de régler la luminosité minimum
- + d'infos sur Zigbee voir p.36

RÉF. ID	PUISANCE MAX	ENTRÉE	SORTIE	VARIABLE	DIMENSIONS MM	PRIX HTVA
ID/03129069	400 W	230VAC	230VAC	NON	46 X 45 X 20	€ 61,00
ID/03129068	400 W	230VAC	230VAC	TRIAC	46 X 45 X 20	€ 70,00

CONTRÔLE D'ÉCLAIRAGE SANS FIL

RECEPTEUR BLUETOOTH 230V



230V



Variation par coupure de phase TRIAC (début et fin de phase). Possibilité de régler la luminosité minimum. Compatible avec contrôleur mono couleur Bluetooth (voir p.34). Contrôlez via smartphone (app gratuite) ou via simple bouton poussoir. Variation/interrupteur ON/OFF pour traditionnel, lampe LED incandescente ou halogène. Dimension minimum pour installation dans une boîte d'encastrement standard.

NEW

RÉF. ID	DESCRIPTION	PUISSANCE MAX	ENTRÉE	SORTIE	DIMENSIONS MM	PRIX HTVA
ID/03546960	BLUETOOTH RECEPTEUR (DIMMABLE BLUETOOTH/PUSH SANS NEUTRE)	200 W	100-240V	1,8 A	20,3 X 45 X 45,5	€ 96,00
ID/03546959	BLUETOOTH RECEPTEUR (DIMMABLE BLUETOOTH/PUSH AVEC NEUTRE)	200W	100-240V	1,8 A	20,3 X 45 X 45,5	€ 70,00

EASYTHINGS APPLICATION BLUETOOTH

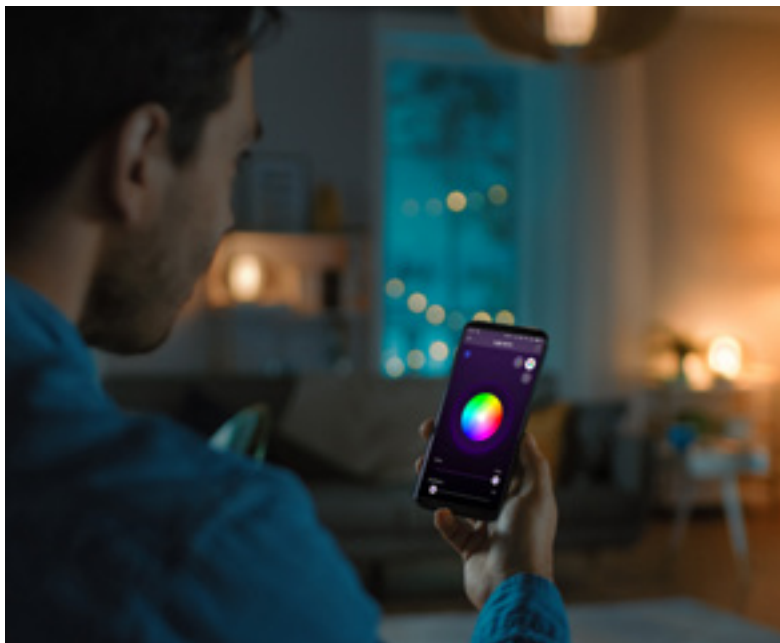

- Variation RGB, température de couleur, luminosité, on/off
- Création de groupes de luminaires
- Création de scènes
- Programmation des allumages

EASYTHINGS

Application téléchargeable sur :



INTERRUPTEUR CAPTEUR DE PROXIMITÉ ON - OFF

3 ANS

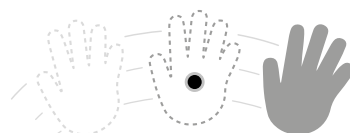

- Passer devant la cellule change l'état de l'interrupteur on/off

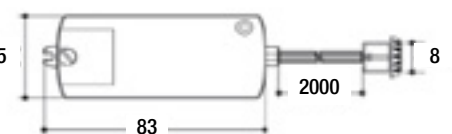

RÉF. ID	PUISSANCE MAX	DÉTECTION	ENTRÉE	SORTIE	PRIX HTVA
ID/00817739	250W	DÉTECTION ± 7CM	230V	230V	€ 27,00



SOURCES

Une source lumineuse, aujourd'hui, ne fournit plus seulement un éclairage fonctionnel ou d'ambiance mais procure également un look plus spécifique au luminaire dans lequel elle s'insère. Ainsi, il en existe de différents types, en formes de globe, de poire, de tube... avec des finitions de verre clair, mat, fumé, ambré... bref, une large collection décorative qui vient s'ajouter à la gamme des sources lumineuses classiques.



SOURCES



E27 DÉCO



1 - ID/02118078



2 - ID/02612145



3 - ID/02612144



4 - ID/02695431



5 - ID/02612146



6 - ID/03274837



7 - ID/03274836



8 - ID/02085440



9 - ID/02773269



10 - ID/02773268



11 - ID/03274847



12 - ID/03274848



13 - ID/03274849



14 - ID/02612147



15 - ID/03274840



16 - ID/03274841



17 - ID/03274842

E27 DÉCO

	RÉF. ID	PUISSANCE	FLUX	T°	COULEUR	DIMENSIONS MM	DIMMABLE	CLASSE ÉNERGÉTIQUE	PRIX HTVA
1	ID/02118078	5W	550 LM	2700°K	○ TRANSPARENT	Ø 95 X 125	OUI	A++	€ 12,40
2	ID/02612145	5W	260 LM	2200°K	● AMBRE	Ø 125 X 175	OUI	A+	€ 14,80
3	ID/02612144	5W	260 LM	2200°K	● AMBRE	Ø 95 X 138	OUI	A	€ 11,50
4	ID/02695431	5W	260 LM	2200°K	● AMBRE	Ø 60 X 60	OUI	A	€ 11,50
5	ID/02612146	5W	260 LM	2200°K	● AMBRE	Ø 64 X 64	OUI	A	€ 11,50
6	ID/03274837	5W	180 LM	2200°K	● FUME	Ø 125 X 175	OUI	A	€ 16,50
7	ID/03274836	5W	180 LM	2200°K	● FUME	Ø 95 X 138	OUI	A	€ 14,00
8	ID/02085440	5W	550 LM	2700°K	○ TRANSPARENT	Ø 64 X 146	OUI	A+	€ 10,70
9	ID/02773269	6W	550 LM	2200°K	● AMBRE	Ø 95 X 165	NON	A	€ 13,20
10	ID/02773268	6W	550 LM	2200°K	● AMBRE	Ø 95 X 135	NON	A	€ 13,20
11	ID/03274847	5W	160 LM	2200°K	● FUME	Ø 32 X 200	OUI	B	€ 19,80
12	ID/03274848	5W	160 LM	2200°K	● FUME	Ø 32 X 250	OUI	A	€ 24,00
13	ID/03274849	5W	160 LM	2200°K	● FUME	Ø 32 X 300	OUI	A	€ 24,00
14	ID/02612147	5W	260 LM	2200°K	● AMBRE	Ø 30 X 140	OUI	A+	€ 16,50
15	ID/03274840	5W	260 LM	2200°K	● AMBRE	Ø 320 X 200	OUI	A	€ 19,00
16	ID/03274841	5W	260 LM	2200°K	● AMBRE	Ø 32 X 250	OUI	A	€ 19,80
17	ID/03274842	5W	260 LM	2200°K	● AMBRE	Ø 32 X 300	OUI	A	€ 21,00



E27



RÉF. ID	PUISSANCE	FLUX	T°	COULEUR	DIMENSIONS MM	PRIX HTVA
ID/03469047	7W	806 LM	2700°K	○ OPALIN	Ø 60 X 105	€ 6,00

E14



RÉF. ID	PUISSANCE	FORME	FLUX	T°	COULEUR	DIMENSIONS MM	PRIX HTVA
ID/03469113	5W	FLAMME	470 LM	2700°K	○ OPALIN	Ø 35 X 102	€ 5,50
ID/03469159	5W	BOULE	470 LM	2700°K	○ OPALIN	Ø 45 X 78	€ 6,00

AR111 DIM TO WARM

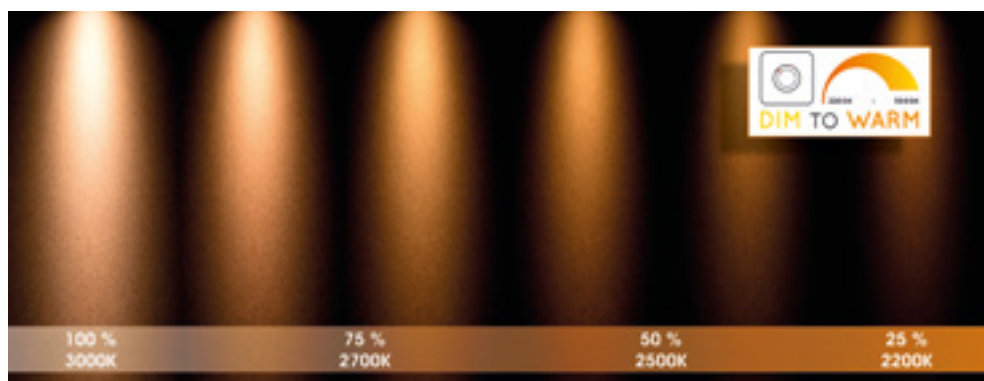

RÉF. ID	PUISSANCE	FLUX	T°	ANGLE	COULEUR	DIMENSIONS MM	PRIX HTVA
ID/03274846	10W	500 LM	2200 - 3000°K	24°	● CHROME	Ø 111 X 57	€ 35,00



GU10



RÉF. ID	PUISSANCE	FLUX	T°	ANGLE	COULEUR	PRIX HTVA
ID/02118070	5W	320 LM	3000°K	40 °	○ BLANC	€ 5,70
ID/02118071	5W	320 LM	3000°K	40 °	● GRIS	€ 5,70
ID/02118069	5W	320 LM	3000°K	40 °	● NOIR	€ 5,70

GU10 DIM TO WARM

**Le conseil de l'éclairagiste:**

Une source Dim-to-Warm, couplée à un variateur, permet de créer des ambiances tamisées avec une couleur de lumière progressivement plus chaude alors que les sources dimmables traditionnelles permettent d'adapter le flux lumineux mais sans modifier la couleur de lumière.

RÉF. ID	PUISSANCE	FLUX	T°	ANGLE	COULEUR	PRIX HTVA
ID/03274833	5W	320 LM	2200 - 3000°K	40 °	○ BLANC	€ 9,00
ID/03274834	5W	320 LM	2200 - 3000°K	40 °	● GRIS	€ 9,00
ID/03274832	5W	320 LM	2200 - 3000°K	40 °	● NOIR	€ 9,00



UTILITAIRES

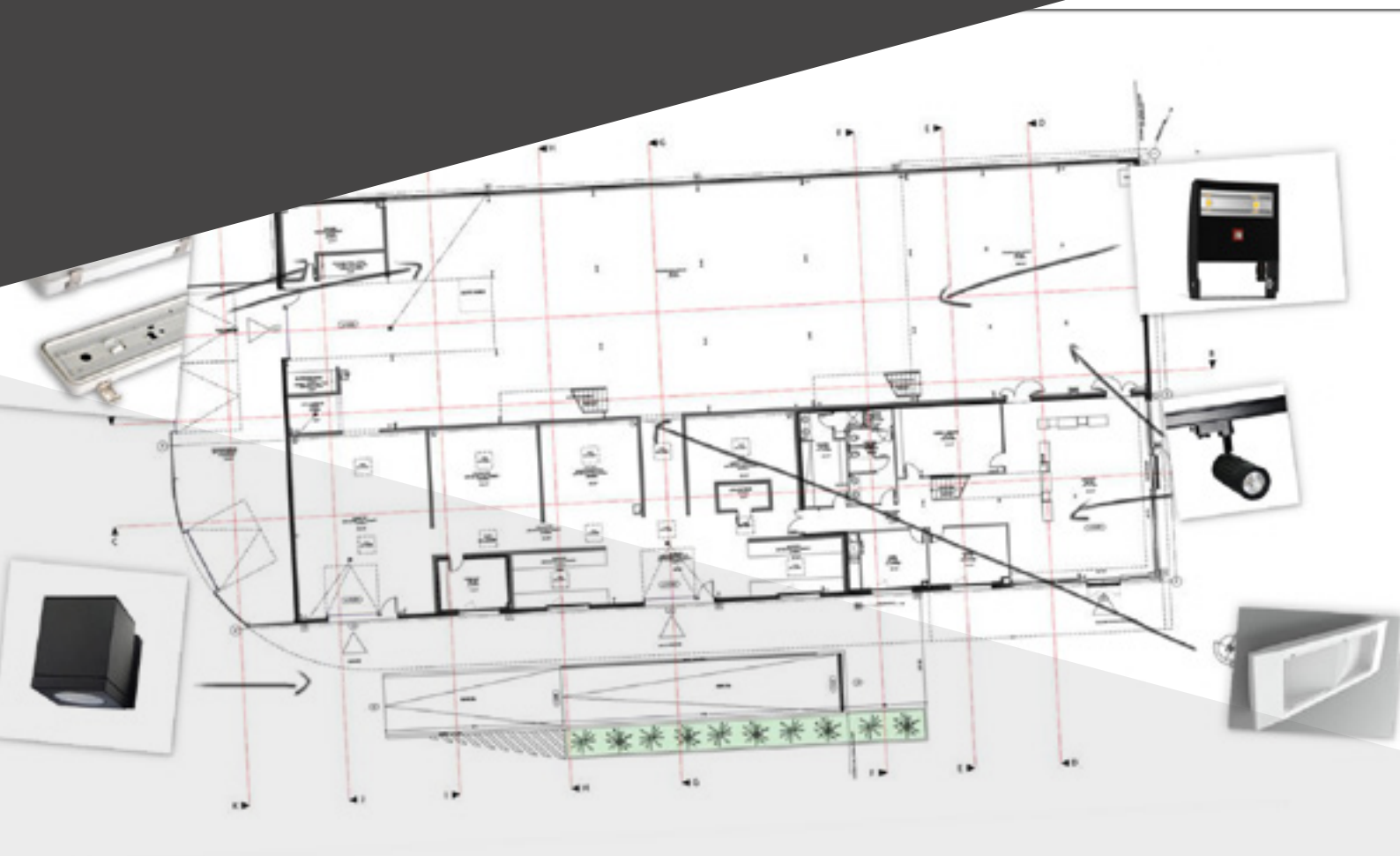

CORRESPONDANCES DES VALEURS UGR

UGR	Activité
28	Zone de circulation, quais...
25	Salle d'archives, escaliers, ascenseur...
22	Espace d'accueil, industrie, artisanat...
19	Activités de bureau, écoles...
16	Dessins techniques, postes de travail CAD...

NIVEAU D'ÉCLAIREMENT MOYEN CONSEILLÉ ESPACES PRIVÉS

Pièce	intensité lumineuse générale	intensité lumineuse locale	Couleur de lumière
Salon et salle à manger	200 lux	De 50 lux pour une ambiance tamisée à 300 lux pour lire	
Cuisine	300 lux	450 lux sur le plan de travail	
Salle de bains	300 lux	500 lux devant le miroir	
Chambre d'adulte	100 lux	250 lux devant le dressing	
Chambre d'enfant	300 lux	500 lux sur les surfaces de jeu et d'étude	
Bureau	250 lux	500 lux sur la surface de travail	
Espace de circulation	100- 200 lux	jusqu'à 300 lux sur le palier	
Garage et buanderie	100- 200 lux	400 lux sur la surface de travail	

NIVEAU D'ÉCLAIREMENT MOYEN CONSEILLÉ ESPACES PROFESSIONNELS

Prescriptions relatives à l'éclairage des locaux	Lux
Magasins et entrepôts	100
Magasins de vente, zone de vente	300
Zones de manutention	300
Bâtiments scolaires, salle de classe	300
Halls de sport, gymnases, piscines	300
Assemblage de précisions, usinages	500
Bibliothèques - salles de lecture	500
Bureaux - réception, classement	300
Bureaux - dactylographie, ordinateur	500
Bureaux - dessins industriels	750

LES INDICES DE PROTECTIONS

Les degrés de protection IP (Indice de Protection) procurés par les enveloppes autour des parties électriques des luminaires sont définis par la norme EN 60-529 IP (Indice de protection). Cet indice de protection se décompose en 2 chiffres après le symbole IP.

Le **premier** indique la protection du luminaire contre les **solides**.

Le **deuxième** indique la protection du luminaire contre les **liquides**.

TABLEAU EXPLICATIF DU PREMIER CHIFFRE DE L'INDICE DE PROTECTION
(DEGRÉ DE PROTECTION CONTRE LA PÉNÉTRATION DES CORPS SOLIDES)

Indice	Schéma	Explication
IP 0 .		La partie électrique du luminaire n'a pas de protection particulière
IP 1 .		La partie électrique du luminaire est protégée contre les corps solides supérieurs à 50 mm (exemple : contact involontaire de la main)
IP 2 .		La partie électrique du luminaire est protégée contre les corps solides supérieurs à 12 mm (doigt de la main)
IP 3 .		La partie électrique du luminaire est protégée contre les corps solides supérieurs à 2,5 mm (outils, fils)
IP 4 .		La partie électrique du luminaire est protégée contre les corps solides supérieurs à 1 mm (outils fin, petit fils)
IP 5 .		La partie électrique du luminaire est protégée contre les poussières (pas de dépôts nuisibles)
IP 6 .		La partie électrique du luminaire est totalement protégée contre les poussières

PROTECTION CONTRE LES CHOCS MÉCANIQUES : INDICE DE PROTECTION IK (DEGRÉ DE PROTECTION CONTRE LES CHOCS MÉCANIQUES EXTERNES.)



IK	TEST	IK	TEST
1	150gr - 100 mm (0,15 joule)	6	500gr - 200mm (1,00 joules)
2	150gr - 133mm (0,20 joule)	7	500gr - 400mm (2,00 joules)
3	150gr - 233mm (0,35 joule)	8	1700gr - 300mm (5,00 joules)
4	250gr - 333mm (0,50 joule)	9	5000gr - 200mm (10,00 joules)
5	150gr - 485mm (0,70 joule)	10	5000gr - 400mm (20,00 joules)

TABLEAU EXPLICATIF DU DEUXIÈME CHIFFRE DE L'INDICE DE PROTECTION (DEGRÉ DE PROTECTION CONTRE LA PÉNÉTRATION DES CORPS LIQUIDES)

Indice	Schéma	Explication
IP . 0		La partie électrique du luminaire n'a pas de protection particulière
IP . 1		La partie électrique du luminaire est protégée contre les chutes verticales de gouttes d'eau (condensation)
IP . 2		La partie électrique du luminaire est protégée contre les chutes d'eau jusqu'à 15° de la verticale
IP . 3		La partie électrique du luminaire est protégée contre l'eau en pluie jusqu'à 60° de la verticale
IP . 4		La partie électrique du luminaire est protégée contre les projections d'eau venant de toutes les directions
IP . 5		La partie électrique du luminaire est protégée contre les projections d'eau venant de toutes les directions à la lance
IP . 6		La partie électrique du luminaire est protégée contre les projections d'eau assimilables aux paquets de mer
IP . 7		La partie électrique du luminaire est protégée contre les effets de l'immersion
IP . 8		La partie électrique du luminaire est protégée contre les effets prolongés de l'immersion sous pression

RÈGLES D'ISOLATION DES LUMINAIRES DANS UNE SALLE DE BAIN

La salle de bain est composée de quatre volumes décrits dans le tableau ci-dessous.

Dans chacun de ces volumes vous devez, afin de respecter la norme, utiliser un luminaire ayant un indice de protection et une classe d'isolation adaptés.

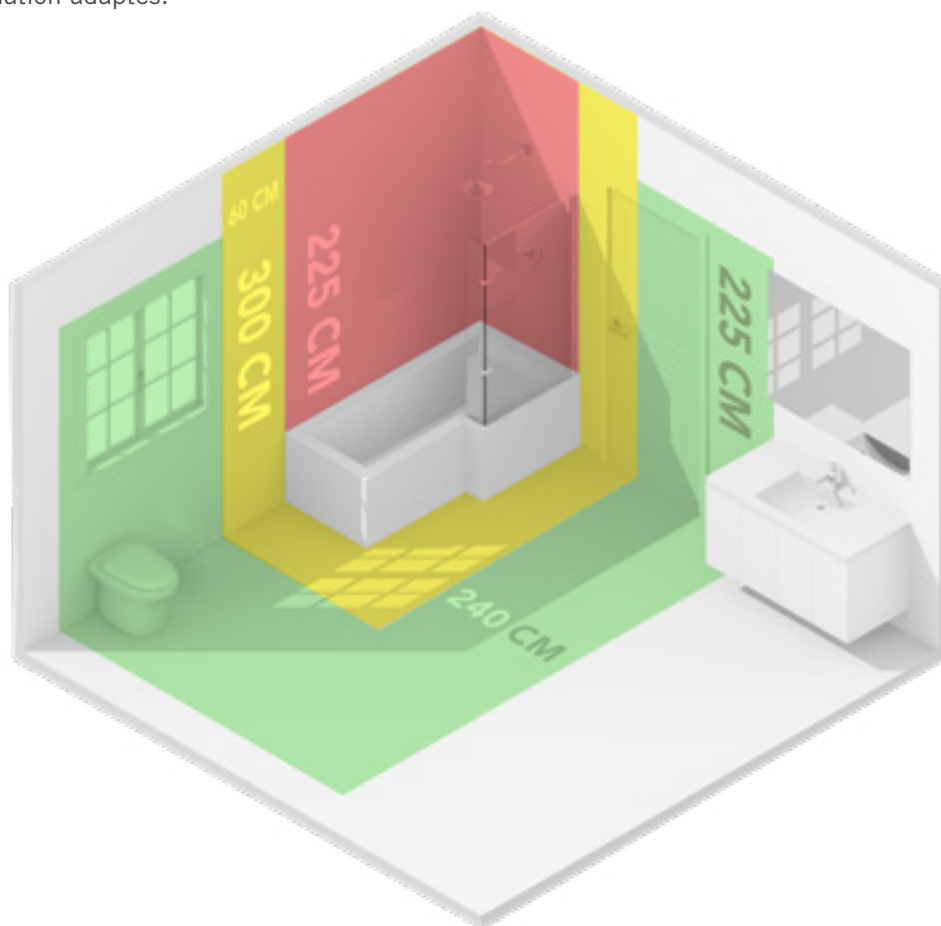

Volume	Définition	IP minimum	Classe requise
Volume 1	Volume au dessus de la baignoire ou du bac à douche jusqu'à 2,25 m de hauteur	IP x 4	3
Volume 2	Volume situé jusqu'à 60 cm du volume 0 et 1 et en dessous de 3 mètres du sol	IP x 4	2 ou 3
Volume 3	Volume situé au delà du volume 2 jusqu'à 2,40 m en horizontal et en dessous de 2,25 mètres du sol	IP x 1	1,2 ou 3
Hors volume	Volume au delà des volumes 0, 1, 2 et 3	IP x 00	1,2 ou 3

INDEX PAR NOMS

350mA NON DIMMABLE	446	BERGAMO	237	DC 24V NON DIMMABLE	444
500mA NON DIMMABLE	447	BERN	282	DEBI RD	52
700mA NON DIMMABLE	448	BETHAN	222	DEBI RD-230	52
2216 - IP20	8	BIARRITZ	315	DELTA	174
2216 - IP66	9	BIDI	338	DÉTECTEUR 360	307
2835 - IP20	10	BIDI APPLIQUE	368	DÉTECTEURS 200	306
2835 IP65-67	11	BIG APA RD-230	325	DÉTECTEURS 240	306
ABY 1 RD	58	BOA	180	DIDO	20
ABY 2 RD	58	BODI	124	DINGO	381
ABY 3 RD	59	BODI ROND	124	DINGO B	334
ACCESSOIRES POUR RAILS	248	BODO	169	DISK	426
ACCESSOIRES POUR RAILS	256	BOLAS	327	DOMAS	20
ACCESSOIRES POUR RAILS 48V	272	BOMBAY	322	DOME	395
ACCESSOIRES POUR RAILS 48V	274	BOO 1	289	DUBLIN	107
ACRO+	431	BOO 1 T	280	DUCA	66
ACRO+ DÉTECTEUR	431	BOO 2	289	DUCA P	67
ACRO+ SECOURS	431	BORNE TEXAS + DÉTECTEUR	300	DUCA P TRIMLESS	67
AESTETICA LED	420	BOUNDE	169	DUCA TRIMLESS	66
AL1014 R	54	BOX 1.0	130	DUDLEY DOWN	380
AL1014 RDX	54	BOX 2.0	131	DUDLEY OVAL	380
AL1014 RDX OUT	405	BOXER	200	DUDLEY ROUND	381
ALIEN MINI	103	BOX MINI 2.0	218	DUKAN	377
ALIEN MINI DET	293	BOXY +	398	DUKAN	401
ALIS 1014 R	55	BRICK	375	E14	460
AMUR	221	BRICK PRO	422	E27	460
ANDRIA	104	BRISTOL	313	E27 DÉCO	459
ANKARA	72	CADIX	285	EASY	86
ANTIBES	313	CADRA	383	ECHO	358
APRIL	385	CALLISTO	400	ECHO	398
AR111 DIM TO WARM	460	CALLISTO WALL	394	ECHO DOUBLE	359
ARAGO	23	CASAR	303	EKLYPS LED	208
ARCHI BICOLOR	12	CERES CARRÉ	109	ELIOS	98
ARCHI RGB	12	CERES ROND	108	ELIR	39
ARRAS	323	CHAMONIX	197	ENIMA	115
ARROW	330	CHAMPION	238	ENIMA SUSPENSION	182
ARTELINE	270	CHIBA	112	ENOLA-B	251
ARTHUR	120	CLAC 1 MINI	140	ENOLA SUSPENSION	253
ARTHUR	165	CLAC 2 MINI	140	ENROULED	440
ARTHUR	206	CLAIRE	374	E PRO FLOOD SENSOR	304
ARTHUR	230	CLAIRE	340	E PRO FLOOD SENSOR	414
ARTHUR FLOOR	230	CLAIRETTE A	303	E PRO SPOT SENSOR	304
ASPI 1 SENSOR	296	CLX+	103	E PRO SPOT SENSOR	415
ASPI 1 SENSOR PLUS	297	CLX+ HF	294	ETTA	170
ASPI 2 SENSOR	296	CLX+ SEC + DET	425	EURO	252
ASPI 2 SENSOR PLUS	297	COB 528	6	EURO	421
ATKIN	201	COLOGNE	390	EVA	222
ATLANTE II	432	COLOGNE MINI	394	EVOLED	50
ATLANTIS II	320	COMBO	330	EXITA SWING	423
AURA 3	114	CONA FLOOR	234	EXOLED	51
AURA 4	114	CONA TABLE	234	FIJI LED	433
AVI	333	CONTRÔLEUR 4 EN 1	454	FILI 1 RX GU10	49
AVO	250	CONTRÔLEUR MURAL ZIGBEE	35	FIX WALL	203
AVORIAZ	358	CONTRÔLEUR MURAL ZIGBEE	35	FLASH	269
AVORIAZ DOUBLE	358	COPE RD	59	FLIP	439
BALI	321	COSMOS	361	FLOM	410
BALI CARRÉ	314	COSMOS DOUBLE	361	FLOM SENSOR	411
BAMBURGH	102	COURCHEVEL	92	FOCEA	91
BAMBURGH DET	292	CROBAT	199	FOGGIA	105
BAMBURGH SEC	424	CUBE DOUBLE LUX	134	FONDA	312
BAMBURGH SEC + DET	424	CUBE LUX	134	FOOD - RUBAN ALIMENTAIRE	14
BANKER	242	CURIE	384	FRAME MINI	391
BASE LINEAIRE	177	CUSCO	215	FRAME ROUND	392
BASE RONDE	176	DAN	21	FRAME ROUND DET	298
BELFAST	366	DARF 1	187	FRAME ROUND MAXI	403
BENS P	336	DARF 1	212	FRAME ROUND MAXI DET	299
BENTOO	125	DASAR FLAT 80	323	FRAME ROUND WALL	393

INDEX PAR NOMS

FRAME SQUARE	392	KAMINO	326	MANU	245
FRAME SQUARE DET.	298	KARO 1	281	MANUELA	168
FRAME SQUARE MAXI	403	KARO 2	281	MANUELA	120
FRAME SQUARE MAXI DET	299	KARO 3	281	MANYL 1	138
FRAME SQUARE WALL	393	KARTY	80	MANYL 2	138
FULLA	215	KAVA	214	MANYL 2 GU10	138
GALEN	198	KNULLE	233	MARGARY	158
GARI	64	KOBI	346	MEDI	427
GARI P.	65	KORBA	106	METRO	360
GARI P TRIMLESS	65	KUANA	132	METRO	398
GARI TRIMLESS	64	KUANA S	74	METRO DOUBLE	360
GEOLED	388	KUPA	214	MIKA FLOOR	240
GEOLED	389	LAK	314	MIKA TABLE	240
GIANA	24	LA PAZ 20	111	MILDBEAM FLAT HIGH BAY	435
GIANA L	24	LA PAZ 40	111	MILO	198
GLAM	209	LA ROCHELLE	126	MILO 2	198
GOA	336	LARY RD & LARY SD	62	MIMIK	337
GOA	109	LAZER	16	MINI CLIC	80
GOA	366	LAZER DEMI ROND	17	MINI DÉTECTEUR 360 ENCASTRÉ	307
GOLDO II	434	LAZER RGB	17	MINI DÉTECTEUR ET INTERRUPTEUR RUBANS LED	30
GREG	139	LAZER THIN	16	MINIMAL	352
GU10	461	LEANNE	163	MIRBA 1	224
GU10 DIM TO WARM	461	LEDLINER 35	119	MIRBA 2	225
GUELL ZERO	417	LEDLINER 35	191	MIRBA 3	225
GUN LED 28W	260	LEGA	286	MIRO	223
GUN LED 42W	261	LENA	68	MIZUKO	199
GURI	182	LENA P	69	MODULE POUR CONTRÔLE LUMINAIRES DC24V (RUBANS LED, ...)	453
GYRO	324	LENA P TRIMLESS	69	MODULE POUR CONTRÔLE LUMINAIRES LED 0-10V OU DALI	452
GYRO ASYMETRIQUE	324	LENA TRIMLESS	68	MODULE POUR CONTRÔLE LUMINAIRES LED DIM. TRIAC (220V)	452
HALO	258	LEO	20	MONTE CARLO	321
HD1014 R	55	LESTER	162	MOON	244
HEDI	216	LEVANTO	349	MOON 500	110
HELIA	251	LEVANTO	417	MOON DET.	294
HESTER FLOOR	235	LIANA	19	MOON SEC + DET	425
HESTER TABLE	235	LIBRA	402	MYRA	207
HIDE	84	LIGHT EYE BALL	252	NAULA 40	154
HOCKENHEIM	364	LIGHT EYE BALL SUSPENSION	253	NAULA 60	155
HOLLYWOOD	430	LIKA	312	NAULA BASE CARRÉE	149
HYDROLED	322	LIMA 25W	264	NAULA BASE LINÉAIRE ASYMÉTRIQUE	150
HYDROLED ASYMÉTRIQUE	322	LIMA 35W	265	NAULA BASE LINÉAIRE SYMÉTRIQUE	150
IENA RDX	53	LIMA 50W	266	NAULA BASE RONDE	149
IENA RDX-230	53	LINEA 1	271	NAULA SPOT 40	148
INDIVILED	192	LINEA 2	271	NAULA SPOT 60	148
INNOVLED	44	LISY RD	70	NAUTILUS	346
INNOVLED TRIAC	45	LISY RDX	70	NERES	377
INTERRUPTEUR CAPTEUR DE PROXIMITÉ ON - OFF	455	LONGA	217	NEW FLASH	388
INTRO MAXI	351	LOPAL	200	NEW LOOP III	408
INTRO MIDI	350	LOPAL NEW	147	NEW LOOP III PIR	409
INTRO MINI	350	LORENZ	158	NEWTA	47
IRO 1	287	LORIN FLOOR	228	NIGEL	141
IRO 2	287	LORIN TABLE	228	NINKE P.	330
ITO	395	LOS ANGELES 7	86	NINKE WALL	378
IXOLED	51	LOS ANGELES 14	87	NOBLO	251
IZAK	186	LOS ANGELES 25	87	NOIA	156
JASTER LED	144	LUPO 1	133	NORD	303
JEDI	223	LUPO 1 GU10	133	NORDIC	232
JIMY 2	258	LUPO 2	133	NORMA +	432
JOE	242	LUXI 45 SENSOR	304	NUALA	365
JULIUS	171	LUXI 175 SENSOR	305	NYSIT	146
JUNCUS	353	LUXI 175 SENSOR P.	305	ODREY 1	160
JUNISTAR ECO	60	MAGIC POWER GEL	319	ODREY TRACK	254
JUNISTAR ISOSAFE TW	60	MAGNETICA	38	ODREY WALL	210
JUNISTAR LUX ISOSAFE	61	MALTA	212	OMAC	91
JUNISTAR LUX ISOSAFE	404	MALTA 2	213		
KALA	342	MANAL	348		
KALKI	343	MANCHON À GEL	319		

INDEX PAR NOMS

ONEX	282	RGB + CCT	13	SYTZE	185
OREGON	204	RHINO	389	T6 GARDEN	354
ORIS	167	RHO	326	TALA	137
ORKI	110	RICKY	168	TALOWE	113
ORKI	293	RILOU	145	TALOWE	179
ORRIN	172	RIMINI	126	TANNER	164
ORRIN TABLE	232	RINGO	320	TANNER	203
OSIS 1	268	RODA C	118	TANNER L	229
OSIS 2	268	RODA P	188	TANNER O	229
OSLO	110	RODI A	325	TATUM	334
OVALIS	209	RONDO P	333	TATUM	352
OZORA	189	RONDO WALL	378	TELA 10/20/30/40	127
PADO	339	ROTTERDAM	139	TÉLÉCOMMANDE CASAMBI	453
PANAMA 4	88	SAN DIEGO	90	TÉLÉCOMMANDE CONTRÔLEUR BLUETOOTH	32
PANAMA 6	88	SARA SNOOZE	205	TÉLÉCOMMANDE CONTRÔLEUR RGB + CCT	32
PANAMA 8	89	SCOPE	157	TÉLÉCOMMANDE MONO ZIGBEE	34
PANAMA 8 HR	89	SEBO	202	TÉLÉCOMMANDE ZIGBEE	34
PANEL	96	SELIN	159	TENKO	410
PANEL UGR	97	SERENATE	385	TEXAS	337
PARA	342	SET DE CONTRÔLE BLANC CHAUD - BLANC FROID	31	TEXAS	366
PARO 1	276	SET DE CONTRÔLE MONOCHROME	31	TEXAS + DÉTECTEUR	300
PARO 2	277	SET DE CONTRÔLE RGB	31	THESI	383
PARO 3	278	SET DE CONTRÔLE RGBW	31	THIN	217
PHILINE FLOOR	236	SF CIRCULAR	102	THOR	166
PHILINE TABLE	236	SF CIRCULAR SENSOR	292	THOR	121
PIKI	346	SHARK	413	THOR	207
PLANE	426	SHEFFIELD	196	THOR FLOOR	231
PLANE MINI	426	SIGMA	184	THOR TABLE	231
PLATA	23	SINGA	377	TIBLI R-B	71
POCKET	438	SIRA R	90	TIDIAN	320
POLO+ 1	370	SKANSKA FLOOR	239	TIRENO LANTERN P	341
POLO+ 2	371	SKANSKA TABLE	239	TIRENO LANTERN S	341
POLO+ 3	371	SLAT	372	TIRENO WALL	379
POLO+ ZERO	370	SLAT ONE	373	TITAN FIX ROUND	63
POWERPOINT	353	SNAKE	349	TITAN MIX	63
POWER TUBE	440	SOCLE POUR VARIATEUR 1-10V	450	TOKYO	178
PRAVE	21	SOCLE POUR VARIATEUR À BOUTON-POUSOIR	450	TRACKLINE 55	270
PROFIL BLACK EDITION PREMIUM	26	UNIVERSEL	450	TRÉPIED TÉLESCOPIQUE POUR PROJECTEUR LED	441
PROLINE ROW 1	189	SOCLE POUR VARIATEUR À BOUTON ROTATIF UNIVERSEL	450	TRIMLESS	116
PROPER	430	SOLVELA	416	TRIMLESS	190
PURE FLOOR H	241	SPIDER +	412	TRINITY	181
PURE FLOOR M	241	SPIKE	347	TUBULE	159
PURE LINE	183	SPIKE DOUBLE	387	TULO	340
PURI	250	SPIKE DOUBLE + 2 PRISES	387	TULO DET	301
QIJO	108	SPIKE SIMPLE	387	TURNON	145
QUASAR 10	362	SPIRA 1 RX	93	TURNON	204
QUASAR 10	399	SPIRA 3	93	TWIN	427
QUASAR 20	362	SPLIT 1/2/3	142	UP LED	420
QUASAR 30	363	SPOT BASE	48	VALERA	23
RAILS APPARENTS 48V	272	SPOT BASE IP54	48	VAL THORENS	50
RAILS ENCASTRÉS 48V	274	SPOTI R-B	72	VARIATEUR LEDDIM À BOUTON ROTATIF	451
RAILS MONOPHASÉS 230V	248	SPOTI R-B OUT	405	VARIATEUR LEDDIM DALI TW	451
RAILS TRIPHASÉS 230V	256	SPRINGFIELD	312	VARIATEUR LEDDIM SMART TW	451
RAMA	343	STEP	213	VERBIER	414
RAY 1.0	129	STOCKHOLM	107	VERLI	22
RAYA	185	STOCKHOLM	402	VIEW	220
RAY MINI 2.0	219	STRASBOURG	79	VIEW 900	221
RÉCEPTEUR/ALIMENTATION ZIGBEE DC24V	36	STRASBOURG MICRO	77	VIGO	284
RÉCEPTEUR BLUETOOTH 4 EN 1	32	STRASBOURG MINI	78	WALL	384
RECEPTEUR BLUETOOTH 230V	455	SULLY C	118	WALL WASHER	369
RÉCEPTEUR ZIGBEE 12-24V (1 X 8A)	36	SULLY P	188	WATTO	46
RÉCEPTEUR ZIGBEE 12-24V (4 X 5A)	36	SWEET RD A & RD A WARM	57	WIDE	84
RÉCEPTEUR ZIGBEE 230V	454	SWEET RD & RD WARM	56	WIDO	382
REGULED	39	SYLA-B	75	WORK AA	438
REX 2	364	SYNA	348	WORK BATTERY	439
RGB+ BLANC	13			XIRAX	136

INDEX PAR NOMS

XYRUS.....	143
YELI	376
YERA GU10	259
YIKA	382
ZAZOU.....	399
ZEFIX	137
ZENITH	238
ZORA-LED	359
ZORA-LED DOUBLE	359
ZOZY.....	237

INDEX PAR RÉFÉRENCES

ID/00546832	379	ID/01356797	237	ID/01607127	129	ID/01784698	11
ID/00546835	379	ID/01429669	319	ID/01607131	219	ID/01784723	322
ID/00546838	341	ID/01441500	248	ID/01607132	219	ID/01784790	409
ID/00546841	341	ID/01441501	248	ID/01607133	219	ID/01784791	409
ID/00546844	341	ID/01441628	323	ID/01609892	168	ID/01784793	409
ID/00547510	242	ID/01448933	196	ID/01609893	168	ID/01784794	409
ID/00600885	398	ID/01448934	196	ID/01609900	232	ID/01784795	409
ID/00600886	398	ID/01448935	196	ID/01609946	124	ID/01784796	409
ID/00600887	398	ID/01449010	321	ID/01609947	124	ID/01872492	174
ID/00616692	450	ID/01449011	321	ID/01609948	124	ID/01881184	213
ID/00776440	358	ID/01449019	110	ID/01609950	124	ID/01881186	213
ID/00776442	359	ID/01449633	307	ID/01609951	124	ID/01881188	213
ID/00776444	398	ID/01449635	307	ID/01609953	124	ID/01887905	130
ID/00776446	360	ID/01477694	55	ID/01609954	124	ID/01887911	131
ID/00776448	360	ID/01477695	55	ID/01610081	145	ID/01887940	129
ID/00776450	398	ID/01477700	54	ID/01610082	145	ID/01888022	218
ID/00776503	358	ID/01477701	54	ID/01610083	145	ID/01888023	219
ID/00776505	359	ID/01554717	22	ID/01610084	145	ID/01893257	39
ID/00776507	398	ID/01554718	22	ID/01610104	366	ID/01893258	39
ID/00776509	360	ID/01554722	24	ID/01610192	234	ID/01893259	39
ID/00776511	360	ID/01554724	24	ID/01610193	234	ID/01893260	39
ID/00776513	398	ID/01554724	27	ID/01704645	362	ID/01893261	39
ID/00817098	366	ID/01554726	22	ID/01704651	362	ID/01908742	239
ID/00817099	337	ID/01554727	24	ID/01704657	362	ID/01908743	239
ID/00817100	337	ID/01554727	27	ID/01704672	362	ID/01908748	239
ID/00817696	190	ID/01554729	22	ID/01704681	362	ID/01908749	239
ID/00817739	455	ID/01554731	24	ID/01704687	363	ID/01908816	169
ID/00995568	420	ID/01554732	13	ID/01704699	363	ID/01910425	253
ID/01056363	248	ID/01554748	445	ID/01706610	417	ID/01910426	253
ID/01056364	248	ID/01554750	445	ID/01721424	321	ID/01910433	252
ID/01056365	248	ID/01554766	223	ID/01721766	248	ID/01910434	252
ID/01056366	248	ID/01554767	223	ID/01721767	248	ID/01910435	252
ID/01056367	248	ID/01581126	39	ID/01721768	248	ID/01910437	252
ID/01056368	248	ID/01581127	39	ID/01721769	248	ID/01910440	253
ID/01056369	248	ID/01581128	39	ID/01721770	248	ID/01917100	86
ID/01056370	248	ID/01581129	39	ID/01721771	248	ID/01917101	87
ID/01056371	248	ID/01581130	39	ID/01721772	249	ID/01917102	87
ID/01056372	248	ID/01588199	262	ID/01721774	249	ID/02085330	169
ID/01056373	249	ID/01588200	262	ID/01721775	249	ID/02085335	242
ID/01056374	249	ID/01588201	262	ID/01721776	249	ID/02085345	125
ID/01056377	249	ID/01588202	262	ID/01721776	254	ID/02085346	125
ID/01056378	249	ID/01588205	262	ID/01721780	249	ID/02085347	125
ID/01056379	249	ID/01588206	262	ID/01721781	249	ID/02085348	125
ID/01056380	249	ID/01594527	312	ID/01721782	249	ID/02085357	209
ID/01056383	249	ID/01594528	312	ID/01721784	249	ID/02085358	209
ID/01056383	254	ID/01594529	312	ID/01721787	249	ID/02085364	381
ID/01056384	249	ID/01604771	321	ID/01721799	250	ID/02085365	381
ID/01056385	249	ID/01604772	321	ID/01721803	253	ID/02085433	167
ID/01056386	249	ID/01606296	130	ID/01721804	253	ID/02085440	459
ID/01056395	250	ID/01606297	130	ID/01722006	252	ID/02091084	387
ID/01056396	250	ID/01606298	130	ID/01722007	252	ID/02091094	387
ID/01056688	252	ID/01606299	130	ID/01729950	327	ID/02091097	387
ID/01056746	251	ID/01606300	130	ID/01729980	327	ID/02091099	387
ID/01057409	346	ID/01606313	131	ID/01730010	327	ID/02091116	387
ID/01057410	346	ID/01606314	131	ID/01732568	330	ID/02091119	387
ID/01089551	214	ID/01606315	131	ID/01732569	330	ID/02091121	387
ID/01194538	12	ID/01606316	131	ID/01732570	330	ID/02092747	339
ID/01194539	12	ID/01606317	131	ID/01732571	300	ID/02092751	339
ID/01194541	12	ID/01606319	131	ID/01732572	300	ID/02108579	389
ID/01194542	12	ID/01606321	131	ID/01732587	326	ID/02108580	389
ID/01220925	326	ID/01606322	131	ID/01735417	326	ID/02108581	389
ID/01252482	252	ID/01606326	218	ID/01735943	326	ID/02108582	389
ID/01252494	249	ID/01606327	218	ID/01736043	30	ID/02108583	389
ID/01252495	249	ID/01606328	218	ID/01736067	72	ID/02108584	389
ID/01253229	54	ID/01607119	129	ID/01736068	72	ID/02108585	389
ID/01253230	54	ID/01607120	129	ID/01736089	107	ID/02108586	389
ID/01266723	364	ID/01607121	129	ID/01736090	107	ID/02108587	388
ID/01286618	55	ID/01607122	129	ID/01736091	107	ID/02108588	388
ID/01286619	55	ID/01607123	129	ID/01784695	11	ID/02108589	388
ID/01317212	237	ID/01607124	129	ID/01784696	11	ID/02108590	388
ID/01317213	237	ID/01607126	129	ID/01784697	11	ID/02108591	388

INDEX PAR RÉFÉRENCES

ID/02108592	388	ID/02199976	256	ID/02233007	8	ID/02289094	86
ID/02108593	388	ID/02199977	256	ID/02233008	8	ID/02289136	306
ID/02108594	388	ID/02199981	257	ID/02233018	260	ID/02289137	306
ID/02108668	110	ID/02199982	257	ID/02233019	260	ID/02289138	306
ID/02116033	420	ID/02199984	257	ID/02233020	260	ID/02289154	307
ID/02116091	262	ID/02199985	257	ID/02233021	260	ID/02289159	307
ID/02116092	262	ID/02199987	257	ID/02257521	337	ID/02289180	306
ID/02116093	262	ID/02199988	257	ID/02257522	337	ID/02289181	306
ID/02116094	262	ID/02199990	257	ID/02257523	337	ID/02289182	306
ID/02116095	262	ID/02199991	257	ID/02257524	337	ID/02323007	384
ID/02116096	262	ID/02199999	256	ID/02257528	352	ID/02323008	384
ID/02118029	359	ID/02200000	256	ID/02257529	430	ID/02323009	384
ID/02118030	359	ID/02204597	79	ID/02257530	430	ID/02323010	384
ID/02118031	359	ID/02204598	79	ID/02257535	86	ID/02323046	361
ID/02118032	359	ID/02204599	79	ID/02257536	86	ID/02323047	361
ID/02118069	461	ID/02204600	79	ID/02257537	86	ID/02323048	361
ID/02118070	461	ID/02204601	79	ID/02257538	86	ID/02323049	361
ID/02118071	461	ID/02204602	79	ID/02257551	84	ID/02323050	361
ID/02118078	459	ID/02204603	79	ID/02257552	389	ID/02323051	361
ID/02122136	111	ID/02204604	79	ID/02257553	389	ID/02323052	361
ID/02122137	111	ID/02204635	21	ID/02257631	330	ID/02323053	361
ID/02122138	111	ID/02204636	20	ID/02262242	116	ID/02323054	361
ID/02122139	111	ID/02204637	21	ID/02262243	116	ID/02323055	361
ID/02122178	312	ID/02204638	20	ID/02262244	116	ID/02323056	361
ID/02122179	312	ID/02204678	30	ID/02262248	116	ID/02323057	361
ID/02122186	86	ID/02204688	322	ID/02262249	116	ID/02324197	400
ID/02122187	87	ID/02204689	322	ID/02262250	116	ID/02324198	394
ID/02122188	87	ID/02204691	321	ID/02262254	116	ID/02324227	400
ID/02122196	31	ID/02204692	321	ID/02262254	190	ID/02324228	394
ID/02122197	31	ID/02204695	72	ID/02262255	116	ID/02324245	400
ID/02122198	31	ID/02204696	72	ID/02262255	190	ID/02324246	394
ID/02122199	31	ID/02204708	87	ID/02262256	116	ID/02325432	238
ID/02122919	322	ID/02204709	87	ID/02262256	190	ID/02325433	238
ID/02122921	322	ID/02223533	75	ID/02262260	116	ID/02325459	383
ID/02138699	321	ID/02223534	75	ID/02262260	190	ID/02325461	383
ID/02138700	321	ID/02223535	75	ID/02262261	116	ID/02325462	347
ID/02151897	326	ID/02223545	55	ID/02262261	190	ID/02325463	374
ID/02151900	326	ID/02223546	55	ID/02262262	116	ID/02325533	139
ID/02179832	372	ID/02223547	55	ID/02262262	190	ID/02325534	139
ID/02179833	372	ID/02223548	55	ID/02262266	116	ID/02325580	113
ID/02199765	8	ID/02223571	72	ID/02262266	190	ID/02325581	208
ID/02199766	8	ID/02223572	72	ID/02262267	116	ID/02325582	208
ID/02199767	8	ID/02223573	72	ID/02262267	190	ID/02325583	179
ID/02199768	8	ID/02223574	72	ID/02262268	116	ID/02325625	168
ID/02199769	8	ID/02223722	212	ID/02262268	190	ID/02325626	168
ID/02199770	8	ID/02227548	144	ID/02262272	116	ID/02374902	450
ID/02199771	8	ID/02227549	144	ID/02262272	190	ID/02374941	372
ID/02199772	8	ID/02227550	144	ID/02262273	116	ID/02374942	372
ID/02199773	8	ID/02227551	144	ID/02262273	190	ID/02444092	96
ID/02199774	8	ID/02227552	144	ID/02262274	116	ID/02444093	96
ID/02199775	445	ID/02227553	144	ID/02262274	190	ID/02484238	106
ID/02199896	256	ID/02227554	144	ID/02262278	116	ID/02484239	106
ID/02199897	256	ID/02227555	144	ID/02262278	190	ID/02484242	106
ID/02199899	256	ID/02227749	167	ID/02262279	116	ID/02484243	106
ID/02199900	256	ID/02227888	168	ID/02262279	190	ID/02484247	106
ID/02199902	256	ID/02227889	168	ID/02262280	116	ID/02484248	106
ID/02199903	256	ID/02229567	160	ID/02262280	190	ID/02484250	314
ID/02199925	256	ID/02229568	160	ID/02262284	116	ID/02484252	314
ID/02199926	256	ID/02232978	368	ID/02262284	190	ID/02484254	314
ID/02199933	257	ID/02232979	368	ID/02262285	116	ID/02484256	314
ID/02199934	257	ID/02232982	338	ID/02262285	190	ID/02484258	314
ID/02199935	257	ID/02232983	338	ID/02262286	116	ID/02499741	370
ID/02199936	257	ID/02232984	338	ID/02262286	190	ID/02499743	370
ID/02199937	257	ID/02232985	338	ID/02271518	250	ID/02499745	370
ID/02199938	257	ID/02232986	338	ID/02271519	250	ID/02499746	370
ID/02199939	257	ID/02232986	368	ID/02271520	250	ID/02499747	371
ID/02199941	257	ID/02232987	368	ID/02271938	348	ID/02499748	371
ID/02199970	256	ID/02232988	338	ID/02271939	348	ID/02499749	371
ID/02199971	256	ID/02232988	368	ID/02271940	348	ID/02499750	371
ID/02199973	256	ID/02232989	368	ID/02271941	348	ID/02499753	371
ID/02199974	256	ID/02232990	368	ID/02289093	86	ID/02499754	371

INDEX PAR RÉFÉRENCES

ID/02499755	371	ID/02517953	90	ID/02609969	150	ID/02612163	166
ID/02499756	371	ID/02517964	105	ID/02609970	150	ID/02612165	231
ID/02499757	370	ID/02517965	105	ID/02609971	149	ID/02612167	231
ID/02499758	370	ID/02517966	105	ID/02609972	150	ID/02612176	201
ID/02499760	370	ID/02517967	105	ID/02609973	150	ID/02612177	201
ID/02499761	370	ID/02517968	105	ID/02609974	148	ID/02612579	199
ID/02504685	260	ID/02517969	105	ID/02609974	154	ID/02612580	199
ID/02504686	260	ID/02517972	104	ID/02609975	148	ID/02612654	430
ID/02504687	270	ID/02517973	104	ID/02609975	154	ID/02612670	385
ID/02504688	270	ID/02517974	104	ID/02609976	148	ID/02612686	384
ID/02504689	270	ID/02517975	104	ID/02609976	154	ID/02612687	384
ID/02504690	270	ID/02517976	104	ID/02609978	148	ID/02612713	364
ID/02508957	399	ID/02517977	104	ID/02609979	148	ID/02612714	364
ID/02508958	399	ID/02539712	270	ID/02609980	154	ID/02612718	320
ID/02508959	399	ID/02539713	270	ID/02609981	154	ID/02612719	320
ID/02508960	399	ID/02539714	270	ID/02609982	154	ID/02614445	384
ID/02508961	399	ID/02539715	270	ID/02609983	154	ID/02614446	384
ID/02508962	399	ID/02539719	198	ID/02609984	148	ID/02614464	353
ID/02509553	224	ID/02539720	198	ID/02609985	148	ID/02628627	358
ID/02509554	224	ID/02539723	374	ID/02609986	154	ID/02628628	358
ID/02509555	225	ID/02539724	374	ID/02609987	154	ID/02628629	358
ID/02509556	225	ID/02539725	222	ID/02609988	154	ID/02628630	358
ID/02509557	225	ID/02539726	222	ID/02609989	154	ID/02628633	92
ID/02509558	225	ID/02551181	251	ID/02609990	149	ID/02628634	92
ID/02509813	235	ID/02551182	251	ID/02609991	149	ID/02628635	92
ID/02509814	235	ID/02554224	22	ID/02609992	149	ID/02628636	92
ID/02509815	235	ID/02554225	21	ID/02609992	155	ID/02628637	92
ID/02509816	235	ID/02554227	23	ID/02609994	149	ID/02628638	92
ID/02509817	199	ID/02554229	21	ID/02609994	155	ID/02628639	92
ID/02509835	374	ID/02554230	21	ID/02609996	149	ID/02628640	92
ID/02509836	340	ID/02554231	20	ID/02609996	155	ID/02628641	92
ID/02509837	340	ID/02554244	11	ID/02609999	148	ID/02628642	92
ID/02509852	185	ID/02554245	11	ID/02610000	148	ID/02628646	414
ID/02509853	185	ID/02554250	444	ID/02610001	155	ID/02628647	414
ID/02510136	198	ID/02554252	444	ID/02610002	155	ID/02628649	77
ID/02510137	198	ID/02554253	444	ID/02610003	155	ID/02628650	77
ID/02510138	198	ID/02554254	444	ID/02610004	155	ID/02628651	77
ID/02510160	223	ID/02554255	444	ID/02610005	148	ID/02628652	77
ID/02510161	114	ID/02554256	444	ID/02610006	148	ID/02628653	77
ID/02510162	114	ID/02554260	98	ID/02610007	155	ID/02628654	77
ID/02510163	114	ID/02554266	98	ID/02610008	155	ID/02628655	77
ID/02510164	114	ID/02558616	115	ID/02610009	155	ID/02628656	77
ID/02510172	269	ID/02558616	182	ID/02610010	155	ID/02628676	391
ID/02510173	269	ID/02558617	115	ID/02610030	106	ID/02628677	391
ID/02510174	269	ID/02558617	182	ID/02610031	106	ID/02628678	391
ID/02510175	269	ID/02558618	182	ID/02610036	106	ID/02628682	392
ID/02510186	258	ID/02578889	110	ID/02610037	106	ID/02628684	392
ID/02510187	258	ID/02578890	294	ID/02610042	106	ID/02628686	298
ID/02510188	258	ID/02578891	294	ID/02610043	106	ID/02628687	392
ID/02510225	72	ID/02580734	450	ID/02611979	202	ID/02628689	298
ID/02510226	72	ID/02602372	98	ID/02611980	202	ID/02628690	392
ID/02517909	447	ID/02604376	203	ID/02611981	203	ID/02628691	403
ID/02517910	139	ID/02609935	433	ID/02611983	165	ID/02628693	299
ID/02517911	78	ID/02609937	433	ID/02611984	165	ID/02628695	403
ID/02517912	78	ID/02609942	433	ID/02611986	230	ID/02628696	403
ID/02517913	78	ID/02609946	433	ID/02612006	334	ID/02628698	299
ID/02517914	78	ID/02609954	149	ID/02612007	334	ID/02628700	403
ID/02517915	78	ID/02609955	150	ID/02612013	378	ID/02628701	403
ID/02517916	78	ID/02609956	149	ID/02612014	330	ID/02628703	299
ID/02517917	78	ID/02609957	150	ID/02612016	377	ID/02628705	403
ID/02517918	78	ID/02609958	215	ID/02612018	238	ID/02628706	392
ID/02517928	394	ID/02609959	215	ID/02612019	238	ID/02628707	298
ID/02517929	390	ID/02609960	215	ID/02612097	170	ID/02628708	392
ID/02517930	394	ID/02609961	215	ID/02612099	170	ID/02628709	392
ID/02517931	390	ID/02609962	150	ID/02612138	185	ID/02628711	298
ID/02517947	87	ID/02609963	150	ID/02612144	459	ID/02628712	392
ID/02517948	87	ID/02609964	149	ID/02612145	459	ID/02628713	392
ID/02517949	90	ID/02609965	150	ID/02612146	459	ID/02628715	298
ID/02517950	90	ID/02609966	150	ID/02612147	459	ID/02628716	392
ID/02517951	90	ID/02609967	149	ID/02612159	121	ID/02628717	403
ID/02517952	90	ID/02609968	149	ID/02612161	207	ID/02628718	403

INDEX PAR RÉFÉRENCES

ID/02628720	299	ID/02682277	209	ID/02736900	38	ID/02773007	240
ID/02628723	403	ID/02682278	209	ID/02736901	38	ID/02773008	240
ID/02628725	299	ID/02682286	258	ID/02736902	261	ID/02773193	120
ID/02628728	403	ID/02682287	258	ID/02736903	261	ID/02773194	206
ID/02628729	403	ID/02682288	258	ID/02736904	261	ID/02773195	230
ID/02628731	299	ID/02682292	258	ID/02736905	261	ID/02773200	184
ID/02628734	403	ID/02682293	258	ID/02736906	260	ID/02773201	184
ID/02628735	392	ID/02682294	258	ID/02736907	260	ID/02773203	334
ID/02628737	298	ID/02682295	258	ID/02736908	261	ID/02773203	352
ID/02628738	392	ID/02682296	258	ID/02736909	261	ID/02773204	352
ID/02628782	220	ID/02682297	258	ID/02736918	409	ID/02773205	334
ID/02628783	220	ID/02682298	258	ID/02736919	409	ID/02773207	348
ID/02628784	220	ID/02682299	258	ID/02736925	257	ID/02773216	236
ID/02628785	220	ID/02682315	54	ID/02736926	257	ID/02773217	236
ID/02628786	220	ID/02682316	54	ID/02740105	306	ID/02773229	113
ID/02628787	220	ID/02682349	80	ID/02740106	306	ID/02773230	113
ID/02628788	220	ID/02682350	80	ID/02741659	96	ID/02773231	113
ID/02628789	221	ID/02682353	93	ID/02748414	252	ID/02773232	113
ID/02628790	221	ID/02682354	91	ID/02748415	251	ID/02773233	113
ID/02628791	220	ID/02682355	91	ID/02748416	251	ID/02773234	113
ID/02640063	375	ID/02682394	405	ID/02748417	251	ID/02773235	113
ID/02640064	375	ID/02682395	405	ID/02748499	346	ID/02773236	208
ID/02640066	375	ID/02682396	405	ID/02748500	346	ID/02773237	208
ID/02640070	375	ID/02682397	405	ID/02748601	251	ID/02773238	179
ID/02640074	375	ID/02682402	405	ID/02748602	251	ID/02773239	181
ID/02640075	375	ID/02682403	405	ID/02748603	251	ID/02773268	459
ID/02640076	375	ID/02682404	405	ID/02748636	248	ID/02773269	459
ID/02640079	375	ID/02682405	405	ID/02748637	248	ID/02775556	270
ID/02644179	369	ID/02682408	395	ID/02748638	248	ID/02775558	270
ID/02644180	369	ID/02682410	342	ID/02748664	323	ID/02775559	270
ID/02644181	369	ID/02682522	93	ID/02752539	189	ID/02775560	270
ID/02646176	89	ID/02695324	172	ID/02752543	189	ID/02775561	270
ID/02646176	89	ID/02695325	172	ID/02761060	26	ID/02775562	48
ID/02661287	296	ID/02695326	172	ID/02761061	26	ID/02775563	48
ID/02661288	296	ID/02695327	232	ID/02761062	26	ID/02775564	48
ID/02661291	305	ID/02695349	237	ID/02761063	26	ID/02775877	444
ID/02661292	305	ID/02695370	238	ID/02761064	26	ID/02775878	444
ID/02661691	372	ID/02695401	108	ID/02761065	26	ID/02775879	444
ID/02661692	373	ID/02695402	108	ID/02761066	27	ID/02775880	444
ID/02661693	373	ID/02695403	109	ID/02761067	27	ID/02775887	445
ID/02661694	373	ID/02695404	109	ID/02761069	27	ID/02775899	446
ID/02661695	373	ID/02695405	303	ID/02761070	27	ID/02775900	448
ID/02661696	373	ID/02695431	459	ID/02761071	27	ID/02775905	446
ID/02679170	323	ID/02695450	120	ID/02761072	27	ID/02775906	448
ID/02679178	50	ID/02695451	120	ID/02761073	24	ID/02775909	446
ID/02679179	50	ID/02731368	103	ID/02761073	27	ID/02775910	448
ID/02679184	313	ID/02731369	425	ID/02761074	24	ID/02775911	446
ID/02679185	313	ID/02731370	294	ID/02761074	27	ID/02775913	446
ID/02679186	313	ID/02732224	432	ID/02769195	119	ID/02775915	446
ID/02679187	313	ID/02732236	432	ID/02769199	119	ID/02775921	448
ID/02679188	197	ID/02732247	432	ID/02769203	119	ID/02775927	447
ID/02679189	197	ID/02736492	327	ID/02769210	119	ID/02775927	448
ID/02682234	157	ID/02736495	327	ID/02769217	119	ID/02775947	447
ID/02682235	157	ID/02736498	327	ID/02769324	191	ID/02777702	410
ID/02682236	157	ID/02736883	16	ID/02769328	191	ID/02777703	410
ID/02682256	213	ID/02736884	16	ID/02769332	191	ID/02777704	410
ID/02682257	198	ID/02736885	16	ID/02772924	162	ID/02777705	410
ID/02682258	198	ID/02736886	16	ID/02772929	184	ID/02777706	410
ID/02682261	214	ID/02736887	17	ID/02772930	184	ID/02778449	452
ID/02682263	215	ID/02736888	17	ID/02772931	184	ID/02778451	453
ID/02682264	216	ID/02736889	38	ID/02772932	184	ID/02778452	452
ID/02682265	216	ID/02736890	38	ID/02772939	171	ID/02778455	453
ID/02682266	216	ID/02736891	38	ID/02772940	171	ID/02778456	453
ID/02682267	216	ID/02736892	38	ID/02772941	171	ID/02785633	96
ID/02682268	216	ID/02736893	38	ID/02772956	233	ID/02785634	96
ID/02682269	39	ID/02736894	38	ID/02772957	233	ID/02786392	80
ID/02682270	39	ID/02736895	38	ID/02772958	233	ID/02786393	80
ID/02682271	39	ID/02736896	38	ID/02772959	228	ID/02786394	90
ID/02682272	39	ID/02736897	38	ID/02772968	228	ID/02786401	343
ID/02682273	312	ID/02736898	38	ID/02773005	200	ID/02786402	343
ID/02682274	312	ID/02736899	38	ID/02773006	200	ID/02786404	174

INDEX PAR RÉFÉRENCES

ID/02786405	174	ID/02866165	192	ID/02878404	207	ID/02955261	63
ID/02786406	174	ID/02866166	192	ID/02878461	146	ID/02955279	63
ID/02786407	174	ID/02866167	192	ID/02878462	146	ID/02955281	63
ID/02786408	174	ID/02866168	192	ID/02878463	146	ID/03000210	119
ID/02786409	174	ID/02866169	192	ID/02878464	146	ID/03000218	119
ID/02786410	174	ID/02866170	192	ID/02878465	146	ID/03000226	119
ID/02786411	174	ID/02866171	192	ID/02878466	146	ID/03000240	119
ID/02786420	217	ID/02866306	102	ID/02878467	146	ID/03000254	119
ID/02786421	217	ID/02866307	102	ID/02878468	146	ID/03004737	191
ID/02786422	217	ID/02866308	102	ID/02878562	377	ID/03004745	191
ID/02786423	217	ID/02866309	102	ID/02878658	365	ID/03004753	191
ID/02786424	140	ID/02866310	102	ID/02878664	346	ID/03126138	188
ID/02786425	140	ID/02866311	102	ID/02878678	180	ID/03126139	188
ID/02786426	140	ID/02866441	193	ID/02878679	180	ID/03126140	188
ID/02786427	140	ID/02866443	193	ID/02878681	180	ID/03126141	188
ID/02792008	20	ID/02866444	193	ID/02878682	180	ID/03126142	188
ID/02792009	96	ID/02866445	193	ID/02879043	241	ID/03126143	188
ID/02792010	96	ID/02866449	193	ID/02879044	183	ID/03126144	188
ID/02792649	306	ID/02867344	10	ID/02879047	241	ID/03126145	188
ID/02797984	17	ID/02867345	10	ID/02879048	183	ID/03126148	118
ID/02797989	454	ID/02867346	10	ID/02879153	147	ID/03126149	118
ID/02799458	421	ID/02870401	350	ID/02879154	147	ID/03126150	118
ID/02799459	421	ID/02870401	350	ID/02879155	147	ID/03126151	118
ID/02799460	421	ID/02870401	351	ID/02879156	147	ID/03126152	118
ID/02799461	421	ID/02870402	351	ID/02879157	200	ID/03126153	118
ID/02802274	420	ID/02870403	351	ID/02879159	147	ID/03126154	118
ID/02802275	420	ID/02870404	351	ID/02879160	147	ID/03126155	118
ID/02802276	420	ID/02870405	351	ID/02879161	147	ID/03126156	273
ID/02802446	421	ID/02870406	351	ID/02879162	147	ID/03126156	275
ID/02802495	421	ID/02870407	350	ID/02879163	200	ID/03126157	273
ID/02802496	421	ID/02870408	350	ID/02949541	134	ID/03126157	275
ID/02802497	421	ID/02870409	350	ID/02949547	134	ID/03126158	273
ID/02802518	420	ID/02870410	350	ID/02949559	134	ID/03126158	275
ID/02802519	420	ID/02870411	350	ID/02949565	134	ID/03126183	264
ID/02802520	420	ID/02870412	350	ID/02949609	393	ID/03126184	264
ID/02802521	420	ID/02870413	350	ID/02949611	393	ID/03126185	264
ID/02845289	10	ID/02870414	350	ID/02949612	393	ID/03126186	264
ID/02845290	10	ID/02870415	350	ID/02949613	393	ID/03126189	265
ID/02845291	10	ID/02870416	350	ID/02949614	393	ID/03126190	265
ID/02845292	8	ID/02877017	294	ID/02949615	393	ID/03126191	265
ID/02846121	22	ID/02877018	294	ID/02949616	60	ID/03126192	265
ID/02846122	22	ID/02877019	425	ID/02949617	60	ID/03126195	266
ID/02846123	22	ID/02877020	425	ID/02949636	61	ID/03126196	266
ID/02846124	22	ID/02877794	241	ID/02949636	404	ID/03126197	266
ID/02846135	17	ID/02877795	183	ID/02949637	61	ID/03126198	266
ID/02846136	17	ID/02877798	241	ID/02949637	404	ID/03126215	272
ID/02846137	17	ID/02877799	183	ID/02949638	61	ID/03126218	272
ID/02846138	17	ID/02877800	183	ID/02949638	404	ID/03126219	257
ID/02846139	17	ID/02877803	241	ID/02949639	61	ID/03126220	257
ID/02846143	314	ID/02877804	183	ID/02949639	404	ID/03126221	272
ID/02846144	314	ID/02877805	183	ID/02949640	61	ID/03126222	272
ID/02846145	91	ID/02877862	320	ID/02949640	404	ID/03126223	272
ID/02846147	50	ID/02877863	320	ID/02949641	61	ID/03126224	272
ID/02846148	50	ID/02877866	346	ID/02949641	404	ID/03126225	272
ID/02846149	50	ID/02877889	109	ID/02949642	61	ID/03126225	274
ID/02846150	50	ID/02877890	109	ID/02949642	404	ID/03126226	272
ID/02846154	409	ID/02877891	109	ID/02949643	61	ID/03126226	274
ID/02846155	409	ID/02877892	109	ID/02949643	404	ID/03126227	272
ID/02866132	192	ID/02877893	108	ID/02949644	61	ID/03126227	274
ID/02866133	192	ID/02877894	108	ID/02949644	404	ID/03126228	272
ID/02866134	192	ID/02877895	108	ID/02949773	221	ID/03126228	274
ID/02866135	192	ID/02877896	108	ID/02949774	220	ID/03126229	272
ID/02866136	192	ID/02877897	108	ID/02953790	63	ID/03126229	274
ID/02866137	192	ID/02877898	108	ID/02953792	63	ID/03126230	272
ID/02866138	192	ID/02878253	221	ID/02953808	63	ID/03126231	272
ID/02866139	192	ID/02878254	221	ID/02953810	63	ID/03126231	274
ID/02866140	192	ID/02878255	221	ID/02953826	63	ID/03126232	273
ID/02866141	192	ID/02878256	221	ID/02953828	63	ID/03126232	274
ID/02866162	192	ID/02878257	221	ID/02955239	63	ID/03126233	273
ID/02866163	192	ID/02878258	221	ID/02955241	63	ID/03126233	275
ID/02866164	192	ID/02878402	207	ID/02955259	63	ID/03126234	273

INDEX PAR RÉFÉRENCES

ID/03126234	275	ID/03126305	266	ID/03126550	67	ID/03129064	36
ID/03126235	274	ID/03126306	266	ID/03126552	67	ID/03129065	36
ID/03126236	274	ID/03126307	264	ID/03126554	67	ID/03129066	36
ID/03126237	274	ID/03126308	264	ID/03126580	65	ID/03129067	36
ID/03126238	274	ID/03126309	264	ID/03126582	65	ID/03129068	454
ID/03126239	274	ID/03126310	264	ID/03126584	65	ID/03129069	454
ID/03126240	274	ID/03126311	265	ID/03126586	65	ID/03129070	36
ID/03126241	285	ID/03126312	265	ID/03126588	65	ID/03129071	36
ID/03126242	285	ID/03126313	265	ID/03126590	65	ID/03130735	96
ID/03126243	285	ID/03126314	265	ID/03126616	67	ID/03136827	103
ID/03126244	285	ID/03126315	266	ID/03126618	67	ID/03136828	293
ID/03126245	284	ID/03126316	266	ID/03126620	67	ID/03136829	103
ID/03126246	284	ID/03126317	266	ID/03126622	67	ID/03136830	293
ID/03126247	284	ID/03126318	266	ID/03126624	67	ID/03136831	103
ID/03126248	284	ID/03126319	264	ID/03126626	67	ID/03136832	293
ID/03126249	284	ID/03126320	265	ID/03126652	69	ID/03136833	103
ID/03126250	284	ID/03126321	266	ID/03126654	69	ID/03136834	293
ID/03126251	282	ID/03126322	264	ID/03126656	69	ID/03158945	362
ID/03126252	282	ID/03126323	265	ID/03126658	69	ID/03158946	362
ID/03126253	282	ID/03126324	266	ID/03126660	69	ID/03158947	362
ID/03126254	282	ID/03126325	264	ID/03126662	69	ID/03158948	362
ID/03126255	282	ID/03126326	265	ID/03126688	69	ID/03158949	363
ID/03126256	282	ID/03126327	266	ID/03126690	69	ID/03158950	363
ID/03126257	282	ID/03126328	264	ID/03126692	69	ID/03170075	159
ID/03126258	282	ID/03126329	265	ID/03126694	69	ID/03170090	136
ID/03126259	276	ID/03126330	266	ID/03126696	69	ID/03170091	136
ID/03126260	276	ID/03126352	64	ID/03126698	69	ID/03170092	136
ID/03126261	276	ID/03126354	64	ID/03126800	304	ID/03170093	136
ID/03126262	276	ID/03126356	64	ID/03126802	336	ID/03170094	136
ID/03126263	276	ID/03126358	64	ID/03126803	336	ID/03170095	136
ID/03126264	276	ID/03126360	64	ID/03126807	305	ID/03170096	136
ID/03126265	277	ID/03126362	64	ID/03128838	368	ID/03170097	136
ID/03126266	277	ID/03126376	66	ID/03128839	368	ID/03170108	377
ID/03126267	277	ID/03126378	66	ID/03128868	13	ID/03170109	401
ID/03126268	277	ID/03126380	66	ID/03128888	16	ID/03170132	163
ID/03126269	277	ID/03126382	66	ID/03128889	16	ID/03170141	143
ID/03126270	277	ID/03126384	66	ID/03128890	16	ID/03170142	143
ID/03126271	279	ID/03126386	66	ID/03128891	16	ID/03170143	143
ID/03126272	279	ID/03126400	64	ID/03128892	17	ID/03170144	143
ID/03126273	279	ID/03126402	64	ID/03128893	17	ID/03170145	143
ID/03126274	279	ID/03126404	64	ID/03128894	17	ID/03170146	143
ID/03126275	279	ID/03126406	64	ID/03128895	17	ID/03170147	143
ID/03126276	279	ID/03126408	64	ID/03128896	17	ID/03170148	143
ID/03126277	278	ID/03126410	64	ID/03128898	261	ID/03170158	336
ID/03126278	278	ID/03126424	66	ID/03128899	261	ID/03170195	158
ID/03126279	278	ID/03126426	66	ID/03128910	408	ID/03170196	158
ID/03126280	278	ID/03126428	66	ID/03128911	408	ID/03170197	158
ID/03126281	279	ID/03126430	66	ID/03128912	408	ID/03170198	158
ID/03126282	279	ID/03126432	66	ID/03128913	408	ID/03170199	204
ID/03126283	279	ID/03126434	66	ID/03128914	408	ID/03170200	204
ID/03126284	279	ID/03126448	68	ID/03128915	408	ID/03174633	139
ID/03126285	279	ID/03126450	68	ID/03128916	408	ID/03174642	414
ID/03126286	279	ID/03126452	68	ID/03128917	408	ID/03174643	414
ID/03126287	287	ID/03126454	68	ID/03128918	408	ID/03174669	323
ID/03126288	287	ID/03126456	68	ID/03128919	408	ID/03174670	323
ID/03126289	287	ID/03126458	68	ID/03128920	408	ID/03174671	72
ID/03126290	287	ID/03126472	68	ID/03128921	408	ID/03174672	72
ID/03126291	289	ID/03126474	68	ID/03128928	409	ID/03174673	107
ID/03126292	289	ID/03126476	68	ID/03128929	409	ID/03174674	107
ID/03126293	289	ID/03126478	68	ID/03129051	34	ID/03174675	107
ID/03126294	289	ID/03126480	68	ID/03129052	34	ID/03174686	189
ID/03126295	264	ID/03126482	68	ID/03129053	34	ID/03174687	189
ID/03126296	264	ID/03126508	65	ID/03129054	34	ID/03174692	126
ID/03126297	264	ID/03126510	65	ID/03129055	35	ID/03174693	126
ID/03126298	264	ID/03126512	65	ID/03129056	35	ID/03174694	126
ID/03126299	265	ID/03126514	65	ID/03129057	35	ID/03174695	126
ID/03126300	265	ID/03126516	65	ID/03129059	35	ID/03222460	249
ID/03126301	265	ID/03126518	65	ID/03129060	35	ID/03223712	304
ID/03126302	265	ID/03126544	67	ID/03129061	35	ID/03223712	414
ID/03126303	266	ID/03126546	67	ID/03129062	35	ID/03223714	304
ID/03126304	266	ID/03126548	67	ID/03129063	35	ID/03223714	415

INDEX PAR RÉFÉRENCES

ID/03223716	304	ID/03274846	460	ID/03313330	319	ID/03362133	205
ID/03223716	415	ID/03274847	459	ID/03313478	319	ID/03362134	205
ID/03223877	292	ID/03274848	459	ID/03328586	217	ID/03362401	431
ID/03223878	292	ID/03274849	459	ID/03328602	385	ID/03362402	431
ID/03223879	292	ID/03286948	52	ID/03328604	382	ID/03362409	431
ID/03223880	292	ID/03286949	53	ID/03328609	388	ID/03362410	431
ID/03223881	292	ID/03286953	62	ID/03328610	388	ID/03363088	412
ID/03223882	292	ID/03286954	62	ID/03328654	84	ID/03363089	412
ID/03224838	176	ID/03286955	62	ID/03328655	84	ID/03363090	412
ID/03224839	177	ID/03286956	62	ID/03328656	84	ID/03363091	412
ID/03224854	180	ID/03286957	62	ID/03328657	84	ID/03363092	412
ID/03224855	180	ID/03286958	62	ID/03351984	410	ID/03363093	412
ID/03224856	180	ID/03286959	62	ID/03361314	187	ID/03363094	412
ID/03224857	180	ID/03286960	62	ID/03361315	187	ID/03363095	412
ID/03224863	222	ID/03286961	62	ID/03361317	212	ID/03382579	381
ID/03224864	222	ID/03286962	62	ID/03361318	212	ID/03382580	381
ID/03224865	222	ID/03286963	62	ID/03361319	212	ID/03382581	380
ID/03224866	222	ID/03286964	62	ID/03361703	224	ID/03382582	380
ID/03224867	222	ID/03286972	293	ID/03361704	224	ID/03382583	380
ID/03224868	222	ID/03286975	333	ID/03361705	225	ID/03382584	380
ID/03232780	96	ID/03286976	333	ID/03361706	225	ID/03382621	162
ID/03232781	96	ID/03286977	333	ID/03361707	225	ID/03382624	186
ID/03233424	97	ID/03286978	333	ID/03361708	225	ID/03382628	158
ID/03233426	97	ID/03286979	333	ID/03361712	160	ID/03382629	158
ID/03233448	97	ID/03286980	333	ID/03361712	254	ID/03382630	159
ID/03233450	97	ID/03286981	378	ID/03361713	160	ID/03382631	159
ID/03234010	24	ID/03286982	378	ID/03361713	254	ID/03382643	137
ID/03234010	27	ID/03286983	378	ID/03361714	160	ID/03382644	137
ID/03234385	446	ID/03286984	382	ID/03361714	254	ID/03382645	137
ID/03234385	447	ID/03286985	325	ID/03361715	160	ID/03382646	137
ID/03234385	448	ID/03286986	325	ID/03361715	254	ID/03382647	137
ID/03234386	446	ID/03286987	376	ID/03361718	161	ID/03382648	137
ID/03234386	447	ID/03286988	301	ID/03361718	255	ID/03382649	171
ID/03234386	448	ID/03286989	340	ID/03361719	161	ID/03382650	171
ID/03234387	447	ID/03286990	333	ID/03361719	255	ID/03382657	203
ID/03234387	448	ID/03286991	110	ID/03361722	161	ID/03382658	203
ID/03234388	446	ID/03286993	271	ID/03361722	211	ID/03382659	164
ID/03234388	447	ID/03286994	271	ID/03361722	255	ID/03382660	164
ID/03234388	449	ID/03286995	271	ID/03361723	161	ID/03382661	229
ID/03234389	446	ID/03286996	271	ID/03361723	211	ID/03382662	229
ID/03234389	447	ID/03298302	440	ID/03361723	255	ID/03382663	229
ID/03234389	449	ID/03298303	440	ID/03361724	161	ID/03382664	229
ID/03234390	447	ID/03298304	438	ID/03361724	211	ID/03382777	273
ID/03234390	449	ID/03298305	441	ID/03361724	255	ID/03382777	275
ID/03234414	444	ID/03298306	439	ID/03361725	161	ID/03382778	273
ID/03234422	445	ID/03298307	439	ID/03361725	211	ID/03382778	275
ID/03234423	445	ID/03298308	439	ID/03361725	255	ID/03382780	93
ID/03234424	445	ID/03298309	439	ID/03361726	161	ID/03382781	91
ID/03274700	137	ID/03298584	221	ID/03361726	211	ID/03382782	52
ID/03274701	137	ID/03298585	221	ID/03361726	255	ID/03382783	53
ID/03274702	137	ID/03298586	221	ID/03361727	161	ID/03382784	49
ID/03274703	137	ID/03298600	411	ID/03361727	211	ID/03382785	49
ID/03274724	204	ID/03298601	410	ID/03361727	255	ID/03382786	52
ID/03274725	145	ID/03298602	411	ID/03361728	161	ID/03382787	52
ID/03274726	145	ID/03298603	410	ID/03361728	255	ID/03382788	53
ID/03274727	141	ID/03298604	410	ID/03361729	161	ID/03382789	53
ID/03274728	141	ID/03298605	411	ID/03361729	255	ID/03382795	56
ID/03274729	141	ID/03298606	410	ID/03361730	161	ID/03382796	56
ID/03274730	141	ID/03298607	411	ID/03361730	255	ID/03382797	56
ID/03274731	141	ID/03298608	410	ID/03361731	161	ID/03382799	56
ID/03274732	141	ID/03298609	411	ID/03361731	255	ID/03382800	56
ID/03274733	141	ID/03298610	410	ID/03361732	161	ID/03382801	56
ID/03274734	141	ID/03298611	411	ID/03361732	255	ID/03382802	56
ID/03274832	461	ID/03298640	60	ID/03361733	161	ID/03382804	56
ID/03274833	461	ID/03298641	60	ID/03361733	255	ID/03382810	57
ID/03274834	461	ID/03298642	60	ID/03361735	210	ID/03382811	57
ID/03274836	459	ID/03298643	60	ID/03361737	210	ID/03382812	57
ID/03274837	459	ID/03298644	60	ID/03361742	210	ID/03382814	57
ID/03274840	459	ID/03298645	60	ID/03361743	210	ID/03382815	57
ID/03274841	459	ID/03298646	60	ID/03362131	205	ID/03382816	57
ID/03274842	459	ID/03313309	319	ID/03362132	205	ID/03382817	57

INDEX PAR RÉFÉRENCES

ID/03382819	57	ID/03382960	277	ID/03383169	107	ID/03468565	88
ID/03382820	56	ID/03382961	277	ID/03383169	402	ID/03468566	88
ID/03382821	56	ID/03382962	277	ID/03383173	366	ID/03468567	89
ID/03382822	56	ID/03382963	278	ID/03383185	21	ID/03468568	89
ID/03382824	56	ID/03382964	278	ID/03383186	20	ID/03468591	88
ID/03382825	57	ID/03382965	278	ID/03383194	111	ID/03468592	88
ID/03382826	57	ID/03382966	278	ID/03383195	111	ID/03468617	88
ID/03382827	57	ID/03382967	287	ID/03383196	111	ID/03468618	88
ID/03382829	57	ID/03382968	287	ID/03383197	111	ID/03468645	89
ID/03382834	70	ID/03382969	287	ID/03383220	107	ID/03468646	89
ID/03382835	70	ID/03382970	287	ID/03383221	107	ID/03468647	89
ID/03382836	70	ID/03382971	289	ID/03383222	107	ID/03468648	89
ID/03382837	70	ID/03382972	289	ID/03383232	112	ID/03468671	438
ID/03382838	58	ID/03382973	289	ID/03383233	112	ID/03468672	438
ID/03382839	58	ID/03382974	289	ID/03383234	112	ID/03468673	438
ID/03382840	58	ID/03382975	271	ID/03383235	112	ID/03468676	440
ID/03382841	58	ID/03382976	271	ID/03383236	178	ID/03468677	440
ID/03382842	58	ID/03382977	271	ID/03383237	178	ID/03468677	354
ID/03382843	58	ID/03382978	271	ID/03383238	178	ID/03468777	353
ID/03382844	58	ID/03382979	259	ID/03383239	178	ID/03468779	48
ID/03382845	58	ID/03382980	259	ID/03383242	105	ID/03468785	109
ID/03382846	59	ID/03382983	281	ID/03383243	105	ID/03468786	109
ID/03382847	59	ID/03382984	281	ID/03383244	105	ID/03468787	108
ID/03382848	59	ID/03382985	281	ID/03383245	105	ID/03468788	108
ID/03382849	59	ID/03382986	281	ID/03383246	105	ID/03468789	108
ID/03382850	59	ID/03382987	281	ID/03383247	105	ID/03468840	303
ID/03382851	59	ID/03382988	281	ID/03383250	104	ID/03468842	303
ID/03382852	59	ID/03382989	280	ID/03383251	104	ID/03468845	176
ID/03382853	59	ID/03382990	280	ID/03383252	104	ID/03468846	177
ID/03382860	71	ID/03382991	286	ID/03383253	104	ID/03468847	177
ID/03382861	71	ID/03382992	286	ID/03383254	104	ID/03468848	177
ID/03382891	244	ID/03382997	268	ID/03383255	104	ID/03468849	177
ID/03382893	324	ID/03382998	268	ID/03383262	127	ID/03468850	177
ID/03382894	324	ID/03382999	268	ID/03383263	127	ID/03468851	177
ID/03382895	324	ID/03383000	268	ID/03383264	127	ID/03468852	177
ID/03382896	324	ID/03383001	268	ID/03383265	127	ID/03468872	402
ID/03382897	325	ID/03383002	268	ID/03383266	127	ID/03468874	399
ID/03382900	395	ID/03383003	268	ID/03383267	127	ID/03468875	399
ID/03382903	342	ID/03383004	268	ID/03383268	127	ID/03468878	182
ID/03382905	245	ID/03383008	214	ID/03383269	127	ID/03468879	182
ID/03382908	297	ID/03383009	214	ID/03383270	156	ID/03468880	182
ID/03382909	297	ID/03383010	138	ID/03383271	156	ID/03469047	460
ID/03382910	297	ID/03383011	138	ID/03383272	156	ID/03469113	460
ID/03382911	297	ID/03383028	138	ID/03383273	156	ID/03469159	460
ID/03382933	285	ID/03383029	138	ID/03383274	156	ID/03471856	416
ID/03382934	285	ID/03383030	133	ID/03383275	156	ID/03471873	427
ID/03382935	285	ID/03383032	133	ID/03383276	142	ID/03472891	422
ID/03382936	285	ID/03383033	244	ID/03383277	142	ID/03472892	422
ID/03382937	284	ID/03383034	244	ID/03383278	142	ID/03472893	422
ID/03382938	284	ID/03383035	244	ID/03383279	142	ID/03472894	422
ID/03382939	284	ID/03383036	244	ID/03383280	142	ID/03472895	422
ID/03382940	284	ID/03383037	244	ID/03383281	142	ID/03472896	422
ID/03382941	284	ID/03383038	244	ID/03383282	126	ID/03472897	426
ID/03382942	284	ID/03383039	244	ID/03383283	126	ID/03472898	422
ID/03382943	282	ID/03383040	244	ID/03383284	127	ID/03472898	427
ID/03382944	282	ID/03383041	214	ID/03383285	127	ID/03472899	426
ID/03382945	282	ID/03383042	214	ID/03383286	127	ID/03472900	426
ID/03382946	282	ID/03383043	138	ID/03468467	88	ID/03472901	426
ID/03382947	282	ID/03383044	138	ID/03468467	88	ID/03472903	427
ID/03382948	282	ID/03383045	133	ID/03468523	74	ID/03472904	423
ID/03382949	282	ID/03383046	133	ID/03468523	132	ID/03472905	423
ID/03382950	282	ID/03383047	133	ID/03468524	74	ID/03473172	102
ID/03382951	276	ID/03383048	133	ID/03468524	132	ID/03473173	424
ID/03382952	276	ID/03383104	50	ID/03468525	74	ID/03473174	292
ID/03382953	276	ID/03383105	50	ID/03468525	132	ID/03473175	424
ID/03382954	276	ID/03383111	315	ID/03468526	74	ID/03473176	102
ID/03382955	276	ID/03383112	315	ID/03468526	132	ID/03473177	424
ID/03382956	276	ID/03383113	315	ID/03468527	74	ID/03473178	292
ID/03382957	277	ID/03383114	315	ID/03468527	132	ID/03473179	424
ID/03382958	277	ID/03383168	107	ID/03468528	74	ID/03473180	102
ID/03382959	277	ID/03383168	402	ID/03468528	132	ID/03473181	424

INDEX PAR RÉFÉRENCES

ID/03473182.....	292	ID/03517643.....	45	ID/03546867.....	51
ID/03473183.....	424	ID/03517644.....	45	ID/03546868.....	51
ID/03473184.....	102	ID/03517645.....	45	ID/03546869.....	51
ID/03473185.....	424	ID/03517646.....	45	ID/03546870.....	51
ID/03473186.....	292	ID/03517647.....	45	ID/03546874.....	417
ID/03473187.....	424	ID/03517648.....	45	ID/03546875.....	417
ID/03473221.....	74	ID/03517649.....	45	ID/03546876.....	349
ID/03473222.....	74	ID/03544751.....	431	ID/03546877.....	349
ID/03473223.....	74	ID/03544752.....	431	ID/03546912.....	19
ID/03473224.....	74	ID/03546421.....	89	ID/03546913.....	19
ID/03473225.....	74	ID/03546711.....	23	ID/03546923.....	349
ID/03473229.....	313	ID/03546712.....	24	ID/03546942.....	257
ID/03473230.....	313	ID/03546723.....	22	ID/03546943.....	257
ID/03481572.....	416	ID/03546724.....	22	ID/03546956.....	32
ID/03481601.....	445	ID/03546725.....	24	ID/03546957.....	32
ID/03482051.....	110	ID/03546729.....	24	ID/03546958.....	32
ID/03482641.....	432	ID/03546730.....	24	ID/03546959.....	455
ID/03482645.....	432	ID/03546733.....	24	ID/03546960.....	455
ID/03482649.....	432	ID/03546734.....	24	ID/03546968.....	91
ID/03482925.....	434	ID/03546740.....	20	ID/03546968.....	98
ID/03482929.....	434	ID/03546742.....	20	ID/03547712.....	51
ID/03482930.....	434	ID/03546743.....	20	ID/03547713.....	51
ID/03482931.....	434	ID/03546744.....	23	ID/03547714.....	51
ID/03482935.....	434	ID/03546745.....	23	ID/03547715.....	51
ID/03482936.....	434	ID/03546746.....	23	ID/03569117.....	430
ID/03482937.....	434	ID/03546747.....	23	ID/03569118.....	430
ID/03482941.....	434	ID/03546753.....	8	ID/03569119.....	430
ID/03482942.....	434	ID/03546754.....	9	ID/03574640.....	445
ID/03483056.....	96	ID/03546755.....	9	ID/03574644.....	445
ID/03483057.....	96	ID/03546756.....	9	ID/03576252.....	446
ID/03483163.....	413	ID/03546757.....	13	ID/03576253.....	448
ID/03483164.....	413	ID/03546759.....	9	ID/03576254.....	446
ID/03483167.....	413	ID/03546760.....	9	ID/03576256.....	448
ID/03483168.....	413	ID/03546761.....	9	ID/03576257.....	447
ID/03483171.....	413	ID/03546762.....	9	ID/03576259.....	447
ID/03483172.....	413	ID/03546763.....	9	ID/03582870.....	132
ID/03483175.....	413	ID/03546764.....	12	ID/03582871.....	132
ID/03483176.....	413	ID/03546768.....	14	ID/03582872.....	132
ID/03503732.....	421	ID/03546769.....	14	ID/03582873.....	132
ID/03503778.....	421	ID/03546770.....	14	ID/03582874.....	132
ID/03503945.....	421	ID/03546771.....	14	ID/03582875.....	132
ID/03517613.....	46	ID/03546772.....	14	ID/03582876.....	132
ID/03517614.....	46	ID/03546773.....	14	ID/03582877.....	132
ID/03517615.....	46	ID/03546780.....	10	ID/03582878.....	132
ID/03517616.....	46	ID/03546781.....	10	ID/03582927.....	433
ID/03517617.....	46	ID/03546782.....	10	ID/03582928.....	433
ID/03517618.....	46	ID/03546783.....	11	ID/03582930.....	444
ID/03517619.....	46	ID/03546784.....	11	ID/03582932.....	447
ID/03517620.....	46	ID/03546785.....	11	ID/03582933.....	444
ID/03517621.....	46	ID/03546786.....	9	ID/03582944.....	24
ID/03517622.....	46	ID/03546787.....	9	ID/03582945.....	24
ID/03517623.....	46	ID/03546788.....	9	ID/03583191.....	451
ID/03517624.....	46	ID/03546789.....	9	ID/03583193.....	451
ID/03517625.....	47	ID/03546803.....	6	ID/03583195.....	451
ID/03517626.....	47	ID/03546804.....	6	ID/03598519.....	446
ID/03517627.....	47	ID/03546805.....	6	ID/03598523.....	435
ID/03517628.....	47	ID/03546806.....	6	ID/03598524.....	435
ID/03517629.....	44	ID/03546807.....	6	ID/03598526.....	161
ID/03517630.....	44	ID/03546808.....	6	ID/03598526.....	255
ID/03517631.....	44	ID/03546809.....	6	ID/03598527.....	161
ID/03517632.....	44	ID/03546810.....	6	ID/03598527.....	255
ID/03517633.....	44	ID/03546850.....	260	ID/03598528.....	161
ID/03517634.....	44	ID/03546851.....	261	ID/03598528.....	255
ID/03517635.....	44	ID/03546857.....	96	ID/03598529.....	161
ID/03517636.....	44	ID/03546858.....	98	ID/03598529.....	255
ID/03517637.....	44	ID/03546859.....	91		
ID/03517638.....	45	ID/03546860.....	91		
ID/03517639.....	45	ID/03546862.....	445		
ID/03517640.....	45	ID/03546863.....	445		
ID/03517641.....	45	ID/03546864.....	445		
ID/03517642.....	45	ID/03546866.....	51		

NOS PARTENAIRES DU CATALOGUE

ares
THE OUTDOOR BY FLOS

INDIGO
LIGHTING

PERFORMANCE
IN LIGHTING

BEL LIGHTING

IP44.DE

ROGER PRADIER

Beghelli

LUÇIDE

secom
here comes the light

CASAMBI

LCI
LIGHTING COMPANY ITALY

sg

CILUX

LEDVANCE

SLV

DELTA LIGHT

LEDS C4

TAL
TECHNICAL
ARCHITECTURAL
LIGHTING

DOXIS
LIGHTING FACTORY

LINERGY
EMERGENCY LIGHTING

Teconex

exenia
part of the lumenpulse
GROUP

LITEGEAR
LED Lighting with Safety

TerZoLight

fantasia
light designers

nalv

UNI-BRIGHT

HUPPERTZ

niko

vander elst
CONNECTING SOLUTIONS

IDT LIGHT

















CGGI
INFINITY LIGHTING

WEVER & DUCRÉ
LIGHTING

NOTES

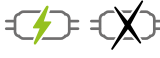
A series of horizontal dotted lines for writing notes.

PICTOGRAMMES

LED	Luminaire équipé d'une source LED intégrée		Peut être recouvert d'un isolant oui / non
5 ANS	Garantie Pour tout article sans indication de garantie, la durée de garantie légale de 2 ans est d'application.		Luminaire équipé d'une source Dim-to-warm
	Gestion d'éclairage par Bluetooth		Type de dimming
	Indice de protection contre les poussières et l'eau		Montage mur/sol/plafond encastré
	Luminaire équipé d'un interrupteur		Montage mur/sol/plafond apparent
	Ampoule incluse ou non incluse		Classe énergétique
	Convient pour la salle de bain		Orientation(s) du ou des faisceau(x)
	Angle de rotation		Alimentation électrique incluse ou exclue
	Angle du faisceau lumineux	230V 24V	Tension
IRC 80	Indice de rendu des couleurs		Convient à un usage intérieur ou extérieur
	Indice de protection mécanique IKXX		

Les prix indiqués sont des prix publics hors T.V.A. Ceux-ci sont susceptibles de variations.
Les photos et descriptions sont données à titre indicatif.



Imprimé sur papier certifié PEFC, utilisation d'encre à base Végétales
Imprimé par Excellence Print - Bietlot, Stavelot certifié Imprim'vert.

VOTRE PROJET D'ÉCLAIRAGE, C'EST NOTRE AFFAIRE

MAISONS - COMMERCE - HÔTELS - RESTAURANTS - ENTREPRISES - ...

Depuis près de 25 ans, Illudesign offre son expertise d'éclairagiste pour tous les projets privés, commerciaux, tertiaires, publics, industriels... Le groupe Illudesign réunit 50 collaborateurs, 4 showrooms de près de 3000m² en Belgique et au Grand-Duché du Luxembourg et présente la plus large gamme imaginable en éclairage décoratif, architectural et technique.

UNE QUESTION, UN CONSEIL, UNE DEMANDE PARTICULIÈRE?

Nos équipes sont à votre écoute au +32(0)4 361 15 33
ou par mail à eweb@illudesign.be



CONSEIL EN SHOWROOM

Trouver ou renouveler le luminaire d'une pièce ? Venez visiter l'un de nos 4 showrooms, nos conseillers vous guideront selon vos besoins, vos envies, votre budget.



ESPACE SELF-SERVICE

Une belle sélection de luminaires intérieurs/ extérieurs à l'excellent rapport qualité-prix-design. Ici, vous emportez immédiatement les solutions lumineuses adéquates pour votre projet.



ÉTUDES ET PROJETS

Mettre en lumière votre habitation, votre commerce, vos espaces professionnels, tertiaires ou industriels ? Prenez rdv avec un conseiller éclairagiste de nos bureaux d'étude.



TECHNICO-COMMERCIAUX

Installateur, entrepreneur, architecte, bureau d'étude... ? Vous cherchez un partenaire de confiance pour la partie éclairage et matériel électrique de vos activités ? Contactez nos technico-commerciaux.



COMPTOIR TECHNIQUE

Du matériel électrique (câbles, interrupteurs, domotique, parlophonie, chauffage...) et des conseils pour vos petits et grands chantiers que vous soyez privé ou professionnel.



ILLUBOX

Professionnel ? 24h/24, 7j/7, enlevez vos commandes de luminaires et matériel électrique dans nos espaces sécurisés: les ILLUBOX PRO.



RAISONNONS RÉSEAUX !

Vous avez réalisé un projet avec nos produits ?
Stimulons l'inspiration en le partageant ensemble sur Facebook, Instagram, LinkedIn.
Mettons-nous en contact ! Écrivez-nous à marketing@illudesign.be.



ILLUDESIGN
— PASSION OF LIGHT —

RUE DIGUETTE, 1
B-4031 ANGLEUR-LIÈGE
BELGIQUE

Tel. : +32(0)4 361 15 33
liege@illudesign.be

ROUTE DE SAUSSIN, 44 B2
B-5190 SPY
BELGIQUE

Tel. : +32(0)71 15 82 82
spy@illudesign.be

CHAUSSÉE DE LOUVAIN, 473 B2
B-1300 WAVRE
BELGIQUE

Tel. : +32(0)10 22 43 93
wavre@illudesign.be

ROUTE D'ARLON 321
L-8011 STRASSEN
LUXEMBOURG

Tel. : +352(0)20 33 15 26
strassen@illudesign.lu

VISUALISEZ NOTRE CATALOGUE EN LIGNE
WWW.ILLUDESIGN.BE

